



GALAKSI FREEDOM SERIES



2024 - 2025

**Professional LED Lighting Fixtures
Luminaire Professionnels LED**

MODERN LIGHTING FIXTURES LUMINAIRES MODERNES



Factory / Usine

KONYA/TURKEY



ABOUT US

PAMIR ELEKTRİK is located in the industrial city of KONYA, in the heart of Anatolia.

Created in 1974, it was manufacturing originally some electrical equipment. However, since 1990, it shifted its production solely towards the lighting sector, and became a specialist in this field.

It ranks today among the most performing Turkish companies in the sector, which offer a large array of products, combining aesthetic, quality and competitive price.

Range of products:

- LED and T5 Fluorescent lighting fixtures for offices and shopping places,
- IP67 LED Floodlights & High bay lights,
- IP65 LED and T5 Fluorescent High bay lighting fixtures,
- IP65 LED and T5, T8 Fluorescent Waterproof lighting fixtures,
- IP65 LED and T5, T8 Fluorescent ExProof lighting fixtures,
- Wallwashers,
- Downlights, track lights,
- Glop lamps,
- Motion sensor,
- Motion sensor lamps,

Our strengths:

PAMIR's catalogue offers a large variety of Elegant lighting fixtures, Proline lighting fixtures, circular lighting fixtures, wall lamps, waterproof lighting fixtures, motion sensor lamps... and accessories to be fitted either on the ceiling (suspended, recessed or surface mounted), or on the wall, all made with the finest materials and craftsmanship available.

We are able to conceive and offer products which combine both aesthetic and competitiveness, due to the fact that all the different stages – from conception to production are done in our factory.

All products are thought in our R&D department, by means of the latest softwares CAD/CAM and others, the moulds prepared in our own mould workshop, then once tested and approved, manufactured.

Every order – be it small or large – gets our personal attention and care down to the smallest details.

Whatever your lighting need may be, let us care for it. We have been in the business for nearly 40 years, and the repeated orders from our faithful clients both in Turkey and abroad are the best testimony for our quality and seriousness.

We will be very honoured to get to know you and serve you.

NOUS CONNAITRE

PAMIR ELEKTRİK est située dans la ville industrielle de KONYA, en plein centre de l'Anatolie.

Créée en 1974, elle produisait à l'origine des équipements électriques. Cependant, depuis 1990, elle s'est orientée exclusivement vers la fabrication de produits et accessoires d'éclairage.

Elle compte aujourd'hui parmi les entreprises turques les plus performantes et celles qui offrent une gamme de produits variés, alliant esthétique, qualité et prix.

Gamme de produits:

- Luminaires LED et Fluorescent T5 pour bureaux et commerces,
- Projecteurs à LED IP67 et luminaires grande hauteur,
- Appareils d'éclairage IP65 LED et T5 Fluorescent High bay,
- Luminaires LED IP65 et T5, T8 Fluorescent Waterproof,
- Luminaires IP65 LED et T5, T8 Fluorescent ExProof,
- Lèche-murs
- Spots encastrés, éclairages sur rail,
- Lampes Glop,
- Capteur de mouvement,
- Lampes à détecteur de mouvement,

Nos atouts:

Le catalogue de PAMIR montre une large gamme de luminaires, luminaires étanches, hublots avec détecteur de mouvement, hublots, appliques... et accessoires, suspendus et/ou encastrés à fixer au plafond, des appliques et hublots muraux, ... tous fabriqués avec des matières premières de qualité et une expertise hors pair.

Grace à l'existence au sein de la société des différentes étapes de conception et de fabrication, nous sommes en mesure de penser des produits qui allient aussi bien l'esthétique, la qualité, mais également la compétitivité.

Tous les produits sont conçus dans notre département R&D, avec l'utilisation des logiciels CAD/CAM et autres, les moules réalisés dans notre propre atelier de moulage, puis une fois testés et approuvés, fabriqués.

Chaque commande – petite ou grande – bénéficie de notre attention jusqu'au moindre détail.

Quels que soient vos besoins en éclairage, laissez nous le soin de les prendre en charge. Nous sommes dans le domaine depuis près de 40 ans, et les commandes répétées de nos fidèles clients, tant en Turquie qu'à l'Étranger, sont la meilleure preuve de notre qualité et sérieuse.

Nous serons très honorés de vous connaître et de vous servir.

GALAKSI
PL8

SF-08
PAGE



ELITE
PL10

SF-62
PAGE



PRIZMA
PL4

SF-78
PAGE

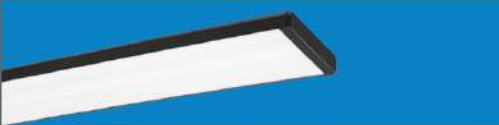

FAST LINE
PL23

SF-86
PAGE



VEGA
PL7

SF-92
PAGE



OPTIMUM
PL17 - PL18A

SF-108
PAGE



VEGA SLIM
PL13

SF-116
PAGE



SIMETRI
PL6

SF-130
PAGE



SIMETRI SLIM
PL21

SF-136
PAGE



FLEKSI
PL3

SF-144
PAGE

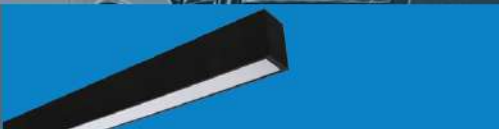

ELEGANT
PL1

SF-150
PAGE



APPLIQUE
PL5 - PL9

SF-158
PAGE



COVE LIGHTING
PL20

SF-164
PAGE

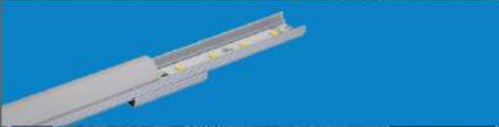

QUADRO
PL19

SF-168
PAGE



SURFACE MOUNTED
PL11U

SF-172
PAGE



STERILE
PL12

SF-176
PAGE



RECESSED BACK-LIGHT
PL11A - PL11EA

SF-182
PAGE



CLIP-IN BACK-LIGHT
PL11C

SF-190
PAGE

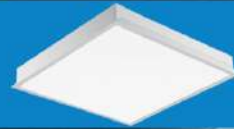

TRIM LINE
PL13A

SF-194
PAGE



ASYMMETRIC
PL15

SF-198
PAGE



V-LINE RECESSED
PL24A

SF-204
PAGE



SLIM LINE
PL14A

SF-208
PAGE



PROLINE
PL2

SF-212
PAGE



WALLWASHER
EALW

SF-218
PAGE



RADIANT
EAL

SF-222
PAGE



INDUSTRIAL / INDUSTRIEL
EAL

SF-228
PAGE



WATERPROOF & EX-PRROF
EAL - EAXL

SF-234
PAGE



TRACK LIGHT
PLR

SF-246
PAGE



DOWNLIGHT
PLC - PLD

SF-256
PAGE



GLOP
GLS - SGS

SF-280
PAGE



SENSOR
SN10 - SN20

SF-290
PAGE





 **pamir**[®]
aydınlatma





GALAKSI

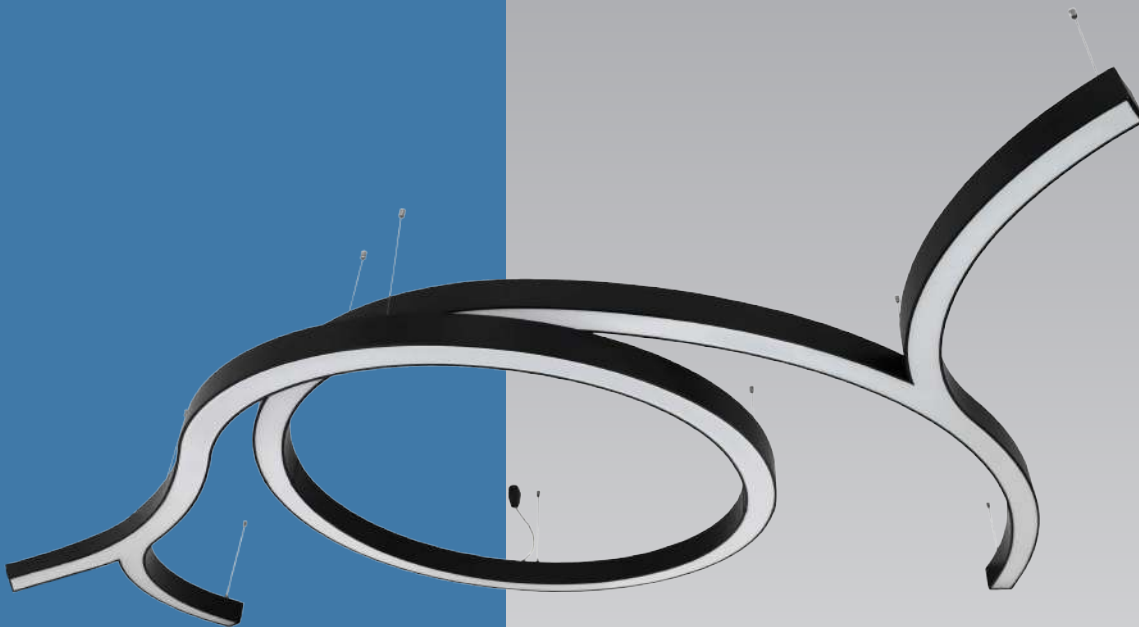

GALAKSI FREEDOM

LED

Suspended Lighting Fixtures With Frosted Diffuser

Luminaire suspendus Avec Diffuseur Givré

APPLICATION AREAS

Shopping Malls
Supermarkets
Offices
Meeting rooms
Stores
Hospitals
Schools
Corridors

DOMAINES D'UTILISATION

Centres Commerciaux
Supermarchés
Bureaux
Salles de Réunions
Magasins
Hopitaux
Ecoles
Couloirs

BODY

Anodized aluminum with satin finishing. Black and white color options with elegant design.

DIFFUSER

UV stabilized frosted diffuser.

CONVERTER

Long life, low power loss converter with constant current. Compatible with ENEC standards.

LED

LED modules with 60.000 hours lifetime LUMILEDS / SAMSUNG / NICHIA brand LEDs.

SUSPENSION

Composed of 1mm steel wire rope and nickel-plated brass components. Suspension height is adjustable. Supplied with transparent electric cord and ceiling mounted electrical junction box with aesthetic design.

CORPS

Corps en aluminium anodisé, satiné. Design élégant. Couleurs blanc, noir disponibles.

DIFFUSEUR

Diffuseur givré. Anti UV.

CONVERTEUR

Convertisseur, conforme aux normes ENEC. Longue vie. Perte de puissance faible avec courant constant.

LED

Modules LED - Durée de vie 60.000 heures avec LED de marque LUMILEDS / SAMSUNG / NICHIA.

SYSTEME DE FIXATION

Composé d'un fil en acier de 1mm, de composants en laiton nickelés. Livré avec un cordon électrique transparent et une boîte de jonction électrique à fixer au plafond. Hauteur de fixation réglable.

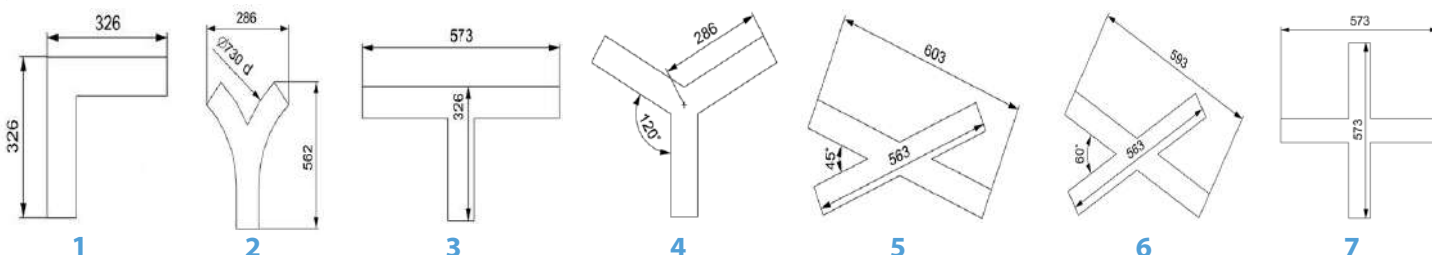

Color Options
Options de Couleur



LED Type / Type LED

Color Rendering Index / Indice de Rendu des Couleurs: (CRI): Ra>80

Code	Power Puissance (W)	LED Type Type De LED	LED Module Module LED	Lum. Flux Flux Lum. (lm)	Color Temperature Température De Couleur (K)	Dimensions (mm)			Weight Poids (kg)	Shape La Forme
						a	d	h		
PL8S180F3L15C	21	2835 SMD	PCB	2055	2700 - 6500	79	620	89	1,9	
PL8S180F4L15C	26	2835 SMD	PCB	2740	2700 - 6500	79	800	89	2,6	
PL8S180F5L15C	33	2835 SMD	PCB	3420	2700 - 6500	79	980	89	3,3	
PL8S180F6L15C	39	2835 SMD	PCB	4105	2700 - 6500	79	1155	89	3,9	
PL8S180F7L15C	47	2835 SMD	PCB	4790	2700 - 6500	79	1335	89	4,5	
PL8S180F8L15C	53	2835 SMD	PCB	5475	2700 - 6500	79	1500	89	5,1	
PL8S180F10L15C	66	2835 SMD	PCB	6840	2700 - 6500	79	1890	89	5,9	
PL8S180F12L15C	79	2835 SMD	PCB	8210	2700 - 6500	79	2255	89	6,7	
PL8S180F14L15C	92	2835 SMD	PCB	9580	2700 - 6500	79	2610	89	7,7	
PL8S180F16L15C	105	2835 SMD	PCB	10945	2700 - 6500	79	2950	89	8,6	
PL8S90F2L15C	14	2835 SMD	PCB	1370	2700 - 6500	79	800	89	1,5	
PL8S90F3L15C	21	2835 SMD	PCB	2055	2700 - 6500	79	1155	89	2,0	
PL8S90F4L15C	26	2835 SMD	PCB	2740	2700 - 6500	79	1500	89	2,6	
PL8S90F5L15C	33	2835 SMD	PCB	3420	2700 - 6500	79	1890	89	3,3	
PL8S90F6L15C	39	2835 SMD	PCB	4105	2700 - 6500	79	2255	89	3,9	
PL8S90F7L15C	47	2835 SMD	PCB	4790	2700 - 6500	79	2610	89	4,5	
PL8S90F8L15C	53	2835 SMD	PCB	5475	2700 - 6500	79	2950	89	5,1	
PL8S90F9L15C	60	2835 SMD	PCB	6160	2700 - 6500	79	3315	89	5,5	
PL8S90F10L15C	66	2835 SMD	PCB	6840	2700 - 6500	79	3675	89	5,9	
PL8S45F1L15C	8	2835 SMD	PCB	685	2700 - 6500	79	800	89	1,5	
PL8S45F2L15C	14	2835 SMD	PCB	1370	2700 - 6500	79	1500	89	1,5	
PL8S45F3L15C	21	2835 SMD	PCB	2055	2700 - 6500	79	2255	89	2,0	
PL8S45F4L15C	26	2835 SMD	PCB	2740	2700 - 6500	79	2950	89	2,6	
PL8S45F5L15C	33	2835 SMD	PCB	3420	2700 - 6500	79	3675	89	3,3	
PL8SLF1L15C	8	2835 SMD	PCB	685	2700 - 6500	79	282	89	1,5	
PL8SLF2L15C	14	2835 SMD	PCB	1370	2700 - 6500	79	565	89	1,5	
PL8SLF3L15C	21	2835 SMD	PCB	2055	2700 - 6500	79	845	89	2,0	
PL8SLF4L15C	26	2835 SMD	PCB	2740	2700 - 6500	79	1125	89	2,6	
PL8SLF5L15C	33	2835 SMD	PCB	3420	2700 - 6500	79	1405	89	3,3	
PL8SLF6L15C	39	2835 SMD	PCB	4105	2700 - 6500	79	1685	89	3,9	
PL8SLF7L15C	47	2835 SMD	PCB	4790	2700 - 6500	79	1965	89	4,5	
PL8SLF8L15C	53	2835 SMD	PCB	5475	2700 - 6500	79	2254	89	5,1	
PL8SLF9L15C	60	2835 SMD	PCB	6160	2700 - 6500	79	2525	89	5,5	
PL8SLF10L15C	66	2835 SMD	PCB	6840	2700 - 6500	79	2810	89	5,9	
Code	Power Puissance (W)	LED Type Type De LED	LED Module Module LED	Lum. Flux Flux Lum. (lm)	Color Temperature Température De	Dimensions (mm)		Weight Poids (kg)	Shape La Forme	
						a	h			
PL8SCF2L15C	14	2835 SMD	PCB	1370	2700 - 6500	79	89	1,5	1	
PL8SAF3L15C	21	2835 SMD	PCB	2055	2700 - 6500	79	89	2,0	2	
PL8STF3L15C	21	2835 SMD	PCB	2055	2700 - 6500	79	89	2,0	3	
PL8SYF3L15C	21	2835 SMD	PCB	2055	2700 - 6500	79	89	2,0	4	
PL8S45KF4L15C	26	2835 SMD	PCB	2740	2700 - 6500	79	89	2,6	5	
PL8S60KF4L15C	26	2835 SMD	PCB	2740	2700 - 6500	79	89	2,6	6	
PL8S90KF4L15C	26	2835 SMD	PCB	2740	2700 - 6500	79	89	2,6	7	



GALAKSI O DIRECT / INDIRECT

LED

Suspended Lighting Fixtures With Frosted Diffuser

Luminaire Suspendus Avec Diffuseur Givré

APPLICATION AREAS

Shopping Malls
Supermarkets
Offices
Meeting rooms
Stores
Hospitals
Schools
Corridors

DOMAINES D'UTILISATION

Centres Commerciaux
Supermarchés
Bureaux
Salles de Réunions
Magasins
Hopitaux
Ecoles
Couloirs

BODY

Anodized aluminum with satin finishing. Black and white color options with elegant design.

DIFFUSER

UV stabilized frosted diffuser.

CONVERTER

Long life, low power loss converter with constant current. Compatible with ENEC standards.

LED

LED modules with 60.000 hours lifetime LUMILEDS / SAMSUNG / NICHIA brand LEDs.

SUSPENSION

Composed of 1mm steel wire rope and nickel-plated brass components. Suspension height is adjustable. Supplied with transparent electric cord and ceiling mounted electrical junction box with aesthetic design.

CORPS

Corps en aluminium anodisé, satiné. Design élégant. Couleurs blanc, noir disponibles.

DIFFUSEUR

Diffuseur givré. Anti UV.

CONVERTEUR

Convertisseur, conforme aux normes ENEC. Longue vie. Perte de puissance faible avec courant constant.

LED

Modules LED – Durée de vie 60.000 heures avec LED de marque LUMILEDS / SAMSUNG / NICHIA.

SYSTEME DE FIXATION

Composé d'un fil en acier de 1mm, de composants en laiton nickelés. Livré avec un cordon électrique transparent et une boîte de jonction électrique à fixer au plafond. Hauteur de fixation réglable.

Indirect Lighting
Éclairage Indirect

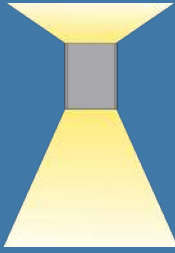

Direct Lighting
Éclairage Direct

Color Options
Options de Couleur



LED Type / Type LED

Color Rendering Index / Indice de Rendu des Couleurs: (CRI): Ra>80

Kod Code	Power Puissance (W)	LED Type Type De LED	LED Module Module LED	Lum. Flux Flux Lum. (lm)	Color Temperature Température De Couleur (K)	Dimensions (mm)			Weight Poids (kg)	Packing Quantity Colisage	Pcs./20" Container Pcs./20" Conteneur
						a	d	h			
PL8ES06L15C	39/18	2835 SMD	PCB/15	3880/1950	2700 - 6500	79	620	73	3,9	1	550
PL8ES08L15C	53/21	2835 SMD	PCB/18	5170/2340	2700 - 6500	79	800	73	5,1	1	340
PL8ES010L15C	66/28	2835 SMD	PCB/24	6460/3120	2700 - 6500	79	980	73	6,5	1	230
PL8ES012L15C	79/35	2835 SMD	PCB/30	8210/3900	2700 - 6500	79	1155	73	7,7	1	165
PL8ES014L15C	92/38	2835 SMD	PCB/33	9580/4290	2700 - 6500	79	1335	73	8,9	1	125
PL8ES016L15C	105/45	2835 SMD	PCB/39	10945/5070	2700 - 6500	79	1500	73	10,1	1	100
PL8ES020L15C	132/55	2835 SMD	PCB/48	13680/6240	2700 - 6500	79	1890	73	11,3	1	63



In-Direct Side LED Type / Type de LED Côté Indirecte

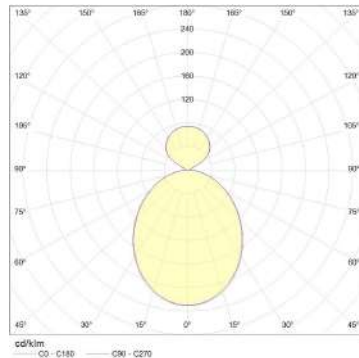
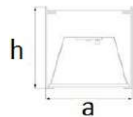
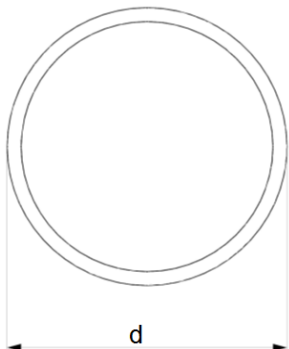

V / Hz 220 - 240 / 50 - 60

Options	Options
Dimmable electronic ballast or convertor. Emergency kit	Ballast électronique dimmable ou converteur. Kit d'urgence.
NOTE	NOTE
Given lumen values are net delivered luminaire output lumens.	Les valeurs de lumens données sont les lumens de sortie nets du luminaire.
Given power values are total consumed AC power of the luminaire.	Les valeurs de puissance données sont la puissance AC totale consommée du luminaire.



GALAKSI O DIRECT

LED

Suspended Lighting Fixtures With Frosted Diffuser

Luminaire Suspendus Avec Diffuseur Givré

APPLICATION AREAS

Shopping Malls
Supermarkets
Offices
Meeting rooms
Stores
Hospitals
Schools
Corridors

DOMAINES D'UTILISATION

Centres Commerciaux
Supermarchés
Bureaux
Salles de Réunions
Magasins
Hopitaux
Ecoles
Couloirs

BODY

Anodized aluminum with satin finishing. Black and white color options with elegant design.

DIFFUSER

UV stabilized frosted diffuser.

CONVERTER

Long life, low power loss converter with constant current. Compatible with ENEC standards.

LED

LED modules with 60.000 hours lifetime LUMILEDS / SAMSUNG / NICHIA brand LEDs.

SUSPENSION

Composed of 1mm steel wire rope and nickel-plated brass components. Suspension height is adjustable. Supplied with transparent electric cord and ceiling mounted electrical junction box with aesthetic design

CORPS

Corps en aluminium anodisé, satiné. Design élégant. Couleurs blanc, noir disponibles.

DIFFUSEUR

Diffuseur givré. Anti UV.

CONVERTEUR

Convertisseur, conforme aux normes ENEC. Longue vie. Perte de puissance faible avec courant constant.

LED

Modules LED – Durée de vie 60.000 heures avec LED de marque LUMILEDS / SAMSUNG / NICHIA.

SYSTEME DE FIXATION

Composé d'un fil en acier de 1mm, de composants en laiton nickelés. Livré avec un cordon électrique transparent et une boîte de jonction électrique à fixer au plafond. Hauteur de fixation réglable.

Color Options
Options de Couleur



LED Type / Type LED

Color Rendering Index / Indice de Rendu des Couleurs: (CRI): Ra>80

Kod Code	Power Puissance (W)	LED Type Type De LED	LED Module Module LED	Lum. Flux Flux Lum. (lm)	Color Temperature Température De Couleur (K)	Dimensions (mm)			Weight Poids (kg)	Packing Quantity Colisage	Pcs./20" Container Pcs./20" Conteneur
						a	d	h			
PL8S04L15C	26	2835 SMD	PCB	2585	2700 - 6500	79	447	73	5,1	1	910
PL8S06L15C	39	2835 SMD	PCB	3880	2700 - 6500	79	620	73	6,0	1	550
PL8S06L25C	61	2835 SMD	PCB	5835	2700 - 6500	79	620	73	6,0	1	550
PL8S08L15C	53	2835 SMD	PCB	5170	2700 - 6500	79	800	73	7,7	1	340
PL8S08L25C	80	2835 SMD	PCB	7780	2700 - 6500	79	800	73	7,7	1	340
PL8S010L15C	66	2835 SMD	PCB	6460	2700 - 6500	79	980	73	10,7	1	230
PL8S010L25C	100	2835 SMD	PCB	9725	2700 - 6500	79	980	73	10,7	1	230
PL8S012L15C	79	2835 SMD	PCB	8210	2700 - 6500	79	1155	73	12,7	1	165
PL8S012L25C	120	2835 SMD	PCB	12315	2700 - 6500	79	1155	73	12,7	1	165
PL8S014L15C	92	2835 SMD	PCB	9580	2700 - 6500	79	1335	73	14,7	1	125
PL8S014L25C	140	2835 SMD	PCB	14370	2700 - 6500	79	1335	73	14,7	1	125
PL8S016L15C	105	2835 SMD	PCB	10945	2700 - 6500	79	1500	73	17,7	1	100
PL8S016L25C	160	2835 SMD	PCB	16420	2700 - 6500	79	1500	73	17,7	1	100
PL8S020L15C	132	2835 SMD	PCB	13680	2700 - 6500	79	1890	73	18,7	1	63
PL8S020L25C	200	2835 SMD	PCB	20520	2700 - 6500	79	1890	73	18,7	1	63
PL8S022L15C	145	2835 SMD	PCB	15050	2700 - 6500	79	2070	73	19,2	1	55
PL8S022L25C	221	2835 SMD	PCB	22575	2700 - 6500	79	2070	73	19,2	1	55
PL8S024L15C	158	2835 SMD	PCB	16420	2700 - 6500	79	2254	73	19,7	1	62
PL8S024L25C	240	2835 SMD	PCB	24630	2700 - 6500	79	2254	73	19,7	1	62

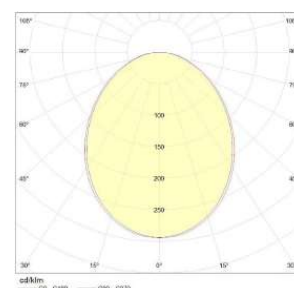
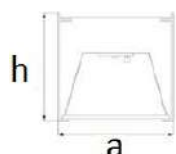
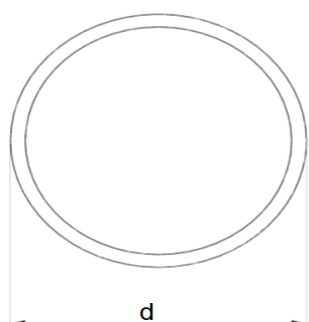



GALAKSI O SLIM DIRECT

LED

Suspended Lighting Fixtures With Frosted Diffuser

Luminaire Suspendus Avec Diffuseur Givré

APPLICATION AREAS

Shopping Malls
Supermarkets
Offices
Meeting rooms
Stores
Hospitals
Schools
Corridors

DOMAINES D'UTILISATION

Centres Commerciaux
Supermarchés
Bureaux
Salles de Réunions
Magasins
Hopitaux
Ecoles
Couloirs

BODY

Anodized aluminum with satin finishing. Black and white color options with elegant design.

DIFFUSER

UV stabilized frosted diffuser.

CONVERTER

Long life, low power loss converter with constant current. Compatible with ENEC standards.

LED

LED modules with 60.000 hours lifetime LUMILEDS / SAMSUNG / NICHIA brand LEDs.

SUSPENSION

Composed of 1mm steel wire rope and nickel-plated brass components. Suspension height is adjustable. Supplied with transparent electric cord and ceiling mounted electrical junction box with aesthetic design

CORPS

Corps en aluminium anodisé, satiné. Design élégant. Couleurs blanc, noir disponibles.

DIFFUSEUR

Diffuseur givré. Anti UV.

CONVERTEUR

Convertisseur, conforme aux normes ENEC. Longue vie. Perte de puissance faible avec courant constant.

LED

Modules LED – Durée de vie 60.000 heures avec LED de marque LUMILEDS / SAMSUNG / NICHIA.

SYSTEME DE FIXATION

Composé d'un fil en acier de 1mm, de composants en laiton nickelés. Livré avec un cordon électrique transparent et une boîte de jonction électrique à fixer au plafond. Hauteur de fixation réglable.

Color Options
Options de Couleur



LED Type / Type LED

Color Rendering Index / Indice de Rendu des Couleurs: (CRI): Ra>80

Kod Code	Power Puissance (W)	LED Type Type De LED	LED Module Module LED	Lum. Flux Flux Lum. (lm)	Color Temperature Température De Couleur (K)	Dimensions (mm)			Weight Poids (kg)	Packing Quantity Colisage	Pcs./20" Container Pcs./20" Conteneur	Rozans Type Type de Rozans
						a	d	h				
PL8S0S4L15C	26	2835 SMD	PCB	2390	2700 - 6500	65	433	73	4,8	1	910	
PL8S0S6L15C	39	2835 SMD	PCB	3590	2700 - 6500	65	606	73	5,8	1	550	
PL8S0S6L25C	61	2835 SMD	PCB	5385	2700 - 6500	65	606	73	5,8	1	550	
PL8S0S8L15C	53	2835 SMD	PCB	4790	2700 - 6500	65	786	73	7,5	1	340	
PL8S0S8L25C	80	2835 SMD	PCB	7180	2700 - 6500	65	786	73	7,5	1	340	
PL8S0S10L15C	66	2835 SMD	PCB	5985	2700 - 6500	65	966	73	10,5	1	230	
PL8S0S10L25C	100	2835 SMD	PCB	8977	2700 - 6500	65	966	73	10,5	1	230	
PL8S0S12L15C	79	2835 SMD	PCB	7980	2700 - 6500	65	1142	73	12,5	1	165	
PL8S0S12L25C	120	2835 SMD	PCB	11970	2700 - 6500	65	1142	73	12,5	1	165	
PL8S0S14L15C	92	2835 SMD	PCB	9310	2700 - 6500	65	1322	73	14,5	1	125	
PL8S0S14L25C	140	2835 SMD	PCB	13965	2700 - 6500	65	1322	73	14,5	1	125	
PL8S0S16L15C	105	2835 SMD	PCB	10640	2700 - 6500	65	1486	73	17,5	1	100	
PL8S0S16L25C	160	2835 SMD	PCB	15960	2700 - 6500	65	1486	73	17,5	1	100	
PL8S0S20L15C	132	2835 SMD	PCB	13300	2700 - 6500	65	1876	73	18,5	1	63	
PL8S0S20L25C	200	2835 SMD	PCB	19950	2700 - 6500	65	1876	73	18,5	1	63	
PL8S0S22L15C	145	2835 SMD	PCB	14630	2700 - 6500	65	2056	73	19,0	1	55	
PL8S0S22L25C	221	2835 SMD	PCB	21945	2700 - 6500	65	2056	73	19,0	1	55	
PL8S0S24L15C	158	2835 SMD	PCB	15960	2700 - 6500	65	2240	73	19,5	1	62	
PL8S0S24L25C	240	2835 SMD	PCB	23940	2700 - 6500	65	2240	73	19,5	1	62	

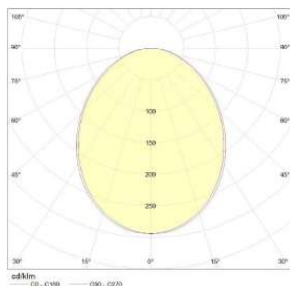
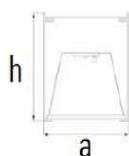
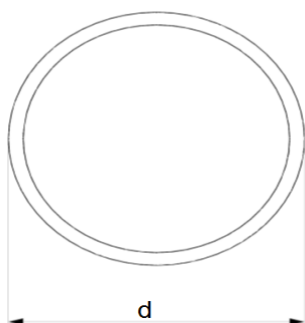

V / Hz 220 - 240 / 50 - 60

NOTE	NOTE
Given lumen values are net delivered luminaire output lumens.	Les valeurs de lumens données sont les lumens de sortie nets du luminaire.
Given power values are total consumed AC power of the luminaire.	Les valeurs de puissance données sont la puissance AC totale consommée du luminaire.



GALAKSI O VISION

LED

Suspended Lighting Fixtures With Special Lens

Luminaires Suspendus Avec Lentille Spéciale

APPLICATION AREAS

Shopping Malls
Supermarkets
Offices
Meeting rooms
Stores
Hospitals
Schools
Corridors

DOMAINES D'UTILISATION

Centres Commerciaux
Supermarchés
Bureaux
Salles de Réunions
Magasins
Hopitaux
Ecoles
Couloirs

BODY

Anodized aluminum with satin finishing. Black and white color options with elegant design.

LENS

Special lens for focused light distribution.

CONVERTER

Long life, low power loss converter with constant current. Compatible with ENEC standards.

LED

LED modules with 60.000 hours lifetime LUMILEDS / SAMSUNG / NICHIA brand LEDs.

SUSPENSION

Composed of 1mm steel wire rope and nickel-plated brass components. Suspension height is adjustable. Supplied with transparent electric cord and ceiling mounted electrical junction box with aesthetic design

CORPS

Corps en aluminium anodisé, satiné. Design élégant. Couleurs blanc, noir disponibles.

LENTILLE

Lentille spéciale pour une distribution lumineuse focalisée.

CONVERTEUR

Convertisseur, conforme aux normes ENEC. Longue vie. Perte de puissance faible avec courant constant.

LED

Modules LED – Durée de vie 60.000 heures avec LED de marque LUMILEDS / SAMSUNG / NICHIA.

SYSTEME DE FIXATION

Composé d'un fil en acier de 1mm, de composants en laiton nickelés. Livré avec un cordon électrique transparent et une boîte de jonction électrique à fixer au plafond. Hauteur de fixation réglable.

NOTE	NOTE
Given lumen values are net delivered luminaire output lumens.	Les valeurs de lumens données sont les lumens de sortie nets du luminaire.
Given power values are total consumed AC power of the luminaire.	Les valeurs de puissance données sont la puissance AC totale consommée du luminaire.

V / Hz 220 - 240 / 50 - 60

Options	Options
Dimmable electronic ballast or convertor.	Ballast électronique dimmable ou convertor.
Emergency kit	Kit d'urgence.

Color Options
Options de Couleur



LED Type / Type LED

Color Rendering Index / Indice de Rendu des Couleurs: (CRI): Ra>80

Kod Code	Power Puissance (W)	LED Type Type De LED	LED Module Module LED	Lum. Flux Flux Lum. (lm)	Color Temperature Température De Couleur (K)	Dimensions (mm)			Weight Poids (kg)	Packing Quantity Colisage	Pcs./20" Container Pcs./20" Conteneur	Lens Quantity Quantité de Lentilles
						a	d	h				
PL8SOV4L15C	10	2835 SMD	PCB	1040	2700 - 6500	79	447	73	5,1	1	910	8
PL8SOV4L25C	14	2835 SMD	PCB	1560	2700 - 6500	79	447	73	5,1	1	910	12
PL8SOV6L15C	14	2835 SMD	PCB	1560	2700 - 6500	79	620	73	6,0	1	550	12
PL8SOV6L25C	21	2835 SMD	PCB	2340	2700 - 6500	79	620	73	6,0	1	550	18
PL8SOV8L15C	19	2835 SMD	PCB	2080	2700 - 6500	79	800	73	7,7	1	340	16
PL8SOV8L25C	28	2835 SMD	PCB	3120	2700 - 6500	79	800	73	7,7	1	340	24
PL8SOV10L15C	23	2835 SMD	PCB	2600	2700 - 6500	79	980	73	10,7	1	230	20
PL8SOV10L25C	35	2835 SMD	PCB	3900	2700 - 6500	79	980	73	10,7	1	230	30
PL8SOV12L15C	28	2835 SMD	PCB	3120	2700 - 6500	79	1155	73	12,7	1	165	24
PL8SOV12L25C	42	2835 SMD	PCB	4680	2700 - 6500	79	1155	73	12,7	1	165	36
PL8SOV14L15C	32	2835 SMD	PCB	3640	2700 - 6500	79	1335	73	14,7	1	125	28
PL8SOV14L25C	49	2835 SMD	PCB	5460	2700 - 6500	79	1335	73	14,7	1	125	42
PL8SOV16L15C	37	2835 SMD	PCB	4160	2700 - 6500	79	1500	73	17,7	1	100	32
PL8SOV16L25C	55	2835 SMD	PCB	6240	2700 - 6500	79	1500	73	17,7	1	100	48
PL8SOV20L15C	46	2835 SMD	PCB	5200	2700 - 6500	79	1890	73	18,7	1	63	40
PL8SOV20L25C	69	2835 SMD	PCB	7800	2700 - 6500	79	1890	73	18,7	1	63	60
PL8SOV22L15C	51	2835 SMD	PCB	5720	2700 - 6500	79	2070	73	19,2	1	55	44
PL8SOV22L25C	76	2835 SMD	PCB	8580	2700 - 6500	79	2070	73	19,2	1	55	66
PL8SOV24L15C	55	2835 SMD	PCB	6240	2700 - 6500	79	2254	73	19,7	1	62	48
PL8SOV24L25C	83	2835 SMD	PCB	9360	2700 - 6500	79	2254	73	19,7	1	62	72

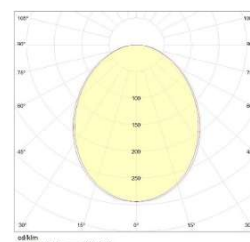
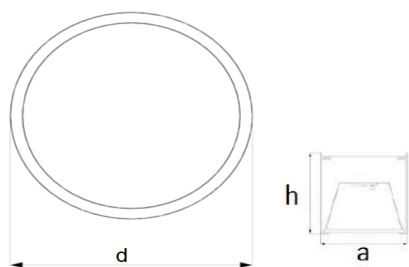



GALAKSI O TEXTILE ACOUSTIC

LED

Suspended Lighting Fixtures With Frosted Diffuser & Special Textile

Luminaire Suspendus Avec Diffuseur Givré et Textile Spéciale

BODY

Anodized aluminum with satin finishing. Black and white color options with elegant design.

TEXTILE

Natural textile that absorbs excess noise in the environment.

DIFFUSER

UV stabilized frosted diffuser.

CONVERTER

Long life, low power loss converter with constant current. Compatible with ENEC standards.

LED

LED modules with 60.000 hours lifetime LUMILEDS / SAMSUNG / NICHIA brand LEDs.

SUSPENSION

Composed of 1mm steel wire rope and nickel-plated brass components. Suspension height is adjustable. Supplied with transparent electric cord and ceiling mounted electrical junction box with aesthetic design

CORPS

Corps en aluminium anodisé, satiné. Design élégant. Couleurs blanc, noir disponibles.

TEXTILE

Textile naturel qui absorbe l'excès de bruit dans l'environnement.

DIFFUSEUR

Diffuseur givré. Anti UV.

CONVERTEUR

Convertisseur, conforme aux normes ENEC. Longue vie. Perte de puissance faible avec courant constant.

LED

Modules LED – Durée de vie 60.000 heures avec LED de marque LUMILEDS / SAMSUNG / NICHIA.

SYSTEME DE FIXATION

Composé d'un fil en acier de 1mm, de composants en laiton nickelés. Livré avec un cordon électrique transparent et une boîte de jonction électrique à fixer au plafond. Hauteur de fixation réglable.

APPLICATION AREAS

Shopping Malls
Supermarkets
Offices
Meeting rooms
Stores
Hospitals
Schools

DOMAINES D'UTILISATION

Centres Commerciaux
Supermarchés
Bureaux
Salles de Réunions
Magasins
Hopitaux
Ecoles

V / Hz 220 - 240 / 50 - 60

Options	Options
Dimmable electronic ballast or convertor.	Ballast électronique dimmable ou converteur.
Emergency kit	Kit d'urgence.

NOTE	NOTE
Given lumen values are net delivered luminaire output lumens.	Les valeurs de lumens données sont les lumens de sortie nets du luminaire.
Given power values are total consumed AC power of the luminaire.	Les valeurs de puissance données sont la puissance AC totale consommée du luminaire.

Color Options
Options de Couleur



LED Type / Type LED

Color Rendering Index / Indice de Rendu des Couleurs: (CRI): Ra>80

Kod Code	Power Puissance (W)	LED Type Type De LED	LED Module Module LED	Lum. Flux Flux Lum. (lm)	Color Temperature Température De Couleur (K)	Dimensions (mm)			Weight Poids (kg)	Packing Quantity Colisage	Pcs./20" Container Pcs./20" Conteneur
						a	d	h			
PL8SATO4L15C	26	2835 SMD	PCB	2585	2700 - 6500	79	447	73	5,1	1	910
PL8SATO6L15C	39	2835 SMD	PCB	3880	2700 - 6500	79	620	73	6,0	1	550
PL8SATO6L25C	61	2835 SMD	PCB	5835	2700 - 6500	79	620	73	6,0	1	550
PL8SATO8L15C	53	2835 SMD	PCB	5170	2700 - 6500	79	800	73	7,7	1	340
PL8SATO8L25C	80	2835 SMD	PCB	7780	2700 - 6500	79	800	73	7,7	1	340
PL8SATO10L15C	66	2835 SMD	PCB	6460	2700 - 6500	79	980	73	10,7	1	230
PL8SATO10L25C	100	2835 SMD	PCB	9725	2700 - 6500	79	980	73	10,7	1	230
PL8SATO12L15C	79	2835 SMD	PCB	8210	2700 - 6500	79	1155	73	12,7	1	165
PL8SATO12L25C	120	2835 SMD	PCB	12315	2700 - 6500	79	1155	73	12,7	1	165
PL8SATO14L15C	92	2835 SMD	PCB	9580	2700 - 6500	79	1335	73	14,7	1	125
PL8SATO14L25C	140	2835 SMD	PCB	14370	2700 - 6500	79	1335	73	14,7	1	125
PL8SATO16L15C	105	2835 SMD	PCB	10945	2700 - 6500	79	1500	73	17,7	1	100
PL8SATO16L25C	160	2835 SMD	PCB	16420	2700 - 6500	79	1500	73	17,7	1	100
PL8SATO20L15C	132	2835 SMD	PCB	13680	2700 - 6500	79	1890	73	18,7	1	63
PL8SATO20L25C	200	2835 SMD	PCB	20520	2700 - 6500	79	1890	73	19,1	1	63
PL8SATO22L15C	145	2835 SMD	PCB	15050	2700 - 6500	79	2070	73	19,2	1	55
PL8SATO22L25C	221	2835 SMD	PCB	22575	2700 - 6500	79	2070	73	19,2	1	55

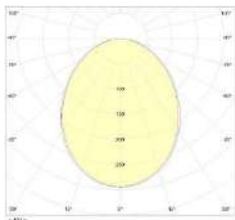
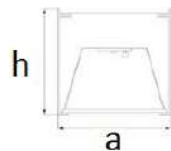
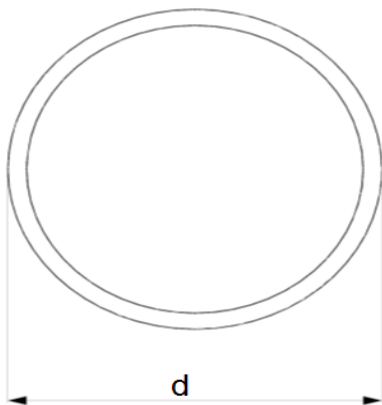

Fabric Color Options / Options de Couleur du Tissu



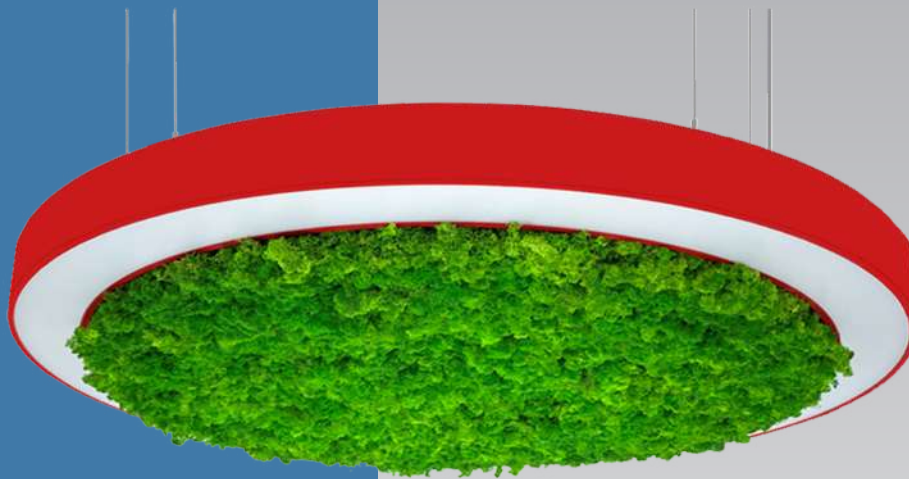

GALAKSI O ACOUSTIC

LED

Suspended Lighting Fixtures With Frosted Diffuser & Special Moss

Luminaire Suspendus Avec Diffuseur Givré et Mousse Spéciale

BODY

Anodized aluminum with satin finishing. Black and white color options with elegant design.

MOSS

Natural moss that absorbs excess noise in the environment.

DIFFUSER

UV stabilized frosted diffuser.

CONVERTER

Long life, low power loss converter with constant current. Compatible with ENEC standards.

LED

LED modules with 60.000 hours lifetime LUMILEDS / SAMSUNG / NICHIA brand LEDs.

SUSPENSION

Composed of 1mm steel wire rope and nickel-plated brass components. Suspension height is adjustable. Supplied with transparent electric cord and ceiling mounted electrical junction box with aesthetic design

APPLICATION AREAS

Shopping Malls
Supermarkets
Offices
Meeting rooms
Stores
Hospitals
Schools

DOMAINES D'UTILISATION

Centres Commerciaux
Supermarchés
Bureaux
Salles de Réunions
Magasins
Hopitaux
Ecoles

CORPS

Corps en aluminium anodisé, satiné. Design élégant. Couleurs blanc, noir disponibles.

MOUSSE

Mousse naturelle qui absorbe l'excès de bruit dans l'environnement.

DIFFUSEUR

Diffuseur givré. Anti UV.

CONVERTEUR

Convertisseur, conforme aux normes ENEC. Longue vie. Perte de puissance faible avec courant constant.

LED

Modules LED – Durée de vie 60.000 heures avec LED de marque LUMILEDS / SAMSUNG / NICHIA.

SYSTEME DE FIXATION

Composé d'un fil en acier de 1mm, de composants en laiton nickelés. Livré avec un cordon électrique transparent et une boîte de jonction électrique à fixer au plafond. Hauteur de fixation réglable.

Color Options
Options de Couleur



LED Type / Type LED

Color Rendering Index / Indice de Rendu des Couleurs: (CRI): Ra>80

Kod Code	Power Puissance (W)	LED Type Type De LED	LED Module Module LED	Lum. Flux Flux Lum. (lm)	Color Temperature Température De Couleur (K)	Dimensions (mm)			Weight Poids (kg)	Packing Quantity Colisage	Pcs./20" Container Pcs./20" Conteneur
						a	d	h			
PL8SA04L15C	26	2835 SMD	PCB	2585	2700 - 6500	79	447	73	5,1	1	910
PL8SA06L15C	39	2835 SMD	PCB	3880	2700 - 6500	79	620	73	6,0	1	550
PL8SA06L25C	61	2835 SMD	PCB	5835	2700 - 6500	79	620	73	6,0	1	550
PL8SA08L15C	53	2835 SMD	PCB	5170	2700 - 6500	79	800	73	7,7	1	340
PL8SA08L25C	80	2835 SMD	PCB	7780	2700 - 6500	79	800	73	7,7	1	340
PL8SA010L15C	66	2835 SMD	PCB	6460	2700 - 6500	79	980	73	10,7	1	230
PL8SA010L25C	100	2835 SMD	PCB	9725	2700 - 6500	79	980	73	10,7	1	230
PL8SA012L15C	79	2835 SMD	PCB	8210	2700 - 6500	79	1155	73	12,7	1	165
PL8SA012L25C	120	2835 SMD	PCB	12315	2700 - 6500	79	1155	73	12,7	1	165
PL8SA014L15C	92	2835 SMD	PCB	9580	2700 - 6500	79	1335	73	14,7	1	125
PL8SA014L25C	140	2835 SMD	PCB	14370	2700 - 6500	79	1335	73	14,7	1	125
PL8SA016L15C	105	2835 SMD	PCB	10945	2700 - 6500	79	1500	73	17,7	1	100
PL8SA016L25C	160	2835 SMD	PCB	16420	2700 - 6500	79	1500	73	17,7	1	100
PL8SA020L15C	132	2835 SMD	PCB	13680	2700 - 6500	79	1890	73	18,7	1	63
PL8SA020L25C	200	2835 SMD	PCB	20520	2700 - 6500	79	1890	73	19,1	1	63
PL8SA022L15C	145	2835 SMD	PCB	15050	2700 - 6500	79	2070	73	19,2	1	55
PL8SA022L25C	221	2835 SMD	PCB	22575	2700 - 6500	79	2070	73	19,2	1	55

V / Hz 220 - 240 / 50 - 60

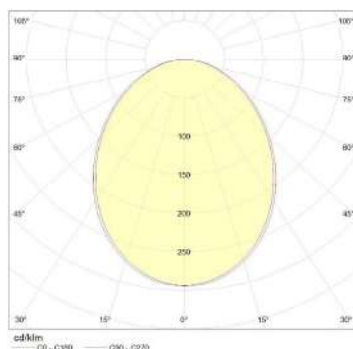
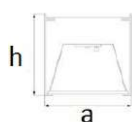
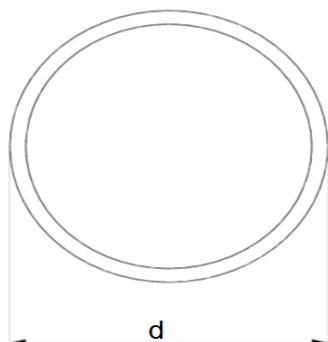

Options

Dimmable electronic ballast or convertor.
Emergency kit

Options

Ballast électronique dimmable ou converteur.
Kit d'urgence.

NOTE

Given lumen values are net delivered luminaire output lumens.

Given power values are total consumed AC power of the luminaire.

NOTE

Les valeurs de lumens données sont les lumens de sortie nets du luminaire.

Les valeurs de puissance données sont la puissance AC totale consommée du luminaire.



GALAKSI S VISION

LED

Suspended Lighting Fixtures With Special Lens

Luminaire suspendu Avec Lentille Spéciale

APPLICATION AREAS

Shopping Malls
Supermarkets
Offices
Meeting rooms
Stores
Hospitals
Schools
Corridors

DOMAINES D'UTILISATION

Centres Commerciaux
Supermarchés
Bureaux
Salles de Réunions
Magasins
Hopitaux
Ecoles
Couloirs

BODY

Anodized aluminum with satin finishing. Black and white color options with elegant design.

LENS

Special lens for focused light distribution.

CONVERTER

Long life, low power loss converter with constant current. Compatible with ENEC standards.

LED

LED modules with 60.000 hours lifetime LUMILEDS / SAMSUNG / NICHIA brand LEDs.

SUSPENSION

Composed of 1mm steel wire rope and nickel-plated brass components. Suspension height is adjustable. Supplied with transparent electric cord and ceiling mounted electrical junction box with aesthetic design

CORPS

Corps en aluminium anodisé, satiné. Design élégant. Couleurs blanc, noir disponibles.

LENTILLE

Lentille spéciale pour une distribution lumineuse focalisée.

CONVERTEUR

Convertisseur, conforme aux normes ENEC. Longue vie. Perte de puissance faible avec courant constant.

LED

Modules LED – Durée de vie 60.000 heures avec LED de marque LUMILEDS / SAMSUNG / NICHIA.

SYSTEME DE FIXATION

Composé d'un fil en acier de 1mm, de composants en laiton nickelés. Livré avec un cordon électrique transparent et une boîte de jonction électrique à fixer au plafond. Hauteur de fixation réglable.

Color Options
Options de Couleur



LED Type / Type LED

Color Rendering Index / Indice de Rendu des Couleurs: (CRI): Ra>80

Code	Power Puissance (W)	LED Type Type De LED	LED Module Module LED	Lum. Flux Flux Lum. (lm)	Color Temperature Température De Couleur (K)	Dimensions (mm)				Weight Poids (kg)	Packing Quantity Colisage	Pcs./20" Container Pcs./20" Conteneur	Drawing No Dessin No	Lens Quantity Quantité de Lentilles
						l	k	a	h					
PL8SSV23L15C	14	2835 SMD	PCB	1560	2700 - 6500	1570	334	79	82	3,9	1	445	1	12
PL8SSV23L25C	21	2835 SMD	PCB	2340	2700 - 6500	1570	334	79	82	3,9	1	445		18
PL8SSV33L15C	21	2835 SMD	PCB	2340	2700 - 6500	2360	395	79	82	5,7	1	233	2	18
PL8SSV33L25C	31	2835 SMD	PCB	3510	2700 - 6500	2360	395	79	82	5,9	1	233		27
PL8SSV24L15C	19	2835 SMD	PCB	2080	2700 - 6500	2070	495	79	82	5,1	1	284	1	16
PL8SSV24L25C	28	2835 SMD	PCB	3120	2700 - 6500	2070	495	79	82	5,3	1	284		24
PL8SSV34L15C	28	2835 SMD	PCB	3120	2700 - 6500	3095	495	79	82	7,7	1	142	2	24
PL8SSV34L25C	42	2835 SMD	PCB	4680	2700 - 6500	3095	495	79	82	7,9	1	142		36
PL8SSV25L15C	23	2835 SMD	PCB	2600	2700 - 6500	2620	610	79	82	6,3	1	137	1	20
PL8SSV25L25C	35	2835 SMD	PCB	3900	2700 - 6500	2620	610	79	82	6,5	1	137		30

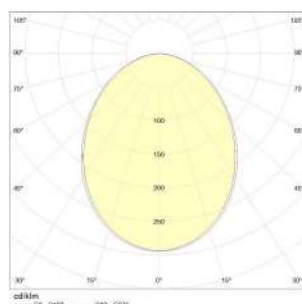
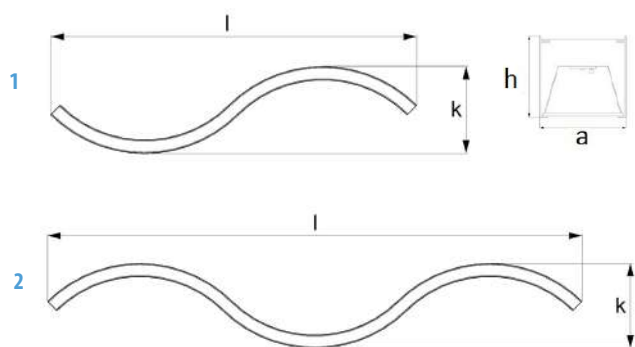

V / Hz 220 - 240 / 50 - 60

Options	Options
Dimmable electronic ballast or convertor. Emergency kit	Ballast électronique dimmable ou converteur. Kit d'urgence.
NOTE	NOTE
Given lumen values are net delivered luminaire output lumens.	Les valeurs de lumens données sont les lumens de sortie nets du luminaire.
Given power values are total consumed AC power of the luminaire.	Les valeurs de puissance données sont la puissance AC totale consommée du luminaire.

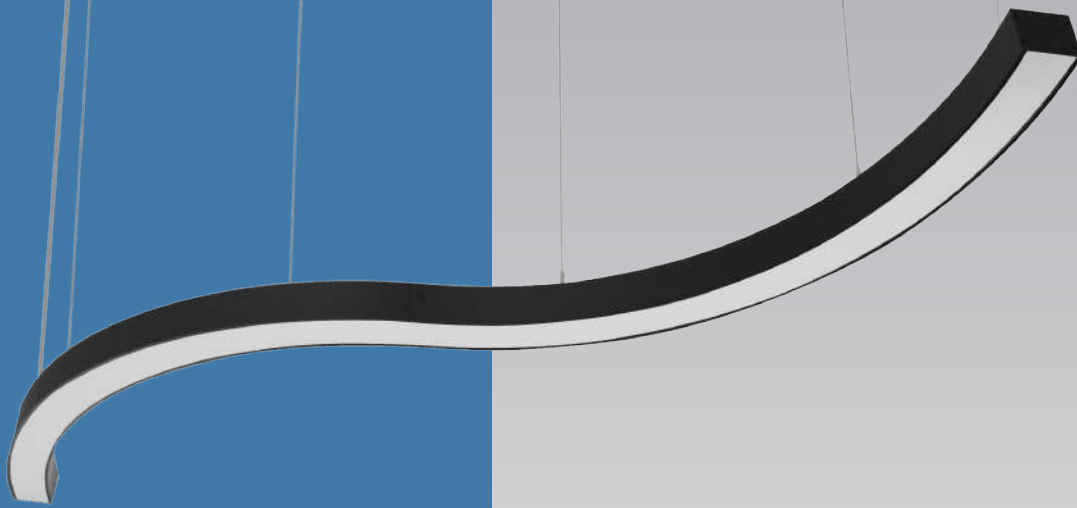

GALAKSI S

LED

Suspended Lighting Fixtures With Frosted Diffuser

Luminaire Suspendus Avec Diffuseur Givré

APPLICATION AREAS

Shopping Malls
Supermarkets
Offices
Meeting rooms
Stores
Hospitals
Schools
Corridors

DOMAINES D'UTILISATION

Centres Commerciaux
Supermarchés
Bureaux
Salles de Réunions
Magasins
Hopitaux
Ecoles
Couloirs

BODY

Anodized aluminum with satin finishing. Black and white color options with elegant design.

DIFFUSER

UV stabilized frosted diffuser.

CONVERTER

Long life, low power loss converter with constant current. Compatible with ENEC standards.

LED

LED modules with 60.000 hours lifetime LUMILEDS / SAMSUNG / NICHIA brand LEDs.

SUSPENSION

Composed of 1mm steel wire rope and nickel-plated brass components. Suspension height is adjustable. Supplied with transparent electric cord and ceiling mounted electrical junction box with aesthetic design

CORPS

Corps en aluminium anodisé, satiné. Design élégant. Couleurs blanc, noir disponibles.

DIFFUSEUR

Diffuseur givré. Anti UV.

CONVERTEUR

Convertisseur, conforme aux normes ENEC. Longue vie. Perte de puissance faible avec courant constant .

LED

Modules LED – Durée de vie 60.000 heures avec LED de marque LUMILEDS / SAMSUNG / NICHIA.

SYSTEME DE FIXATION

Composé d'un fil en acier de 1mm , de composants en laiton nickelés. Livré avec un cordon électrique transparent et une boîte de jonction électrique à fixer au plafond. Hauteur de fixation réglable.

Color Options
Options de Couleur



LED Type / Type LED

Color Rendering Index / Indice de Rendu des Couleurs: (CRI): Ra>80

Code	Power Puissance (W)	LED Type Type De LED	LED Module Module LED	Lum. Flux Flux Lum. (lm)	Color Temperature Température De Couleur (K)	Dimensions (mm)				Weight Poids (kg)	Packing Quantity Colisage	Pcs./20" Container Pcs./20" Conteneur	Drawing No Dessin No
						l	k	a	h				
PL8SS23L15C	39	2835 SMD	PCB	4050	2700 - 6500	1570	334	79	82	3,9	1	445	1
PL8SS23L25C	61	2835 SMD	PCB	6075	2700 - 6500	1570	334	79	82	3,9	1	445	
PL8SS33L15C	60	2835 SMD	PCB	6075	2700 - 6500	2360	395	79	82	5,7	1	233	2
PL8SS33L25C	90	2835 SMD	PCB	9110	2700 - 6500	2360	395	79	82	5,9	1	233	
PL8SS24L15C	53	2835 SMD	PCB	5400	2700 - 6500	2070	495	79	82	5,1	1	284	1
PL8SS24L25C	80	2835 SMD	PCB	8100	2700 - 6500	2070	495	79	82	5,3	1	284	
PL8SS34L15C	79	2835 SMD	PCB	8210	2700 - 6500	3095	495	79	82	7,7	1	142	2
PL8SS34L25C	120	2835 SMD	PCB	12315	2700 - 6500	3095	495	79	82	7,9	1	142	
PL8SS25L15C	66	2835 SMD	PCB	6745	2700 - 6500	2620	610	79	82	6,3	1	137	1
PL8SS25L25C	100	2835 SMD	PCB	10120	2700 - 6500	2620	610	79	82	6,5	1	137	

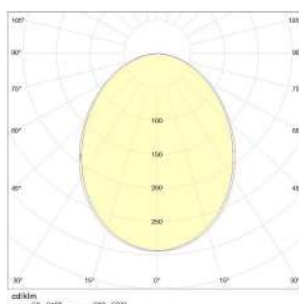
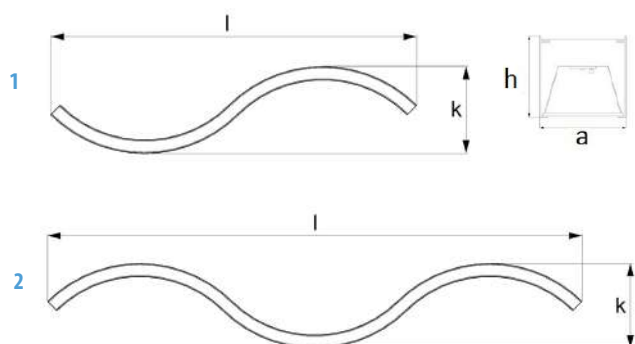

V / Hz 220 - 240 / 50 - 60

Options	Options
Dimmable electronic ballast or convertor. Emergency kit	Ballast électronique dimmable ou converteur. Kit d'urgence.
NOTE	NOTE
Given lumen values are net delivered luminaire output lumens.	Les valeurs de lumens données sont les lumens de sortie nets du luminaire.
Given power values are total consumed AC power of the luminaire.	Les valeurs de puissance données sont la puissance AC totale consommée du luminaire.

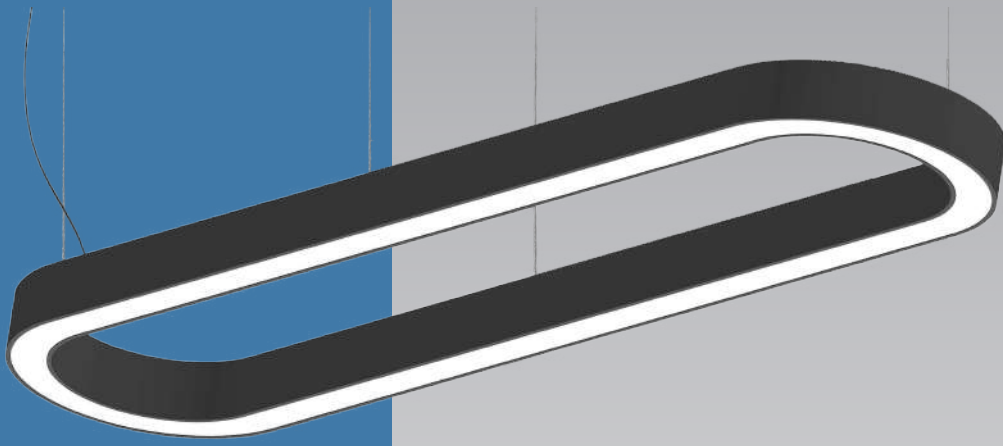

GALAKSI SLIM OVAL

LED

Suspended Lighting Fixtures With Frosted Diffuser

Luminaire suspendus Avec Diffuseur Givré

APPLICATION AREAS

Shopping Malls
Supermarkets
Offices
Meeting rooms
Stores
Hospitals
Schools
Corridors

DOMAINES D'UTILISATION

Centres Commerciaux
Supermarchés
Bureaux
Salles de Réunions
Magasins
Hopitaux
Ecoles
Couloirs

BODY

Anodized aluminum with satin finishing. Black and white color options with elegant design.

DIFFUSER

UV stabilized frosted diffuser.

CONVERTER

Long life, low power loss converter with constant current. Compatible with ENEC standards.

LED

LED modules with 60.000 hours lifetime LUMILEDS / SAMSUNG / NICHIA brand LEDs.

SUSPENSION

Composed of 1mm steel wire rope and nickel-plated brass components. Suspension height is adjustable. Supplied with transparent electric cord and ceiling mounted electrical junction box with aesthetic design

CORPS

Corps en aluminium anodisé, satiné. Design élégant. Couleurs blanc, noir disponibles.

DIFFUSEUR

Diffuseur givré. Anti UV.

CONVERTEUR

Convertisseur, conforme aux normes ENEC. Longue vie. Perte de puissance faible avec courant constant.

LED

Modules LED – Durée de vie 60.000 heures avec LED de marque LUMILEDS / SAMSUNG / NICHIA.

SYSTEME DE FIXATION

Composé d'un fil en acier de 1mm, de composants en laiton nickelés. Livré avec un cordon électrique transparent et une boîte de jonction électrique à fixer au plafond. Hauteur de fixation réglable.

V / Hz 220 - 240 / 50 - 60

Options	Options
Dimmable electronic ballast or convertor.	Ballast électronique dimmable ou converteur.
Emergency kit	Kit d'urgence.

NOTE	NOTE
Given lumen values are net delivered luminaire output lumens.	Les valeurs de lumens données sont les lumens de sortie nets du luminaire.
Given power values are total consumed AC power of the luminaire.	Les valeurs de puissance données sont la puissance AC totale consommée du luminaire.

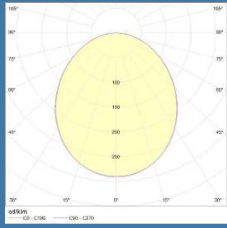

Color Options
Options de Couleur



LED Type / Type LED

Color Rendering Index / Indice de Rendu des Couleurs: (CRI): Ra>80

Kod Code	Power Puissance (W)	LED Type Type De LED	LED Module Module LED	Lum. Flux Flux Lum. (lm)	Color Temperature Température De Couleur (K)	Dimensions (mm)			Weight Poids (kg)	Packing Quantity Colisage	Pcs./20" Container Pcs./20" Conteneur
						a	l	h			
PL8SV4336L15C	39	2835 SMD	PCB	4100	2700 - 6500	433	714	73	7,0	1	570
PL8SV4338L15C	53	2835 SMD	PCB	5470	2700 - 6500	433	995	73	7,7	1	470
PL8SV43310L15C	66	2835 SMD	PCB	6840	2700 - 6500	433	1275	73	10,7	1	370
PL8SV43312L15C	79	2835 SMD	PCB	8210	2700 - 6500	433	1556	73	12,7	1	305
PL8SV43314L15C	92	2835 SMD	PCB	9575	2700 - 6500	433	1837	73	14,7	1	260
PL8SV43316L15C	105	2835 SMD	PCB	10945	2700 - 6500	433	2118	73	17,7	1	225
PL8SV6068L15C	53	2835 SMD	PCB	5470	2700 - 6500	606	887	73	10,1	1	350
PL8SV60610L15C	66	2835 SMD	PCB	6840	2700 - 6500	606	1168	73	10,7	1	300
PL8SV60612L15C	79	2835 SMD	PCB	8210	2700 - 6500	606	1448	73	12,7	1	142
PL8SV60614L15C	92	2835 SMD	PCB	9575	2700 - 6500	606	1729	73	14,7	1	205
PL8SV60616L15C	105	2835 SMD	PCB	10945	2700 - 6500	606	2010	73	17,7	1	180
PL8SV60618L15C	120	2835 SMD	PCB	12310	2700 - 6500	606	2291	73	18,1	1	155
PL8SV78610L15C	66	2835 SMD	PCB	6840	2700 - 6500	786	1067	73	12,1	1	245
PL8SV78612L15C	79	2835 SMD	PCB	8210	2700 - 6500	786	1348	73	12,7	1	205
PL8SV78614L15C	92	2835 SMD	PCB	9575	2700 - 6500	786	1628	73	14,7	1	170
PL8SV78616L15C	105	2835 SMD	PCB	10945	2700 - 6500	786	1909	73	17,7	1	145
PL8SV78618L15C	120	2835 SMD	PCB	12310	2700 - 6500	786	2190	73	18,1	1	125
PL8SV78620L15C	132	2835 SMD	PCB	13680	2700 - 6500	786	2471	73	18,7	1	115
PL8SV96612L15C	79	2835 SMD	PCB	8210	2700 - 6500	966	1247	73	14,7	1	150
PL8SV96614L15C	92	2835 SMD	PCB	9575	2700 - 6500	966	1528	73	14,7	1	150
PL8SV96616L15C	105	2835 SMD	PCB	10945	2700 - 6500	966	1808	73	17,7	1	125
PL8SV96618L15C	120	2835 SMD	PCB	12310	2700 - 6500	966	2089	73	18,1	1	110
PL8SV96620L15C	132	2835 SMD	PCB	13680	2700 - 6500	966	2370	73	18,7	1	95
PL8SV96622L15C	145	2835 SMD	PCB	15050	2700 - 6500	966	2651	73	19,2	1	85

Profile Width is 65mm / La largeur du profilé est de 65 mm

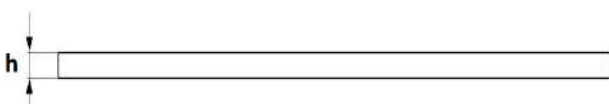

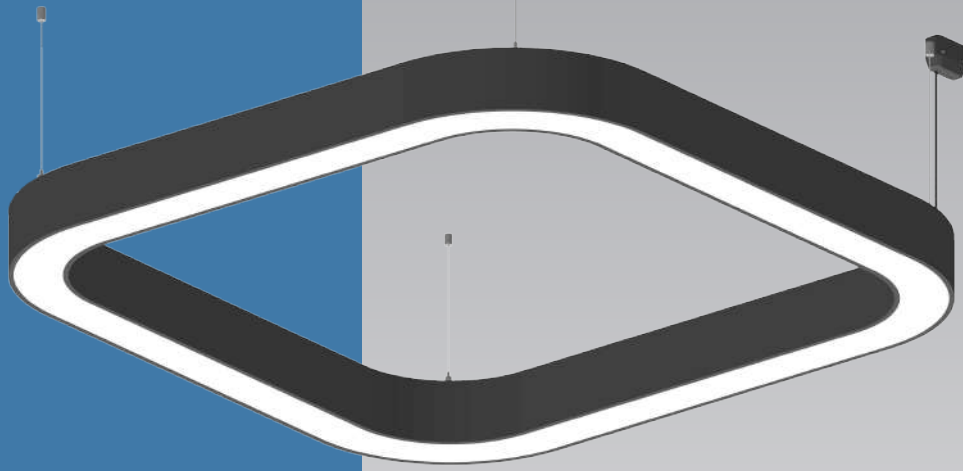

GALAKSI SLIM OVAL KARE

LED

Suspended Lighting Fixtures With Frosted Diffuser

Luminaire suspendus Avec Diffuseur Givré

APPLICATION AREAS

Shopping Malls
Supermarkets
Offices
Meeting rooms
Stores
Hospitals
Schools
Corridors

DOMAINES D'UTILISATION

Centres Commerciaux
Supermarchés
Bureaux
Salles de Réunions
Magasins
Hopitaux
Ecoles
Couloirs

BODY

Anodized aluminum with satin finishing. Black and white color options with elegant design.

DIFFUSER

UV stabilized frosted diffuser.

CONVERTER

Long life, low power loss converter with constant current. Compatible with ENEC standards.

LED

LED modules with 60.000 hours lifetime LUMILEDS / SAMSUNG / NICHIA brand LEDs.

SUSPENSION

Composed of 1mm steel wire rope and nickel-plated brass components. Suspension height is adjustable. Supplied with transparent electric cord and ceiling mounted electrical junction box with aesthetic design

CORPS

Corps en aluminium anodisé, satiné. Design élégant. Couleurs blanc, noir disponibles.

DIFFUSEUR

Diffuseur givré. Anti UV.

CONVERTEUR

Convertisseur, conforme aux normes ENEC. Longue vie. Perte de puissance faible avec courant constant .

LED

Modules LED – Durée de vie 60.000 heures avec LED de marque LUMILEDS / SAMSUNG / NICHIA.

SYSTEME DE FIXATION

Composé d'un fil en acier de 1mm , de composants en laiton nickelés. Livré avec un cordon électrique transparent et une boîte de jonction électrique à fixer au plafond. Hauteur de fixation réglable.

Color Options
Options de Couleur



LED Type / Type LED

Color Rendering Index / Indice de Rendu des Couleurs: (CRI): Ra>80

Kod Code	Power Puissance (W)	LED Type Type De LED	LED Module Module LED	Lum. Flux Flux Lum. (lm)	Color Temperature Température De Couleur (K)	Dimensions (mm)			Weight Poids (kg)	Packing Quantity Colisage	Pcs./20" Container Pcs./20" Conteneur
						a	b	h			
PL8SVK22L15C	106	2835 SMD	PCB/16	10640	2700 - 6500	1350	1350	73	12,7	1	305
PL8SVK23L15C	120	2835 SMD	PCB/18	11970	2700 - 6500	1350	1630	73	12,7	1	305
PL8SVK24L15C	132	2835 SMD	PCB/20	13300	2700 - 6500	1350	1910	73	12,7	1	305
PL8SVK25L15C	145	2835 SMD	PCB/22	14630	2700 - 6500	1350	2190	73	12,7	1	305
PL8SVK26L15C	159	2835 SMD	PCB/24	15960	2700 - 6500	1350	2470	73	12,7	1	305
PL8SVK27L15C	172	2835 SMD	PCB/26	17290	2700 - 6500	1350	2750	73	12,7	1	305
PL8SVK33L15C	132	2835 SMD	PCB/20	13300	2700 - 6500	1630	1630	73	12,7	1	305
PL8SVK34L15C	145	2835 SMD	PCB/22	14630	2700 - 6500	1630	1910	73	12,7	1	305
PL8SVK35L15C	159	2835 SMD	PCB/24	15960	2700 - 6500	1630	2190	73	12,7	1	305
PL8SVK36L15C	172	2835 SMD	PCB/26	17290	2700 - 6500	1630	2470	73	12,7	1	305
PL8SVK37L15C	185	2835 SMD	PCB/28	18620	2700 - 6500	1630	2750	73	12,7	1	305
PL8SVK44L15C	159	2835 SMD	PCB/24	15960	2700 - 6500	1910	1910	73	12,7	1	305
PL8SVK45L15C	172	2835 SMD	PCB/26	17290	2700 - 6500	1910	2190	73	12,7	1	305
PL8SVK46L15C	185	2835 SMD	PCB/28	18620	2700 - 6500	1910	2470	73	12,7	1	305
PL8SVK47L15C	199	2835 SMD	PCB/30	19950	2700 - 6500	1910	2750	73	12,7	1	305
PL8SVK55L15C	185	2835 SMD	PCB/28	18620	2700 - 6500	2190	2190	73	12,7	1	305
PL8SVK56L15C	199	2835 SMD	PCB/30	19950	2700 - 6500	2190	2470	73	12,7	1	305
PL8SVK57L15C	212	2835 SMD	PCB/32	21280	2700 - 6500	2190	2750	73	12,7	1	305

Profile Width is 65mm / La largeur du profilé est de 65 mm

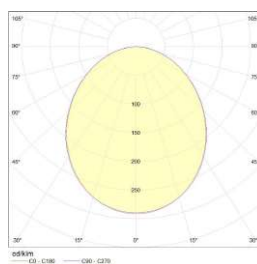
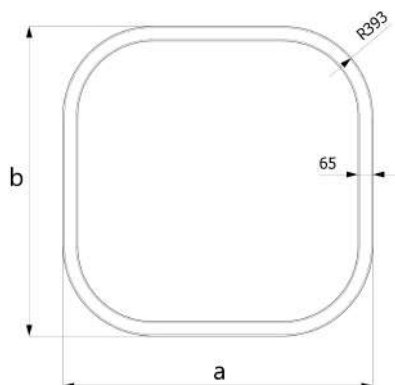

V / Hz 220 - 240 / 50 - 60

Options	Options
Dimmable electronic ballast or convertor. Emergency kit	Ballast électronique dimmable ou convertor. Kit d'urgence.
NOTE	NOTE
Given lumen values are net delivered luminaire output lumens.	Les valeurs de lumens données sont les lumens de sortie nets du luminaire.
Given power values are total consumed AC power of the luminaire.	Les valeurs de puissance données sont la puissance AC totale consommée du luminaire.

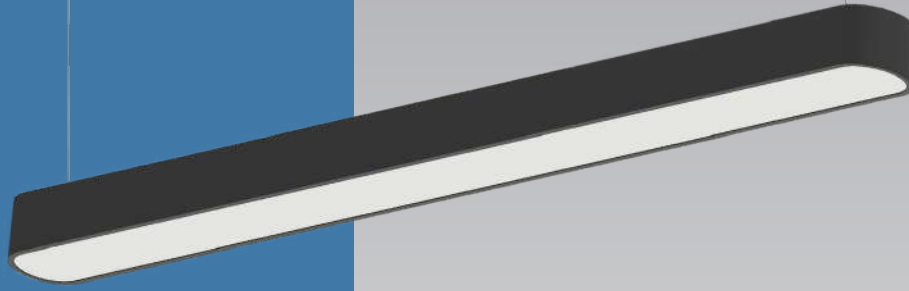

GALAKSI LINEAR

LED

Suspended Lighting Fixtures With Frosted Diffuser

Luminaire suspendus Avec Diffuseur Givré

APPLICATION AREAS

Shopping Malls
Supermarkets
Offices
Meeting rooms
Stores
Hospitals
Schools
Corridors

DOMAINES D'UTILISATION

Centres Commerciaux
Supermarchés
Bureaux
Salles de Réunions
Magasins
Hopitaux
Ecoles
Couloirs

BODY

Anodized aluminum with satin finishing. Black and white color options with elegant design.

DIFFUSER

UV stabilized frosted diffuser.

CONVERTER

Long life, low power loss converter with constant current. Compatible with ENEC standards.

LED

LED modules with 60.000 hours lifetime LUMILEDS / SAMSUNG / NICHIA brand LEDs.

SUSPENSION

Composed of 1mm steel wire rope and nickel-plated brass components. Suspension height is adjustable. Supplied with transparent electric cord and ceiling mounted electrical junction box with aesthetic design

CORPS

Corps en aluminium anodisé, satiné. Design élégant. Couleurs blanc, noir disponibles.

DIFFUSEUR

Diffuseur givré. Anti UV.

CONVERTEUR

Convertisseur, conforme aux normes ENEC. Longue vie. Perte de puissance faible avec courant constant .

LED

Modules LED – Durée de vie 60.000 heures avec LED de marque LUMILEDS / SAMSUNG / NICHIA.

SYSTEME DE FIXATION

Composé d'un fil en acier de 1mm , de composants en laiton nickelés. Livré avec un cordon électrique transparent et une boîte de jonction électrique à fixer au plafond. Hauteur de fixation réglable.

Color Options
Options de Couleur



LED Type / Type LED

Color Rendering Index / Indice de Rendu des Couleurs: (CRI): Ra>80

Kod Code	Power Puissance (W)	LED Type Type De LED	LED Module Module LED	Lum. Flux Flux Lum. (lm)	Color Temperature Température De Couleur (K)	Dimensions (mm)			Weight Poids (kg)	Packing Quantity Colisage	Pcs./20" Container Pcs./20" Conteneur
						a	l	h			
PL8SL12L15C	14	2835 SMD	PCB	1370	2700 - 6500	90	598	73	1,8	1	4320
PL8SL12L25C	21	2835 SMD	PCB	2055	2700 - 6500	90	598	73	1,8	1	4320
PL8SL13L15C	21	2835 SMD	PCB	2055	2700 - 6500	90	879	73	2,4	1	4320
PL8SL13L25C	30	2835 SMD	PCB	3080	2700 - 6500	90	879	73	2,4	1	4320
PL8SL14L15C	26	2835 SMD	PCB	2740	2700 - 6500	90	1159	73	3,0	1	3060
PL8SL14L25C	41	2835 SMD	PCB	4110	2700 - 6500	90	1159	73	3,0	1	3060
PL8SL15L15C	33	2835 SMD	PCB	3420	2700 - 6500	90	1440	73	3,8	1	2460
PL8SL15L25C	51	2835 SMD	PCB	5130	2700 - 6500	90	1440	73	3,8	1	2460
PL8SL16L15C	39	2835 SMD	PCB	4105	2700 - 6500	90	1721	73	4,7	1	2270
PL8SL16L25C	61	2835 SMD	PCB	6160	2700 - 6500	90	1721	73	4,7	1	2270
PL8SL17L15C	47	2835 SMD	PCB	4790	2700 - 6500	90	2000	73	5,5	1	1870
PL8SL17L25C	70	2835 SMD	PCB	7185	2700 - 6500	90	2000	73	5,5	1	1870
PL8SL18L15C	53	2835 SMD	PCB	5475	2700 - 6500	90	2282	73	6,2	1	1870
PL8SL19L15C	60	2835 SMD	PCB	6160	2700 - 6500	90	2562	73	6,9	1	1490
PL8SL10L15C	66	2835 SMD	PCB	6840	2700 - 6500	90	2843	73	7,6	1	1480

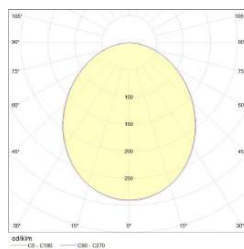

V / Hz 220 - 240 / 50 - 60

Options	Options
Dimmable electronic ballast or convertor. Emergency kit	Ballast électronique dimmable ou converteur. Kit d'urgence.
NOTE	NOTE
Given lumen values are net delivered luminaire output lumens.	Les valeurs de lumens données sont les lumens de sortie nets du luminaire.
Given power values are total consumed AC power of the luminaire.	Les valeurs de puissance données sont la puissance AC totale consommée du luminaire.

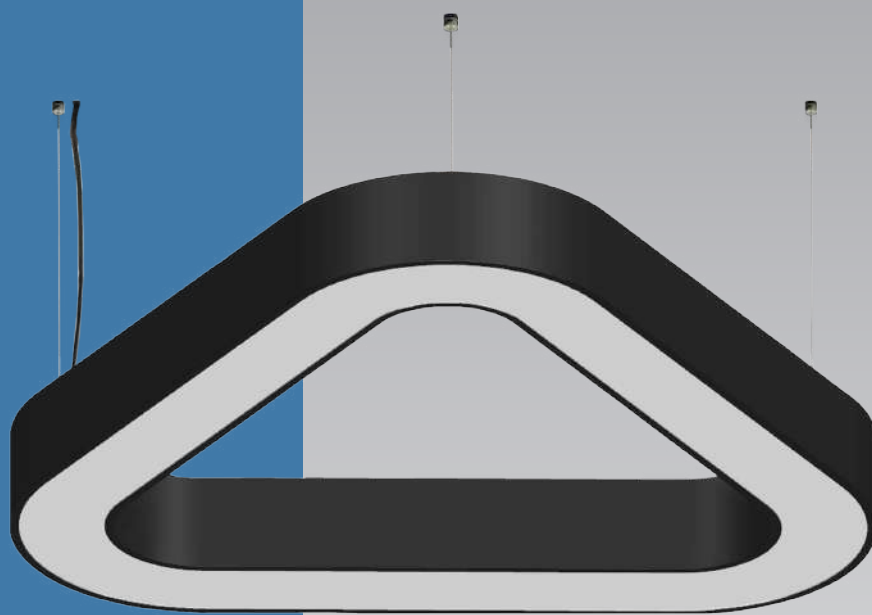

GALAKSI TRIANGLE

LED

Suspended Lighting Fixtures With Frosted Diffuser

Luminaire Suspendus Avec Diffuseur Givré

APPLICATION AREAS

Shopping Malls
Supermarkets
Offices
Meeting rooms
Stores
Hospitals
Schools
Corridors

DOMAINES D'UTILISATION

Centres Commerciaux
Supermarchés
Bureaux
Salles de Réunions
Magasins
Hopitaux
Ecoles
Couloirs

BODY

Anodized aluminum with satin finishing. Black and white color options with elegant design.

DIFFUSER

UV stabilized frosted diffuser.

CONVERTER

Long life, low power loss converter with constant current. Compatible with ENEC standards.

LED

LED modules with 60.000 hours lifetime LUMILEDS / SAMSUNG / NICHIA brand LEDs.

SUSPENSION

Composed of 1mm steel wire rope and nickel-plated brass components. Suspension height is adjustable. Supplied with transparent electric cord and ceiling mounted electrical junction box with aesthetic design

CORPS

Corps en aluminium anodisé, satiné. Design élégant. Couleurs blanc, noir disponibles.

DIFFUSEUR

Diffuseur givré. Anti UV.

CONVERTEUR

Convertisseur, conforme aux normes ENEC. Longue vie. Perte de puissance faible avec courant constant.

LED

Modules LED – Durée de vie 60.000 heures avec LED de marque LUMILEDS / SAMSUNG / NICHIA.

SYSTEME DE FIXATION

Composé d'un fil en acier de 1mm, de composants en laiton nickelés. Livré avec un cordon électrique transparent et une boîte de jonction électrique à fixer au plafond. Hauteur de fixation réglable.

Color Options
Options de Couleur



LED Type / Type LED

Color Rendering Index / Indice de Rendu des Couleurs: (CRI): Ra>80

Kod Code	Power Puissance (W)	LED Type Type De LED	LED Module Module LED	Lum. Flux Flux Lum. (lm)	Color Temperature Température De Couleur (K)	Dimensions (mm)			Weight Poids (kg)	Packing Quantity Colisage	Pcs./20" Container Pcs./20" Conteneur	
						a	b	h				
PL8ST6L15C	39	2835 SMD	PCB	3880	2700 - 6500	634	581	73	4.2	1	550	
PL8ST6L25C	61	2835 SMD	PCB	5835	2700 - 6500	634	581	73	4.3	1	550	
PL8ST9L15C	60	2835 SMD	PCB	5815	2700 - 6500	904	846	73	6.1	1	270	
PL8ST9L25C	90	2835 SMD	PCB	8755	2700 - 6500	904	846	73	6.3	1	270	
PL8ST12L15C	79	2835 SMD	PCB	7755	2700 - 6500	1184	1106	73	8.1	1	160	
PL8ST12L25C	120	2835 SMD	PCB	11670	2700 - 6500	1184	1106	73	8.3	1	160	

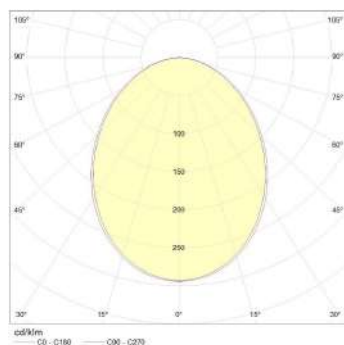
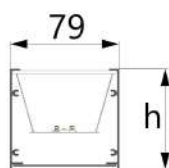
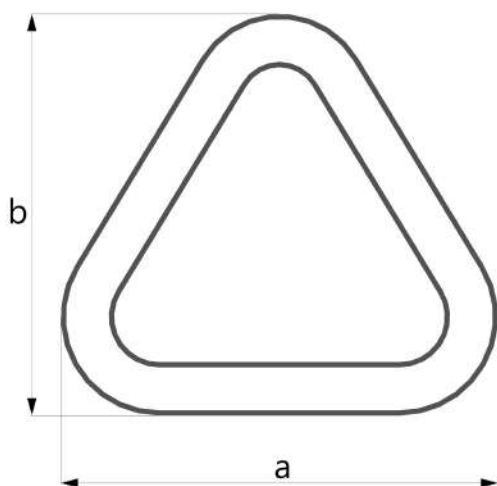

V / Hz 220 - 240 / 50 - 60

Options	Options
Dimmable electronic ballast or convertor. Emergency kit	Ballast électronique dimmable ou converteur. Kit d'urgence.
NOTE	NOTE
Given lumen values are net delivered luminaire output lumens.	Les valeurs de lumens données sont les lumens de sortie nets du luminaire.
Given power values are total consumed AC power of the luminaire.	Les valeurs de puissance données sont la puissance AC totale consommée du luminaire.



GALAKSI HEXAGON

LED

Suspended Lighting Fixtures With Frosted Diffuser

Luminaire Suspendus Avec Diffuseur Givré

APPLICATION AREAS

Shopping Malls
Supermarkets
Offices
Meeting rooms
Stores
Hospitals
Schools
Corridors

DOMAINES D'UTILISATION

Centres Commerciaux
Supermarchés
Bureaux
Salles de Réunions
Magasins
Hopitaux
Ecoles
Couloirs

BODY

Anodized aluminum with satin finishing. Black and white color options with elegant design.

DIFFUSER

UV stabilized frosted diffuser.

CONVERTER

Long life, low power loss converter with constant current. Compatible with ENEC standards.

LED

LED modules with 60.000 hours lifetime LUMILEDS / SAMSUNG / NICHIA brand LEDs.

SUSPENSION

Composed of 1mm steel wire rope and nickel-plated brass components. Suspension height is adjustable. Supplied with transparent electric cord and ceiling mounted electrical junction box with aesthetic design

CORPS

Corps en aluminium anodisé, satiné. Design élégant. Couleurs blanc, noir disponibles.

DIFFUSEUR

Diffuseur givré. Anti UV.

CONVERTEUR

Convertisseur, conforme aux normes ENEC. Longue vie. Perte de puissance faible avec courant constant .

LED

Modules LED – Durée de vie 60.000 heures avec LED de marque LUMILEDS / SAMSUNG / NICHIA.

SYSTEME DE FIXATION

Composé d'un fil en acier de 1mm , de composants en laiton nickelés. Livré avec un cordon électrique transparent et une boîte de jonction électrique à fixer au plafond. Hauteur de fixation réglable.

Color Options
Options de Couleur



LED Type / Type LED

Color Rendering Index / Indice de Rendu des Couleurs: (CRI): Ra>80

Code	Power Puissance (W)	LED Type Type De LED	LED Module Module LED	Lum. Flux Flux Lum. (lm)	Color Temperature Température De Couleur (K)	Dimensions (mm)				Weight Poids (kg)	Packing Quantity Colisage	Pcs./20" Container Pcs./20" Conteneur
						a	b	c	h			
PL8SA73E15C	73	2835 SMD	PCB	8050	2700 - 6500	800	693	400	94	7.8	1	430

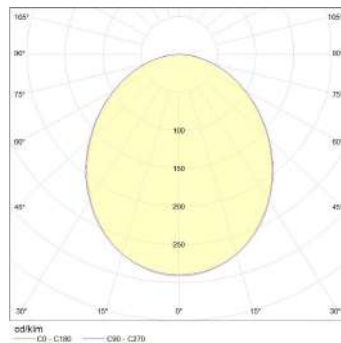
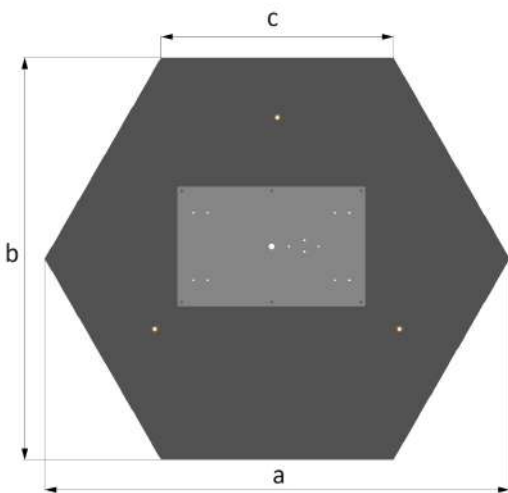

V / Hz 220 - 240 / 50 - 60

Options Dimmable electronic ballast or convertor. Emergency kit	Options Ballast électronique dimmable ou converteur. Kit d'urgence.
NOTE Given lumen values are net delivered luminaire output lumens.	NOTE Les valeurs de lumens données sont les lumens de sortie nets du luminaire.
NOTE Given power values are total consumed AC power of the luminaire.	NOTE Les valeurs de puissance données sont la puissance AC totale consommée du luminaire.



GALAKSI DOLUNAY HORIZON

LED

Suspended Lighting Fixtures With Frosted Diffuser

Luminaire suspendus Avec Diffuseur Givré

APPLICATION AREAS

Shopping Malls
Supermarkets
Offices
Meeting rooms
Stores
Hospitals
Schools
Corridors

DOMAINES D'UTILISATION

Centres Commerciaux
Supermarchés
Bureaux
Salles de Réunions
Magasins
Hopitaux
Ecoles
Couloirs

BODY

Anodized aluminum with satin finishing. Black and white color options with elegant design.

DIFFUSER

UV stabilized frosted diffuser.

CONVERTER

Long life, low power loss converter with constant current. Compatible with ENEC standards.

LED

LED modules with 60.000 hours lifetime LUMILEDS / SAMSUNG / NICHIA brand LEDs.

SUSPENSION

Composed of 1mm steel wire rope and nickel-plated brass components. Suspension height is adjustable. Supplied with transparent electric cord and ceiling mounted electrical junction box with aesthetic design

CORPS

Corps en aluminium anodisé, satiné. Design élégant. Couleurs blanc, noir disponibles.

DIFFUSEUR

Diffuseur givré. Anti UV.

CONVERTEUR

Convertisseur, conforme aux normes ENEC. Longue vie. Perte de puissance faible avec courant constant .

LED

Modules LED – Durée de vie 60.000 heures avec LED de marque LUMILEDS / SAMSUNG / NICHIA.

SYSTEME DE FIXATION

Composé d'un fil en acier de 1mm , de composants en laiton nickelés. Livré avec un cordon électrique transparent et une boîte de jonction électrique à fixer au plafond. Hauteur de fixation réglable.

Color Options
Options de Couleur



LED Type / Type LED

Color Rendering Index / Indice de Rendu des Couleurs: (CRI): Ra>80

Code	Power Puissance (W)	LED Type Type De LED	LED Module Module LED	Lum. Flux Flux Lum. (lm)	Color Temperature Température De Couleur (K)	Dimensions (mm) d h		Weight Poids (kg)	Packing Quantity Colisage	Pcs./20" Container Pcs./20" Conteneur
PL8SH16K12C	16	2835 SMD	PCB	1875	2700 - 6500	360	94	3.1	1	1176
PL8SH20K13C	20	2835 SMD	PCB	2310	2700 - 6500	360	94	3.1	1	1176
PL8SH24K14C	24	2835 SMD	PCB	2645	2700 - 6500	360	94	3.1	1	1176
PL8SH23K12C	23	2835 SMD	PCB	3035	2700 - 6500	470	94	5.2	1	730
PL8SH30K13C	30	2835 SMD	PCB	3715	2700 - 6500	470	94	5.2	1	730
PL8SH36K14C	36	2835 SMD	PCB	4305	2700 - 6500	470	94	5.2	1	730
PL8SH36K12C	36	2835 SMD	PCB	4760	2700 - 6500	600	94	6.5	1	470
PL8SH46K13C	46	2835 SMD	PCB	5840	2700 - 6500	600	94	6.5	1	470
PL8SH57K14C	57	2835 SMD	PCB	6785	2700 - 6500	600	94	6.5	1	470
PL8SH78K12C	78	2835 SMD	PCB	10625	2700 - 6500	900	94	7.2	1	220
PL8SH100K13C	100	2835 SMD	PCB	13000	2700 - 6500	900	94	7.2	1	220
PL8SH119K14C	119	2835 SMD	PCB	15080	2700 - 6500	900	94	7.2	1	220
PL8SH153K12C	153	2835 SMD	PCB	20600	2700 - 6500	1200	94	9.3	1	125
PL8SH200K13C	200	2835 SMD	PCB	25850	2700 - 6500	1200	94	9.3	1	125
PL8SH243K14C	243	2835 SMD	PCB	30100	2700 - 6500	1200	94	9.3	1	125

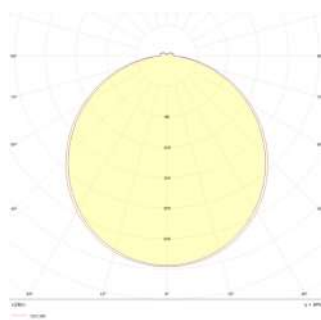
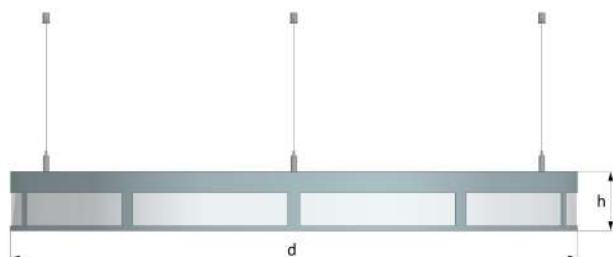

V / Hz	220 - 240 / 50 - 60
Options	Options
Dimmable electronic ballast or convertor. Emergency kit	Ballast électronique dimmable ou converteur. Kit d'urgence.
NOTE	NOTE
Given lumen values are net delivered luminaire output lumens.	Les valeurs de lumens données sont les lumens de sortie nets du luminaire.
Given power values are total consumed AC power of the luminaire.	Les valeurs de puissance données sont la puissance AC totale consommée du luminaire.



GALAKSI DOLUNAY DIRECT / INDIRECT

LED

Suspended Lighting Fixtures With Frosted Diffuser

Luminaire Suspendus Avec Diffuseur Givré

APPLICATION AREAS

Shopping Malls
Supermarkets
Offices
Meeting rooms
Stores
Hospitals
Schools
Corridors

DOMAINES D'UTILISATION

Centres Commerciaux
Supermarchés
Bureaux
Salles de Réunions
Magasins
Hopitaux
Ecoles
Couloirs

BODY

Anodized aluminum with satin finishing. Black and white color options with elegant design.

DIFFUSER

UV stabilized frosted diffuser.

CONVERTER

Long life, low power loss converter with constant current. Compatible with ENEC standards.

LED

LED modules with 60.000 hours lifetime LUMILEDS / SAMSUNG / NICHIA brand LEDs.

SUSPENSION

Composed of 1mm steel wire rope and nickel-plated brass components. Suspension height is adjustable. Supplied with transparent electric cord and ceiling mounted electrical junction box with aesthetic design

CORPS

Corps en aluminium anodisé, satiné. Design élégant. Couleurs blanc, noir disponibles.

DIFFUSEUR

Diffuseur givré. Anti UV.

CONVERTEUR

Convertisseur, conforme aux normes ENEC. Longue vie. Perte de puissance faible avec courant constant.

LED

Modules LED – Durée de vie 60.000 heures avec LED de marque LUMILEDS / SAMSUNG / NICHIA.

SYSTEME DE FIXATION

Composé d'un fil en acier de 1mm, de composants en laiton nickelés. Livré avec un cordon électrique transparent et une boîte de jonction électrique à fixer au plafond. Hauteur de fixation réglable.

Indirect Lighting
Éclairage Indirect

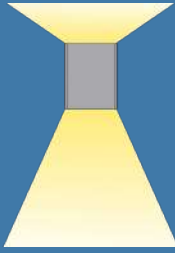

Direct Lighting
Éclairage Direct

Color Options
Options de Couleur



LED Type / Type LED

Color Rendering Index / Indice de Rendu des Couleurs: (CRI): Ra>80

Code	Power Puissance (W)	LED Type Type De LED	LED Module Module LED	Lum. Flux Flux Lum. (lm)	Color Temperature Température De Couleur (K)	Dimensions (mm) d h		Weight Poids (kg)	Packing Quantity Colisage	Pcs./20" Container Pcs./20" Conteneur
PL8ESD16K12C	16 / 10	2835 SMD	PCB/9	1740 / 1170	2700 - 6500	360	94	3.1	1	1176
PL8ESD20K13C	20 / 10	2835 SMD	PCB/9	2145 / 1170	2700 - 6500	360	94	3.1	1	1176
PL8ESD24K14C	24 / 10	2835 SMD	PCB/9	2455 / 1170	2700 - 6500	360	94	3.1	1	1176
PL8ESD23K12C	23 / 14	2835 SMD	PCB/12	2815 / 1560	2700 - 6500	470	94	5.2	1	730
PL8ESD30K13C	30 / 14	2835 SMD	PCB/12	3450 / 1560	2700 - 6500	470	94	5.2	1	730
PL8ESD36K14C	36 / 14	2835 SMD	PCB/12	3995 / 1560	2700 - 6500	470	94	5.2	1	730
PL8ESD36K12C	36 / 18	2835 SMD	PCB/15	4420 / 1950	2700 - 6500	600	94	6.5	1	470
PL8ESD46K13C	46 / 18	2835 SMD	PCB/15	5420 / 1950	2700 - 6500	600	94	6.5	1	470
PL8ESD57K14C	57 / 18	2835 SMD	PCB/15	6300 / 1950	2700 - 6500	600	94	6.5	1	470
PL8ESD78K12C	78 / 28	2835 SMD	PCB/24	9865 / 3120	2700 - 6500	900	94	7.2	1	220
PL8ESD100K13C	100 / 28	2835 SMD	PCB/24	12075 / 3120	2700 - 6500	900	94	7.2	1	220
PL8ESD119K14C	119 / 28	2835 SMD	PCB/24	14000 / 3120	2700 - 6500	900	94	7.2	1	220
PL8ESD153K12C	153 / 35	2835 SMD	PCB/30	19125 / 3900	2700 - 6500	1200	94	9.3	1	125
PL8ESD200K13C	200 / 35	2835 SMD	PCB/30	24000 / 3900	2700 - 6500	1200	94	9.3	1	125
PL8ESD243K14C	243 / 35	2835 SMD	PCB/30	27945 / 3900	2700 - 6500	1200	94	9.3	1	125

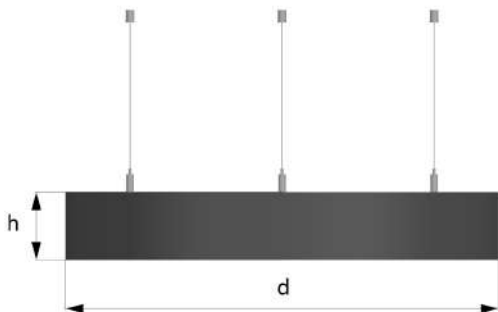

In-Direct Side LED Type / Type de LED Côté Indirecte

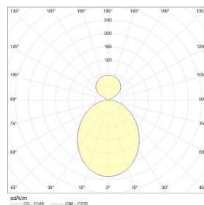

V / Hz 220 - 240 / 50 - 60

Options	Options
Dimmable electronic ballast or convertor.	Ballast électronique dimmable ou converteur.
Emergency kit	Kit d'urgence.
NOTE	NOTE
Given lumen values are net delivered luminaire output lumens.	Les valeurs de lumens données sont les lumens de sortie nets du luminaire.
Given power values are total consumed AC power of the luminaire.	Les valeurs de puissance données sont la puissance AC totale consommée du luminaire.



GALAKSI DOLUNAY

LED

Suspended Lighting Fixtures With Frosted Diffuser

Luminaire Suspendus Avec Diffuseur Givré

APPLICATION AREAS

Shopping Malls
Supermarkets
Offices
Meeting rooms
Stores
Hospitals
Schools
Corridors

DOMAINES D'UTILISATION

Centres Commerciaux
Supermarchés
Bureaux
Salles de Réunions
Magasins
Hopitaux
Ecoles
Couloirs

BODY

Anodized aluminum with satin finishing. Black and white color options with elegant design.

DIFFUSER

UV stabilized frosted diffuser.

CONVERTER

Long life, low power loss converter with constant current. Compatible with ENEC standards.

LED

LED modules with 60.000 hours lifetime LUMILEDS / SAMSUNG / NICHIA brand LEDs.

SUSPENSION

Composed of 1mm steel wire rope and nickel-plated brass components. Suspension height is adjustable. Supplied with transparent electric cord and ceiling mounted electrical junction box with aesthetic design

CORPS

Corps en aluminium anodisé, satiné. Design élégant. Couleurs blanc, noir disponibles.

DIFFUSEUR

Diffuseur givré. Anti UV.

CONVERTEUR

Convertisseur, conforme aux normes ENEC. Longue vie. Perte de puissance faible avec courant constant.

LED

Modules LED – Durée de vie 60.000 heures avec LED de marque LUMILEDS / SAMSUNG / NICHIA.

SYSTEME DE FIXATION

Composé d'un fil en acier de 1mm, de composants en laiton nickelés. Livré avec un cordon électrique transparent et une boîte de jonction électrique à fixer au plafond. Hauteur de fixation réglable.

Color Options
Options de Couleur



LED Type / Type LED

Color Rendering Index / Indice de Rendu des Couleurs: (CRI): Ra>80

Code	Power Puissance (W)	LED Type Type De LED	LED Module Module LED	Lum. Flux Flux Lum. (lm)	Color Temperature Température De Couleur (K)	Dimensions (mm) d h	Weight Poids (kg)	Packing Quantity Colisage	Pcs./20" Container Pcs./20" Conteneur
PL8SD16K12C	16	2835 SMD	PCB	1740	2700 - 6500	360 94	3.1	1	1176
PL8SD20K13C	20	2835 SMD	PCB	2145	2700 - 6500	360 94	3.1	1	1176
PL8SD24K14C	24	2835 SMD	PCB	2455	2700 - 6500	360 94	3.1	1	1176
PL8SD23K12C	23	2835 SMD	PCB	2815	2700 - 6500	470 94	5.2	1	730
PL8SD30K13C	30	2835 SMD	PCB	3450	2700 - 6500	470 94	5.2	1	730
PL8SD36K14C	36	2835 SMD	PCB	3995	2700 - 6500	470 94	5.2	1	730
PL8SD36K12C	36	2835 SMD	PCB	4420	2700 - 6500	600 94	6.5	1	470
PL8SD46K13C	46	2835 SMD	PCB	5420	2700 - 6500	600 94	6.5	1	470
PL8SD57K14C	57	2835 SMD	PCB	6300	2700 - 6500	600 94	6.5	1	470
PL8SD78K12C	78	2835 SMD	PCB	9865	2700 - 6500	900 94	7.2	1	220
PL8SD100K13C	100	2835 SMD	PCB	12075	2700 - 6500	900 94	7.2	1	220
PL8SD119K14C	119	2835 SMD	PCB	14000	2700 - 6500	900 94	7.2	1	220
PL8SD153K12C	153	2835 SMD	PCB	19125	2700 - 6500	1200 94	9.3	1	125
PL8SD200K13C	200	2835 SMD	PCB	24000	2700 - 6500	1200 94	9.3	1	125
PL8SD243K14C	243	2835 SMD	PCB	27945	2700 - 6500	1200 94	9.3	1	125

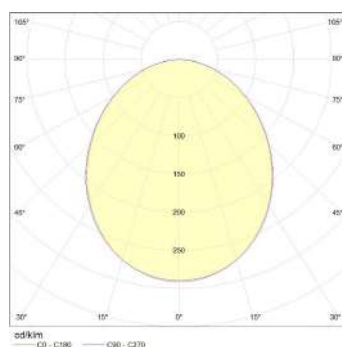
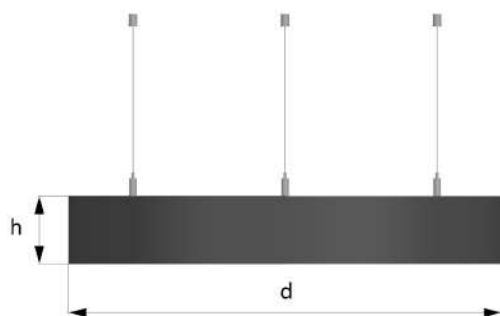

V / Hz 220 - 240 / 50 - 60

Options	Options
Dimmable electronic ballast or convertor. Emergency kit	Ballast électronique dimmable ou convertor. Kit d'urgence.
NOTE	NOTE
Given lumen values are net delivered luminaire output lumens.	Les valeurs de lumens données sont les lumens de sortie nets du luminaire.
Given power values are total consumed AC power of the luminaire.	Les valeurs de puissance données sont la puissance AC totale consommée du luminaire.



GALAKSI DOLUNAY

LED

Surface Mounted Lighting Fixtures With Frosted Diffuser

Luminaires Apparents Avec Diffuseur Givré

APPLICATION AREAS

Shopping Malls
Supermarkets
Offices
Meeting rooms
Stores
Hospitals
Schools

DOMAINES D'UTILISATION

Centres Commerciaux
Supermarchés
Bureaux
Salles de Réunions
Magasins
Hopitaux
Ecoles

BODY

Anodized aluminum with satin finishing. Black and white color options with elegant design.

DIFFUSER

UV stabilized frosted diffuser.

CONVERTER

Long life, low power loss converter with constant current. Compatible with ENEC standards.

LED

LED modules with 60.000 hours lifetime LUMILEDS / SAMSUNG / NICHIA brand LEDs.

CORPS

Corps en aluminium anodisé, satiné. Design élégant. Couleurs blanc, noir disponibles.

DIFFUSEUR

Diffuseur givré. Anti UV.

CONVERTEUR

Convertisseur, conforme aux normes ENEC. Longue vie. Perte de puissance faible avec courant constant.

LED

Modules LED – Durée de vie 60.000 heures avec LED de marque LUMILEDS / SAMSUNG / NICHIA.

Color Options
Options de Couleur



LED Type / Type LED

Color Rendering Index / Indice de Rendu des Couleurs: (CRI): Ra>80

Code	Power Puissance (W)	LED Type Type De LED	LED Module Module LED	Lum. Flux Flux Lum. (lm)	Color Temperature Température De Couleur (K)	Dimensions (mm) d h		Weight Poids (kg)	Packing Quantity Colisage	Pcs./20" Container Pcs./20" Conteneur
PL8UD16K12C	16	2835 SMD	PCB	1740	2700 - 6500	360	94	3.1	1	1176
PL8UD20K13C	20	2835 SMD	PCB	2145	2700 - 6500	360	94	3.1	1	1176
PL8UD24K14C	24	2835 SMD	PCB	2455	2700 - 6500	360	94	3.1	1	1176
PL8UD23K12C	23	2835 SMD	PCB	2815	2700 - 6500	470	94	5.2	1	730
PL8UD30K13C	30	2835 SMD	PCB	3450	2700 - 6500	470	94	5.2	1	730
PL8UD36K14C	36	2835 SMD	PCB	3995	2700 - 6500	470	94	5.2	1	730
PL8UD36K12C	36	2835 SMD	PCB	4420	2700 - 6500	600	94	6.5	1	470
PL8UD46K13C	46	2835 SMD	PCB	5420	2700 - 6500	600	94	6.5	1	470
PL8UD57K14C	57	2835 SMD	PCB	6300	2700 - 6500	600	94	6.5	1	470
PL8UD78K12C	78	2835 SMD	PCB	9865	2700 - 6500	900	94	7.2	1	220
PL8UD100K13C	100	2835 SMD	PCB	12075	2700 - 6500	900	94	7.2	1	220
PL8UD119K14C	119	2835 SMD	PCB	14000	2700 - 6500	900	94	7.2	1	220
PL8UD153K12C	153	2835 SMD	PCB	19125	2700 - 6500	1200	94	9.3	1	125
PL8UD200K13C	200	2835 SMD	PCB	24000	2700 - 6500	1200	94	9.3	1	125
PL8UD243K14C	243	2835 SMD	PCB	27945	2700 - 6500	1200	94	9.3	1	125

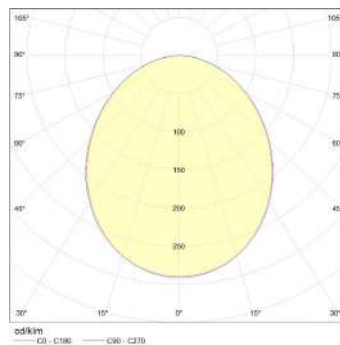
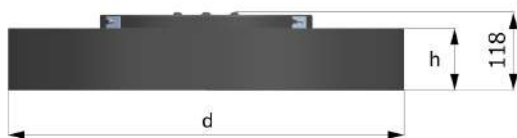

V / Hz 220 - 240 / 50 - 60

Options	Options
Dimmable electronic ballast or convertor. Emergency kit	Ballast électronique dimmable ou convertor. Kit d'urgence.
NOTE	NOTE
Given lumen values are net delivered luminaire output lumens.	Les valeurs de lumens données sont les lumens de sortie nets du luminaire.
Given power values are total consumed AC power of the luminaire.	Les valeurs de puissance données sont la puissance AC totale consommée du luminaire.

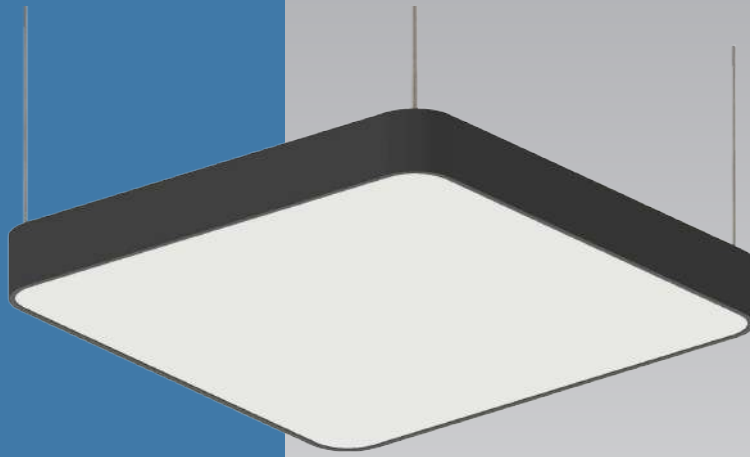

GALAKSI KARE

LED

Suspended Lighting Fixtures With Frosted Diffuser

Luminaire suspendus Avec Diffuseur Givré

APPLICATION AREAS

Shopping Malls
Supermarkets
Offices
Meeting rooms
Stores
Hospitals
Schools
Corridors

DOMAINES D'UTILISATION

Centres Commerciaux
Supermarchés
Bureaux
Salles de Réunions
Magasins
Hopitaux
Ecoles
Couloirs

BODY

Anodized aluminum with satin finishing. Black and white color options with elegant design.

DIFFUSER

UV stabilized frosted diffuser.

CONVERTER

Long life, low power loss converter with constant current. Compatible with ENEC standards.

LED

LED modules with 60.000 hours lifetime LUMILEDS / SAMSUNG / NICHIA brand LEDs.

SUSPENSION

Composed of 1mm steel wire rope and nickel-plated brass components. Suspension height is adjustable. Supplied with transparent electric cord and ceiling mounted electrical junction box with aesthetic design

CORPS

Corps en aluminium anodisé, satiné. Design élégant. Couleurs blanc, noir disponibles.

DIFFUSEUR

Diffuseur givré. Anti UV.

CONVERTEUR

Convertisseur, conforme aux normes ENEC. Longue vie. Perte de puissance faible avec courant constant.

LED

Modules LED – Durée de vie 60.000 heures avec LED de marque LUMILEDS / SAMSUNG / NICHIA.

SYSTEME DE FIXATION

Composé d'un fil en acier de 1mm, de composants en laiton nickelés. Livré avec un cordon électrique transparent et une boîte de jonction électrique à fixer au plafond. Hauteur de fixation réglable.

Color Options
Options de Couleur



LED Type / Type LED

Color Rendering Index / Indice de Rendu des Couleurs: (CRI): Ra>80

Code	Power Puissance (W)	LED Type Type De LED	LED Module Module LED	Lum. Flux Flux Lum. (lm)	Color Temperature Température De Couleur (K)	Dimensions (mm)			Weight Poids (kg)	Packing Quantity Colisage	Pcs./20" Container Pcs./20" Conteneur
						d1	d2	h			
PL8SDK11E06C	14	2835 SMD	PCB/350	1490	2700 - 6500	300	300	97	3.5	1	1700
PL8SDK12E04C	14	2835 SMD	PCB/350	1470	2700 - 6500	300	600	97	4.5	1	900
PL8SDK12E05C	20	2835 SMD	PCB/500	2100	2700 - 6500	300	600	97	4.5	1	900
PL8SDK13E04C	21	2835 SMD	PCB/350	2165	2700 - 6500	300	900	97	5.5	1	620
PL8SDK13E05C	29	2835 SMD	PCB/500	3150	2700 - 6500	300	900	97	5.5	1	620
PL8SDK14E04C	29	2835 SMD	PCB/350	3020	2700 - 6500	300	1160	97	6.5	1	490
PL8SDK14E05C	42	2835 SMD	PCB/500	4375	2700 - 6500	300	1160	97	6.5	1	490
PL8SDK22E04C	36	2835 SMD	PCB/900	3750	2700 - 6500	600	600	97	7.0	1	480
PL8SDK22E05C	42	2835 SMD	PCB/1050	4375	2700 - 6500	600	600	97	7.0	1	480
PL8SDK22E06C	56	2835 SMD	PCB/1400	5830	2700 - 6500	600	600	97	7.0	1	480
PL8SDK33E03C	62	2835 SMD	PCB/350	6570	2700 - 6500	900	900	97	7.5	1	230
PL8SDK33E05C	89	2835 SMD	PCB/500	9430	2700 - 6500	900	900	97	7.5	1	230
PL8SDK33E06C	125	2835 SMD	PCB/700	13245	2700 - 6500	900	900	97	7.5	1	230

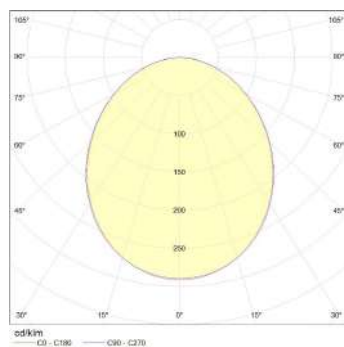
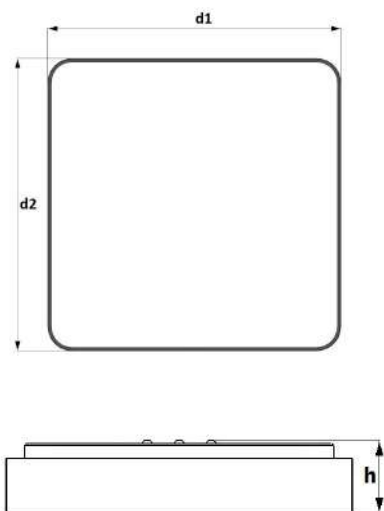

V / Hz 220 - 240 / 50 - 60

Options	Options
Dimmable electronic ballast or convertor. Emergency kit	Ballast électronique dimmable ou converteur. Kit d'urgence.
NOTE	NOTE
Given lumen values are net delivered luminaire output lumens.	Les valeurs de lumens données sont les lumens de sortie nets du luminaire.
Given power values are total consumed AC power of the luminaire.	Les valeurs de puissance données sont la puissance AC totale consommée du luminaire.



GALAKSI YONCA

LED

Suspended Lighting Fixtures With Frosted Diffuser

Luminaire suspendus Avec Diffuseur Givré

APPLICATION AREAS

Shopping Malls
Supermarkets
Offices
Meeting rooms
Stores
Hospitals
Schools
Corridors

DOMAINES D'UTILISATION

Centres Commerciaux
Supermarchés
Bureaux
Salles de Réunions
Magasins
Hopitaux
Ecoles
Couloirs

BODY

Anodized aluminum with satin finishing. Black and white color options with elegant design.

DIFFUSER

UV stabilized frosted diffuser.

CONVERTER

Long life, low power loss converter with constant current. Compatible with ENEC standards.

LED

LED modules with 60.000 hours lifetime LUMILEDS / SAMSUNG / NICHIA brand LEDs.

SUSPENSION

Composed of 1mm steel wire rope and nickel-plated brass components. Suspension height is adjustable. Supplied with transparent electric cord and ceiling mounted electrical junction box with aesthetic design

CORPS

Corps en aluminium anodisé, satiné. Design élégant. Couleurs blanc, noir disponibles.

DIFFUSEUR

Diffuseur givré. Anti UV.

CONVERTEUR

Convertisseur, conforme aux normes ENEC. Longue vie. Perte de puissance faible avec courant constant .

LED

Modules LED – Durée de vie 60.000 heures avec LED de marque LUMILEDS / SAMSUNG / NICHIA.

SYSTEME DE FIXATION

Composé d'un fil en acier de 1mm , de composants en laiton nickelés. Livré avec un cordon électrique transparent et une boîte de jonction électrique à fixer au plafond. Hauteur de fixation réglable.

Color Options
Options de Couleur



LED Type / Type LED

Color Rendering Index / Indice de Rendu des Couleurs: (CRI): Ra>80

Kod Code	Power Puissance (W)	LED Type Type De LED	LED Module Module LED	Lum. Flux Flux Lum. (lm)	Color Temperature Température De Couleur (K)	Dimensions (mm)			Weight Poids (kg)	Packing Quantity Colisage	Pcs./20" Container Pcs./20" Conteneur	
						a	b	h				
PL8SY15C	19	2835 SMD	PCB	1850	2700 - 6500	494	539	97	5,5	1	600	

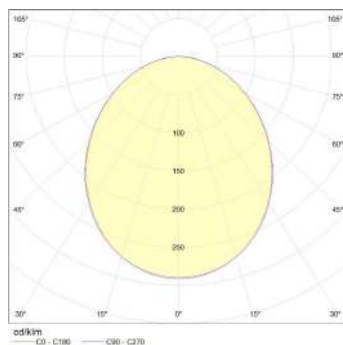
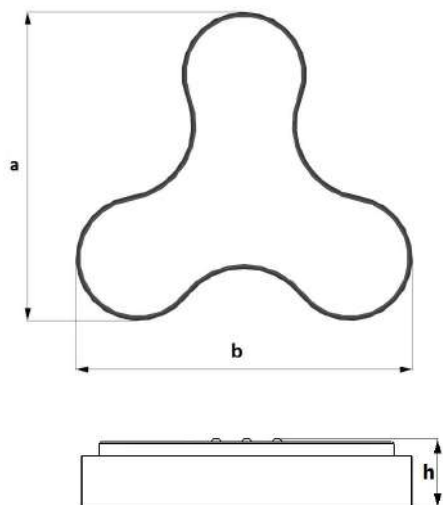

V / Hz 220 - 240 / 50 - 60

Options	Options
Dimmable electronic ballast or convertor. Emergency kit	Ballast électronique dimmable ou converteur. Kit d'urgence.
NOTE	NOTE
Given lumen values are net delivered luminaire output lumens. Given power values are total consumed AC power of the luminaire.	Les valeurs de lumens données sont les lumens de sortie nets du luminaire. Les valeurs de puissance données sont la puissance AC totale consommée du luminaire.



GALAKSI DOLUNAY RECESSED

LED

Recessed Lighting Fixtures With Frosted Diffuser

Luminaire Encastre Avec Diffuseur Givré

APPLICATION AREAS

Shopping Malls
Supermarkets
Offices
Meeting rooms
Stores
Hospitals
Schools

DOMAINES D'UTILISATION

Centres Commerciaux
Supermarchés
Bureaux
Salles de Réunions
Magasins
Hopitaux
Ecoles

BODY

Anodized aluminum with satin finishing. Black and white color options with elegant design.

DIFFUSER

UV stabilized frosted diffuser.

CONVERTER

Long life, low power loss converter with constant current. Compatible with ENEC standards.

LED

LED modules with 60.000 hours lifetime LUMILEDS / SAMSUNG / NICHIA brand LEDs.

CORPS

Corps en aluminium anodisé, satiné. Design élégant. Couleurs blanc, noir disponibles.

DIFFUSEUR

Diffuseur givré. Anti UV.

CONVERTEUR

Convertisseur, conforme aux normes ENEC. Longue vie. Perte de puissance faible avec courant constant.

LED

Modules LED – Durée de vie 60.000 heures avec LED de marque LUMILEDS / SAMSUNG / NICHIA.

Color Options
Options de Couleur



LED Type / Type LED

Color Rendering Index / Indice de Rendu des Couleurs: (CRI): Ra>80

Code	Power Puissance (W)	LED Type Type De LED	LED Module Module LED	Lum. Flux Flux Lum. (lm)	Color Temperature Température De Couleur (K)	Dimensions (mm)			Weight Poids (kg)	Packing Quantity Colisage	Pcs./20" Container Pcs./20" Conteneur
						d1	d2	h			
PL8AD23K12C	23	2835 SMD	PCB	2815	2700 - 6500	490	475	85	5.0	1	678
PL8AD30K13C	30	2835 SMD	PCB	3450	2700 - 6500	490	475	85	5.0	1	678
PL8AD36K14C	36	2835 SMD	PCB	3995	2700 - 6500	490	475	85	5.0	1	678
PL8AD36K12C	36	2835 SMD	PCB	4420	2700 - 6500	620	605	85	6.3	1	440
PL8AD46K13C	46	2835 SMD	PCB	5420	2700 - 6500	620	605	85	6.3	1	440
PL8AD57K14C	57	2835 SMD	PCB	6300	2700 - 6500	620	605	85	6.3	1	440
PL8AD78K12C	78	2835 SMD	PCB	9865	2700 - 6500	920	905	85	7.0	1	210
PL8AD100K13C	100	2835 SMD	PCB	12075	2700 - 6500	920	905	85	7.0	1	210
PL8AD119K14C	119	2835 SMD	PCB	14000	2700 - 6500	920	905	85	7.0	1	210
PL8AD153K12C	153	2835 SMD	PCB	19125	2700 - 6500	1220	1205	85	9.1	1	122
PL8AD200K13C	200	2835 SMD	PCB	24000	2700 - 6500	1220	1205	85	9.1	1	122
PL8AD243K14C	243	2835 SMD	PCB	27945	2700 - 6500	1220	1205	85	9.1	1	122

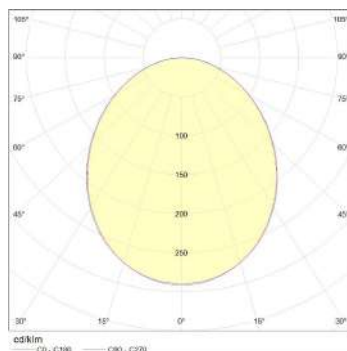
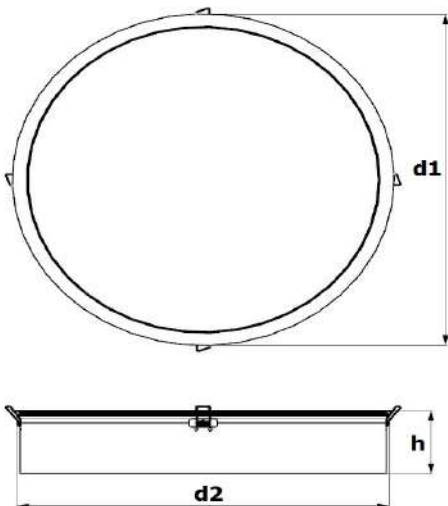

V / Hz 220 - 240 / 50 - 60

Options	Options
Dimmable electronic ballast or convertor. Emergency kit	Ballast électronique dimmable ou converteur. Kit d'urgence.
NOTE	NOTE
Given lumen values are net delivered luminaire output lumens.	Les valeurs de lumens données sont les lumens de sortie nets du luminaire.
Given power values are total consumed AC power of the luminaire.	Les valeurs de puissance données sont la puissance AC totale consommée du luminaire.



GALAKSI TRIMLESS DOLUNAY

LED

Recessed Lighting Fixtures With Frosted Diffuser

Luminaire Encastre Avec Diffuseur Givré

APPLICATION AREAS

Shopping Malls
Supermarkets
Offices
Meeting rooms
Stores
Hospitals
Schools

DOMAINES D'UTILISATION

Centres Commerciaux
Supermarchés
Bureaux
Salles de Réunions
Magasins
Hopitaux
Ecoles

BODY

Anodized aluminum with satin finishing. Black and white color options with elegant design.

DIFFUSER

UV stabilized frosted diffuser.

CONVERTER

Long life, low power loss converter with constant current. Compatible with ENEC standards.

LED

LED modules with 60.000 hours lifetime LUMILEDS / SAMSUNG / NICHIA brand LEDs.

CORPS

Corps en aluminium anodisé, satiné. Design élégant. Couleurs blanc, noir disponibles.

DIFFUSEUR

Diffuseur givré. Anti UV.

CONVERTEUR

Convertisseur, conforme aux normes ENEC. Longue vie. Perte de puissance faible avec courant constant.

LED

Modules LED – Durée de vie 60.000 heures avec LED de marque LUMILEDS / SAMSUNG / NICHIA.

Ceiling Mounting System
Système de Montage au Plafond

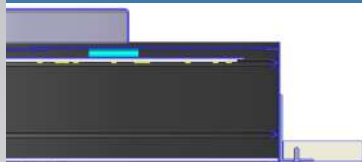

Color Options
Options de Couleur



LED Type / Type LED

Color Rendering Index / Indice de Rendu des Couleurs: (CRI): Ra>80

Code	Power Puissance (W)	LED Type Type De LED	LED Module Module LED	Lum. Flux Flux Lum. (lm)	Color Temperature Température De Couleur (K)	Dimensions (mm) d h		Weight Poids (kg)	Packing Quantity Colisage	Pcs./20" Container Pcs./20" Conteneur
PL8ATD23K12C	23	2835 SMD	PCB	2165	2700 - 6500	470	97	5.2	1	730
PL8ATD30K13C	30	2835 SMD	PCB	2650	2700 - 6500	470	97	5.2	1	730
PL8ATD36K14C	36	2835 SMD	PCB	3075	2700 - 6500	470	97	5.2	1	730
PL8ATD36K12C	36	2835 SMD	PCB	3400	2700 - 6500	600	97	6.5	1	470
PL8ATD46K13C	46	2835 SMD	PCB	4170	2700 - 6500	600	97	6.5	1	470
PL8ATD57K14C	57	2835 SMD	PCB	4845	2700 - 6500	600	97	6.5	1	470
PL8ATD78K12C	78	2835 SMD	PCB	7590	2700 - 6500	900	97	7.2	1	220
PL8ATD100K13C	100	2835 SMD	PCB	9290	2700 - 6500	900	97	7.2	1	220
PL8ATD119K14C	119	2835 SMD	PCB	10770	2700 - 6500	900	97	7.2	1	220

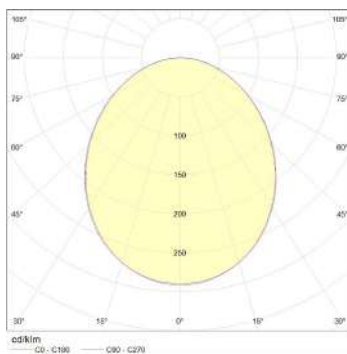

V / Hz 220 - 240 / 50 - 60

Options	Options
Dimmable electronic ballast or convertor. Emergency kit	Ballast électronique dimmable ou converteur. Kit d'urgence.
NOTE	NOTE
Given lumen values are net delivered luminaire output lumens.	Les valeurs de lumens données sont les lumens de sortie nets du luminaire.
Given power values are total consumed AC power of the luminaire.	Les valeurs de puissance données sont la puissance AC totale consommée du luminaire.



GALAKSI FREEDOM RECESSED

LED

Recessed Lighting Fixtures With Frosted Diffuser

Luminaire Encastré Avec Diffuseur Givré

APPLICATION AREAS

Shopping Malls
Supermarkets
Offices
Meeting rooms
Stores
Hospitals
Schools

DOMAINES D'UTILISATION

Centres Commerciaux
Supermarchés
Bureaux
Salles de Réunions
Magasins
Hopitaux
Ecoles

BODY

Anodized aluminum with satin finishing. Black and white color options with elegant design.

DIFFUSER

UV stabilized frosted diffuser.

CONVERTER

Long life, low power loss converter with constant current. Compatible with ENEC standards.

LED

LED modules with 60.000 hours lifetime LUMILEDS / SAMSUNG / NICHIA brand LEDs.

CORPS

Corps en aluminium anodisé, satiné. Design élégant. Couleurs blanc, noir disponibles.

DIFFUSEUR

Diffuseur givré. Anti UV.

CONVERTEUR

Convertisseur, conforme aux normes ENEC. Longue vie. Perte de puissance faible avec courant constant.

LED

Modules LED – Durée de vie 60.000 heures avec LED de marque LUMILEDS / SAMSUNG / NICHIA.

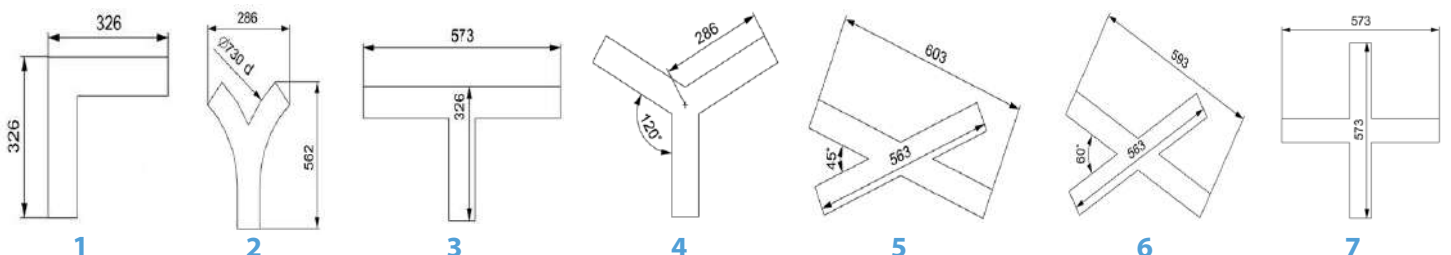

Color Options
Options de Couleur



LED Type / Type LED

Color Rendering Index / Indice de Rendu des Couleurs: (CRI): Ra>80

Code	Power Puissance (W)	LED Type Type De LED	LED Module Module LED	Lum. Flux Flux Lum. (lm)	Color Temperature Température De Couleur (K)	Dimensions (mm)			Weight Poids (kg)	Shape La Forme
						a	d	h		
PL8A180F4L15C	26	2835 SMD	PCB	2740	2700 - 6500	84	800	84	2,6	
PL8A180F5L15C	33	2835 SMD	PCB	3420	2700 - 6500	84	980	84	3,3	
PL8A180F6L15C	39	2835 SMD	PCB	4105	2700 - 6500	84	1155	84	3,9	
PL8A180F7L15C	47	2835 SMD	PCB	4790	2700 - 6500	84	1335	84	4,5	
PL8A180F8L15C	53	2835 SMD	PCB	5475	2700 - 6500	84	1500	84	5,1	
PL8A180F10L15C	66	2835 SMD	PCB	6840	2700 - 6500	84	1890	84	5,9	
PL8A180F12L15C	79	2835 SMD	PCB	8210	2700 - 6500	84	2255	84	6,7	
PL8A180F14L15C	92	2835 SMD	PCB	9580	2700 - 6500	84	2610	84	7,7	
PL8A180F16L15C	105	2835 SMD	PCB	10945	2700 - 6500	84	2950	84	8,6	
PL8A90F2L15C	14	2835 SMD	PCB	1370	2700 - 6500	84	800	84	1,5	
PL8A90F3L15C	21	2835 SMD	PCB	2055	2700 - 6500	84	1155	84	2,0	
PL8A90F4L15C	26	2835 SMD	PCB	2740	2700 - 6500	84	1500	84	2,6	
PL8A90F5L15C	33	2835 SMD	PCB	3420	2700 - 6500	84	1890	84	3,3	
PL8A90F6L15C	39	2835 SMD	PCB	4105	2700 - 6500	84	2255	84	3,9	
PL8A90F7L15C	47	2835 SMD	PCB	4790	2700 - 6500	84	2610	84	4,5	
PL8A90F8L15C	53	2835 SMD	PCB	5475	2700 - 6500	84	2950	84	5,1	
PL8A90F9L15C	60	2835 SMD	PCB	6160	2700 - 6500	84	3315	84	5,5	
PL8A90F10L15C	66	2835 SMD	PCB	6840	2700 - 6500	84	3675	84	5,9	
PL8A45F1L15C	8	2835 SMD	PCB	685	2700 - 6500	84	800	84	1,5	
PL8A45F2L15C	14	2835 SMD	PCB	1370	2700 - 6500	84	1500	84	1,5	
PL8A45F3L15C	21	2835 SMD	PCB	2055	2700 - 6500	84	2255	84	2,0	
PL8A45F4L15C	26	2835 SMD	PCB	2740	2700 - 6500	84	2950	84	2,6	
PL8A45F5L15C	33	2835 SMD	PCB	3420	2700 - 6500	84	3675	84	3,3	
Code	Power Puissance (W)	LED Type Type De LED	LED Module Module LED	Lum. Flux Flux Lum. (lm)	Color Temperature Température De Couleur (K)	Dimensions (mm)			Weight Poids (kg)	Shape La Forme
						a	l	h		
PL8ALF1L15C	8	2835 SMD	PCB	685	2700 - 6500	84	282	84	1,5	
PL8ALF2L15C	14	2835 SMD	PCB	1370	2700 - 6500	84	565	84	1,5	
PL8ALF3L15C	21	2835 SMD	PCB	2055	2700 - 6500	84	845	84	2,0	
PL8ALF4L15C	26	2835 SMD	PCB	2740	2700 - 6500	84	1125	84	2,6	
PL8ALF5L15C	33	2835 SMD	PCB	3420	2700 - 6500	84	1405	84	3,3	
PL8ALF6L15C	39	2835 SMD	PCB	4105	2700 - 6500	84	1685	84	3,9	
PL8ALF7L15C	47	2835 SMD	PCB	4790	2700 - 6500	84	1965	84	4,5	
PL8ALF8L15C	53	2835 SMD	PCB	5475	2700 - 6500	84	2254	84	5,1	
PL8ALF9L15C	60	2835 SMD	PCB	6160	2700 - 6500	84	2525	84	5,5	
PL8ALF10L15C	66	2835 SMD	PCB	6840	2700 - 6500	84	2810	84	5,9	
Code	Power Puissance (W)	LED Type Type De LED	LED Module Module LED	Lum. Flux Flux Lum. (lm)	Color Temperature Température De Couleur (K)	Dimensions (mm)		Weight Poids (kg)	Drawing No Dessin No	
						a	h			
PL8ACF2L15C	14	2835 SMD	PCB	1370	2700 - 6500	84	84	1,5	1	
PL8AA3FL15C	21	2835 SMD	PCB	2055	2700 - 6500	84	84	2,0	2	
PL8AT3FL15C	21	2835 SMD	PCB	2055	2700 - 6500	84	84	2,0	3	
PL8AY3FL15C	21	2835 SMD	PCB	2055	2700 - 6500	84	84	2,0	4	
PL8A45K4FL15C	26	2835 SMD	PCB	2740	2700 - 6500	84	84	2,6	5	
PL8A60K4FL15C	26	2835 SMD	PCB	2740	2700 - 6500	84	84	2,6	6	
PL8A90K4FL15C	26	2835 SMD	PCB	2740	2700 - 6500	84	84	2,6	7	

Visible Frame Width / Largeur de Cadre Visible: 95mm

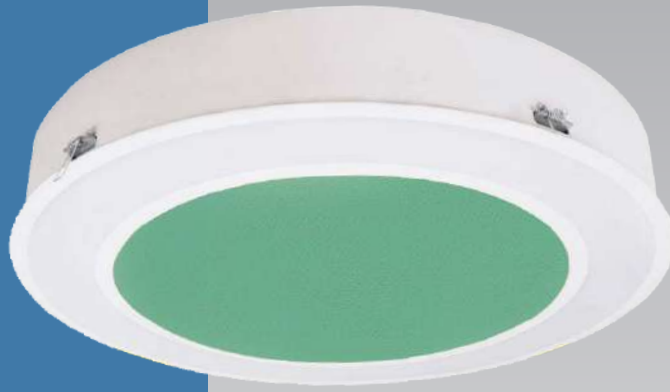

GALAKSI O TEXTILE ACOUSTIC RECESSED

LED

Recessed Lighting Fixtures With Frosted Diffuser & Special Textile
Luminaire Encastre Avec Diffuseur Givré et Textile Spéciale

APPLICATION AREAS

Shopping Malls
Supermarkets
Offices
Meeting rooms
Stores
Hospitals
Schools

DOMAINES D'UTILISATION

Centres Commerciaux
Supermarchés
Bureaux
Salles de Réunions
Magasins
Hopitaux
Ecoles

BODY

Anodized aluminum with satin finishing. Black and white color options with elegant design.

TEXTILE

Natural textile that absorbs excess noise in the environment.

DIFFUSER

UV stabilized frosted diffuser.

CONVERTER

Long life, low power loss converter with constant current. Compatible with ENEC standards.

LED

LED modules with 60.000 hours lifetime LUMILEDS / SAMSUNG / NICHIA brand LEDs.

CORPS

Corps en aluminium anodisé, satiné. Design élégant. Couleurs blanc, noir disponibles.

TEXTILE

Textile naturel qui absorbe l'excès de bruit dans l'environnement.

DIFFUSEUR

Diffuseur givré. Anti UV.

CONVERTEUR

Convertisseur, conforme aux normes ENEC. Longue vie. Perte de puissance faible avec courant constant.

LED

Modules LED – Durée de vie 60.000 heures avec LED de marque LUMILEDS / SAMSUNG / NICHIA.

V / Hz 220 - 240 / 50 - 60

Options	Options
Dimmable electronic ballast or convertor.	Ballast électronique dimmable ou converteur.
Emergency kit	Kit d'urgence.

NOTE	NOTE
Given lumen values are net delivered luminaire output lumens.	Les valeurs de lumens données sont les lumens de sortie nets du luminaire.
Given power values are total consumed AC power of the luminaire.	Les valeurs de puissance données sont la puissance AC totale consommée du luminaire.

Color Options
Options de Couleur



LED Type / Type LED

Color Rendering Index / Indice de Rendu des Couleurs: (CRI): Ra>80

Code	Power Puissance (W)	LED Type Type De LED	LED Module Module LED	Lum. Flux Flux Lum. (lm)	Color Temperature Température De Couleur (K)	Dimensions (mm)				Weight Poids (kg)	Packing Quantity Colisage	Pcs./20" Container Pcs./20" Conteneur
						D	d1	d2	h			
PL8AAT08L15C	53	2835 SMD	PCB	5170	2700 - 6500	820	807	635	84	6.5	1	260
PL8AAT010L15C	66	2835 SMD	PCB	6460	2700 - 6500	1000	987	815	84	7.2	1	180
PL8AAT012L15C	79	2835 SMD	PCB	8210	2700 - 6500	1175	1162	990	84	9.3	1	130
PL8AAT014L15C	92	2835 SMD	PCB	9580	2700 - 6500	1355	1342	1170	84	10.5	1	100
PL8AAT016L15C	105	2835 SMD	PCB	10945	2700 - 6500	1520	1507	1335	84	11.7	1	80
PL8AAT020L15C	132	2835 SMD	PCB	13680	2700 - 6500	1910	1897	1725	84	12.9	1	50
PL8AAT024L15C	158	2835 SMD	PCB	16420	2700 - 6500	2275	2262	2090	84	14.1	1	35

Fabric Color Options / Options de Couleur du Tissu

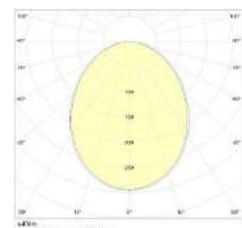
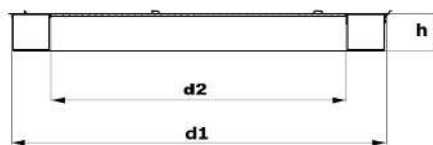
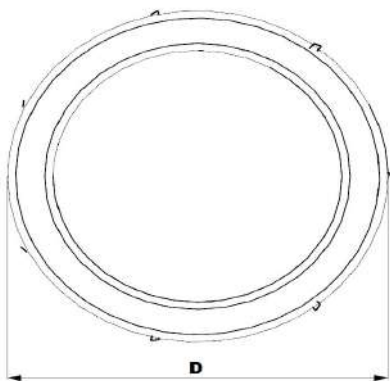
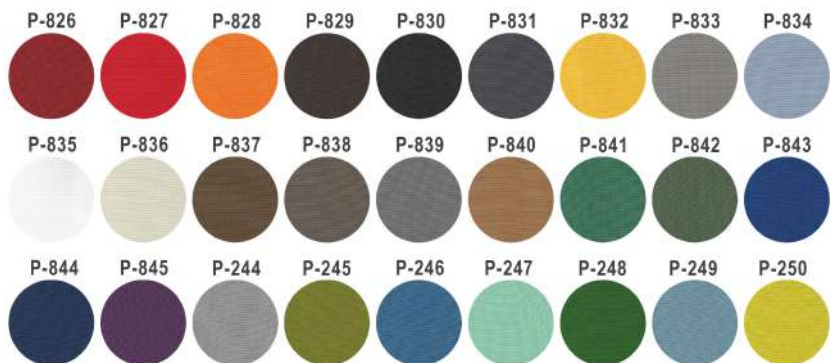



GALAKSI O RECESSED

LED

Recessed Lighting Fixtures With Frosted Diffuser

Luminaire Encastré Avec Diffuseur Givré

BODY

Anodized aluminum with satin finishing. Black and white color options with elegant design.

DIFFUSER

UV stabilized frosted diffuser.

CONVERTER

Long life, low power loss converter with constant current. Compatible with ENEC standards.

LED

LED modules with 60.000 hours lifetime LUMILEDS / SAMSUNG / NICHIA brand LEDs.

CORPS

Corps en aluminium anodisé, satiné. Design élégant. Couleurs blanc, noir disponibles.

DIFFUSEUR

Diffuseur givré. Anti UV.

CONVERTEUR

Convertisseur, conforme aux normes ENEC. Longue vie. Perte de puissance faible avec courant constant .

LED

Modules LED – Durée de vie 60.000 heures avec LED de marque LUMILEDS / SAMSUNG / NICHIA.

APPLICATION AREAS

Shopping Malls
Supermarkets
Offices
Meeting rooms
Stores
Hospitals
Schools

DOMAINES D'UTILISATION

Centres Commerciaux
Supermarchés
Bureaux
Salles de Réunions
Magasins
Hopitaux
Ecoles

Color Options
Options de Couleur



LED Type / Type LED

Color Rendering Index / Indice de Rendu des Couleurs: (CRI): Ra>80

Code	Power Puissance (W)	LED Type Type De LED	LED Module Module LED	Lum. Flux Flux Lum. (lm)	Color Temperature Température De Couleur (K)	Dimensions (mm)				Weight Poids (kg)	Packing Quantity Colisage	Pcs./20" Container Pcs./20" Conteneur
						D	d1	d2	h			
PL8A08L15C	53	2835 SMD	PCB	5170	2700 - 6500	820	807	635	84	6.5	1	260
PL8A010L15C	66	2835 SMD	PCB	6460	2700 - 6500	1000	987	815	84	7.2	1	180
PL8A012L15C	79	2835 SMD	PCB	8210	2700 - 6500	1175	1162	990	84	9.3	1	130
PL8A014L15C	92	2835 SMD	PCB	9580	2700 - 6500	1355	1342	1170	84	10.5	1	100
PL8A016L15C	105	2835 SMD	PCB	10945	2700 - 6500	1520	1507	1335	84	11.7	1	80
PL8A020L15C	132	2835 SMD	PCB	13680	2700 - 6500	1910	1897	1725	84	12.9	1	50
PL8A024L15C	158	2835 SMD	PCB	16420	2700 - 6500	2275	2262	2090	84	14.1	1	35

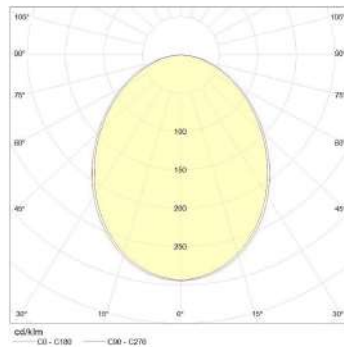
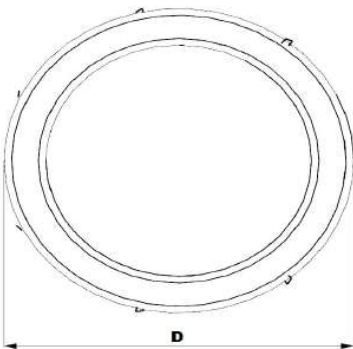
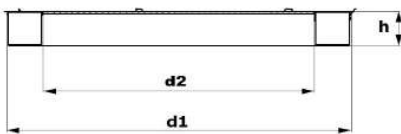

V / Hz 220 - 240 / 50 - 60

Options	Options
Dimmable electronic ballast or convertor. Emergency kit	Ballast électronique dimmable ou converteur. Kit d'urgence.
NOTE	NOTE
Given lumen values are net delivered luminaire output lumens.	Les valeurs de lumens données sont les lumens de sortie nets du luminaire.
Given power values are total consumed AC power of the luminaire.	Les valeurs de puissance données sont la puissance AC totale consommée du luminaire.

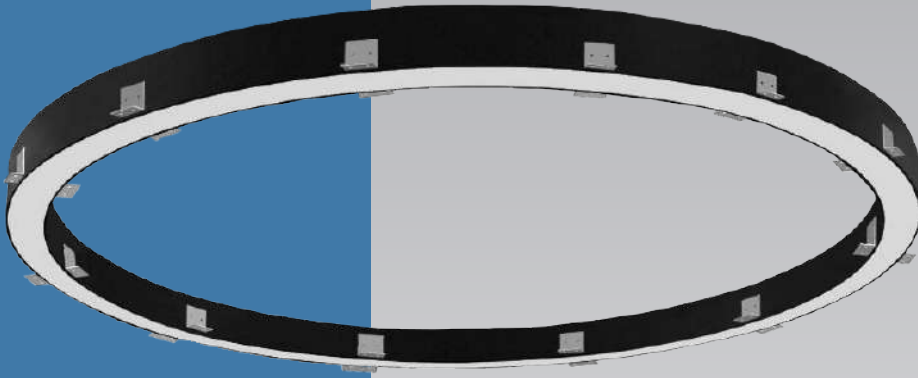

GALAKSI O TRIMLESS

LED

Recessed Lighting Fixtures With Frosted Diffuser

Luminaire Encastre Avec Diffuseur Givré

BODY

Anodized aluminum with satin finishing. Black and white color options with elegant design.

DIFFUSER

UV stabilized frosted diffuser.

CONVERTER

Long life, low power loss converter with constant current. Compatible with ENEC standards.

LED

LED modules with 60.000 hours lifetime LUMILEDS / SAMSUNG / NICHIA brand LEDs.

CORPS

Corps en aluminium anodisé, satiné. Design élégant. Couleurs blanc, noir disponibles.

DIFFUSEUR

Diffuseur givré. Anti UV.

CONVERTEUR

Convertisseur, conforme aux normes ENEC. Longue vie. Perte de puissance faible avec courant constant .

LED

Modules LED – Durée de vie 60.000 heures avec LED de marque LUMILEDS / SAMSUNG / NICHIA.

APPLICATION AREAS

Shopping Malls
Supermarkets
Offices
Meeting rooms
Stores
Hospitals
Schools

DOMAINES D'UTILISATION

Centres Commerciaux
Supermarchés
Bureaux
Salles de Réunions
Magasins
Hopitaux
Ecoles

Color Options
Options de Couleur



LED Type / Type LED

Color Rendering Index / Indice de Rendu des Couleurs: (CRI): Ra>80

Code	Power Puissance (W)	LED Type Type De LED	LED Module Module LED	Lum. Flux Flux Lum. (lm)	Color Temperature Température De Couleur (K)	Dimensions (mm)			Weight Poids (kg)	Packing Quantity Colisage	Pcs./20" Container Pcs./20" Conteneur
						d1	d2	h			
PL8AOT12L15C	79	2835 SMD	PCB	6610	2700 - 6500	1157	999	73	9.3	1	135
PL8AOT14L15C	92	2835 SMD	PCB	7715	2700 - 6500	1336	1178	73	10.5	1	105
PL8AOT16L15C	105	2835 SMD	PCB	8815	2700 - 6500	1500	1342	73	11.7	1	85
PL8AOT20L15C	132	2835 SMD	PCB	11020	2700 - 6500	1892	1734	73	12.9	1	55
PL8AOT22L15C	145	2835 SMD	PCB	12120	2700 - 6500	2070	1912	73	13.1	1	45
PL8AOT24L15C	158	2835 SMD	PCB	13220	2700 - 6500	2254	2096	73	14.5	1	35

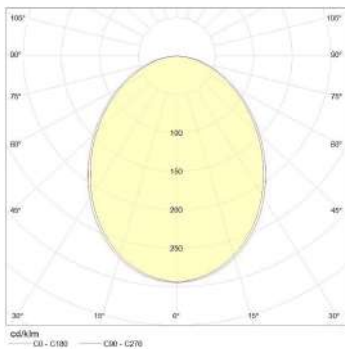
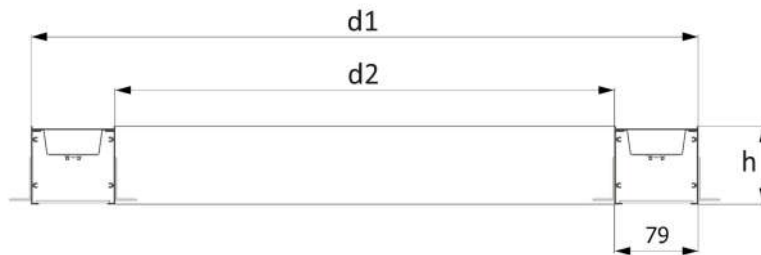

V / Hz 220 - 240 / 50 - 60

Options	Options
Dimmable electronic ballast or convertor.	Ballast électronique dimmable ou converteur.
Emergency kit	Kit d'urgence.
NOTE	NOTE
Given lumen values are net delivered luminaire output lumens.	Les valeurs de lumens données sont les lumens de sortie nets du luminaire.
Given power values are total consumed AC power of the luminaire.	Les valeurs de puissance données sont la puissance AC totale consommée du luminaire.





ELITE



ELITE DAISY DIRECT / INDIRECT

LED

Suspended Lighting Fixtures With Lens

Luminaire suspendus Avec Lentille

BODY

Anodized aluminum with satin finishing. Black and white color options with elegant design.

LENS

With 50° or 80° lens.

DIFFUSER

UV stabilized frosted diffuser.

CONVERTER

Compatible with ENEC standards.

LED

LED modules with 60.000 hours lifetime LUMILEDS / SAMSUNG / NICHIA brand LEDs.

SUSPENSION

Composed of 1mm steel wire rope and nickel-plated brass components. Suspension height is adjustable. Supplied with transparent electric cord and ceiling mounted electrical junction box with aesthetic design.

CORPS

Corps en aluminium anodisé, satiné. Design élégant. Couleurs blanc, noir disponibles.

LENS

Avec lentille 50° ou 80°.

DIFFUSEUR

Diffuseur givré. Anti UV.

CONVERTEUR

Convertisseur, conforme aux normes ENEC.

LED

Modules LED – Durée de vie 60.000 heures avec LED de marque LUMILEDS / SAMSUNG / NICHIA.

SYSTEME DE FIXATION

Composé d'un fil en acier de 1mm, de composants en laiton nickelés. Livré avec un cordon électrique transparent et une boîte de jonction électrique à fixer au plafond. Hauteur de fixation réglable.

APPLICATION AREAS

Shopping Malls
Supermarkets
Offices
Meeting rooms
Stores
Hospitals
Schools
Corridors

DOMAINES D'UTILISATION

Centres Commerciaux
Supermarchés
Bureaux
Salles de Réunions
Magasins
Hopitaux
Ecoles
Couloirs

V / Hz 220 - 240 / 50 - 60

Options	Options	NOTE	NOTE
Dimmable electronic ballast or convertor.	Ballast électronique dimmable ou converteur.	Given lumen values are net delivered luminaire output lumens.	Les valeurs de lumens données sont les lumens de sortie nets du luminaire.
Emergency kit	Kit d'urgence.	Given power values are total consumed AC power of the luminaire.	Les valeurs de puissance données sont la puissance AC totale consommée du luminaire.

Indirect Lighting
Éclairage Indirect

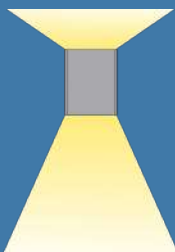

Direct Lighting
Éclairage Direct



Color Options
Options de Couleur



Direct / LED Type / Type LED

Color Rendering Index / Indice de Rendu des Couleurs: (CRI): Ra>80

Code	Power Puissance (W)	LED Type Type De LED	LED Module Module LED	Lum. Flux Flux Lum. (lm)	Color Temperature Température De Couleur (K)	Dimensions (mm)			Weight Poids (kg)	Packing Quantity Colisage	Pcs./20" Container Pcs./20" Conteneur
						a	l	h			
PL10S12L15L	16	2835 SMD	PCB	2000	2700 - 6500	47	578	73	1.2	2	3635
PL10S13L15L	22	2835 SMD	PCB	2995	2700 - 6500	47	858	73	1.7	2	3635
PL10S14L15L	29	2835 SMD	PCB	3995	2700 - 6500	47	1138	73	2.3	2	2835
PL10S15L15L	37	2835 SMD	PCB	4995	2700 - 6500	47	1418	73	2.9	2	2295
PL10S16L15L	44	2835 SMD	PCB	5990	2700 - 6500	47	1698	73	3.5	2	1970
PL10S17L15L	52	2835 SMD	PCB	6990	2700 - 6500	47	1978	73	4.0	2	1560
PL10S18L15L	60	2835 SMD	PCB	7985	2700 - 6500	47	2258	73	4.6	2	1560
PL10S19L15L	66	2835 SMD	PCB	8985	2700 - 6500	47	2538	73	5.2	2	1560
PL10S10L15L	75	2835 SMD	PCB	9985	2700 - 6500	47	2818	73	5.7	2	1255

In-Direct / LED Type / Type LED

Color Rendering Index / Indice de Rendu des Couleurs: (CRI): Ra>80

Code	Power Puissance (W)	LED Type Type De LED	LED Module Module LED	Lum. Flux Flux Lum. (lm)	Color Temperature Température De Couleur (K)	Dimensions (mm)			Weight Poids (kg)	Packing Quantity Colisage	Pcs./20" Container Pcs./20" Conteneur
						a	l	h			
PL10ES21L15L	16/8	2835 SMD	PCB	2000/665	2700 - 6500	47	578	73	1.3	2	3635
PL10ES32L15L	22/14	2835 SMD	PCB	2995/1330	2700 - 6500	47	858	73	1.8	2	3635
PL10ES43L15L	29/21	2835 SMD	PCB	3995/1995	2700 - 6500	47	1138	73	2.4	2	2835
PL10ES54L15L	37/26	2835 SMD	PCB	4995/2660	2700 - 6500	47	1418	73	3.0	2	2295
PL10ES65L15L	44/33	2835 SMD	PCB	5990/3325	2700 - 6500	47	1698	73	3.8	2	1970
PL10ES76L15L	52/39	2835 SMD	PCB	6990/3990	2700 - 6500	47	1978	73	4.3	2	1560
PL10ES87L15L	60/47	2835 SMD	PCB	7985/4655	2700 - 6500	47	2258	73	4.9	2	1560
PL10ES98L15L	66/53	2835 SMD	PCB	8985/5320	2700 - 6500	47	2538	73	5.8	2	1560
PL10ES109L15L	75/60	2835 SMD	PCB	9985/5985	2700 - 6500	47	2818	73	6.3	2	1255

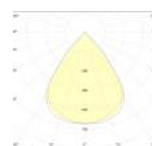
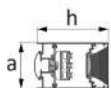

80° Light Beam

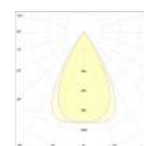

50° Light Beam

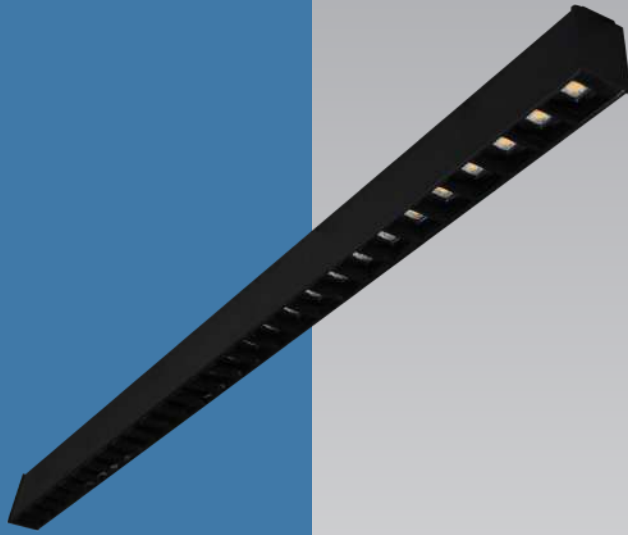

ELITE DAISY

LED

Surface Mounted Lighting Fixtures With Lens

Luminaire Apparents Avec Lentille

APPLICATION AREAS

Shopping Malls
Supermarkets
Offices
Meeting rooms
Stores
Hospitals
Schools
Corridors

DOMAINES D'UTILISATION

Centres Commerciaux
Supermarchés
Bureaux
Salles de Réunions
Magasins
Hopitaux
Ecoles
Couloirs

BODY

Anodized aluminum with satin finishing. Black and white color options with elegant design.

LENS

With 50° or 80° lens.

DIFFUSER

UV stabilized frosted diffuser.

CONVERTER

Compatible with ENEC standards.

LED

LED modules with 60.000 hours lifetime LUMILEDS / SAMSUNG / NICHIA brand LEDs.

CORPS

Corps en aluminium anodisé, satiné. Design élégant. Couleurs blanc, noir disponibles.

LENS

Avec lentille 50° ou 80°.

DIFFUSEUR

Diffuseur givré. Anti UV.

CONVERTEUR

Convertisseur, conforme aux normes ENEC.

LED

Modules LED – Durée de vie 60.000 heures avec LED de marque LUMILEDS / SAMSUNG / NICHIA.



Color Options
Options de Couleur



LED Type / Type LED

Color Rendering Index / Indice de Rendu des Couleurs: (CRI): Ra>80

Code	Power Puissance (W)	LED Type Type De LED	LED Module Module LED	Lum. Flux Flux Lum. (lm)	Color Temperature Température De Couleur (K)	Dimensions (mm)			Weight Poids (kg)	Packing Quantity Colisage	Pcs./20" Container Pcs./20" Conteneur
						a	l	h			
PL10U12L15L	16	2835 SMD	PCB	2000	2700 - 6500	47	578	73	1.2	2	3635
PL10U13L15L	22	2835 SMD	PCB	2995	2700 - 6500	47	858	73	1.7	2	3635
PL10U14L15L	29	2835 SMD	PCB	3995	2700 - 6500	47	1138	73	2.3	2	2835
PL10U15L15L	37	2835 SMD	PCB	4995	2700 - 6500	47	1418	73	2.9	2	2295
PL10U16L15L	44	2835 SMD	PCB	5990	2700 - 6500	47	1698	73	3.5	2	1970
PL10U17L15L	52	2835 SMD	PCB	6990	2700 - 6500	47	1978	73	4.0	2	1560
PL10U18L15L	60	2835 SMD	PCB	7985	2700 - 6500	47	2258	73	4.6	2	1560
PL10U19L15L	66	2835 SMD	PCB	8985	2700 - 6500	47	2538	73	5.2	2	1560
PL10U10L15L	75	2835 SMD	PCB	9985	2700 - 6500	47	2818	73	5.7	2	1255

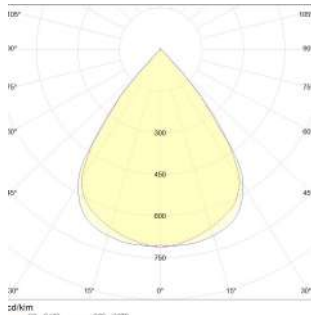
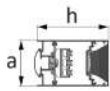

80° Light Beam

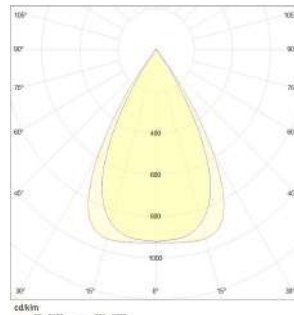

50° Light Beam

V / Hz 220 - 240 / 50 - 60

Options	Options
Dimmable electronic ballast or convertor. Emergency kit	Ballast électronique dimmable ou converteur. Kit d'urgence.
NOTE	NOTE
Given lumen values are net delivered luminaire output lumens.	Les valeurs de lumens sont les lumens de sortie nets du luminaire.
Given power values are total consumed AC power of the luminaire.	Les valeurs de puissance données sont la puissance AC totale consommée du luminaire.

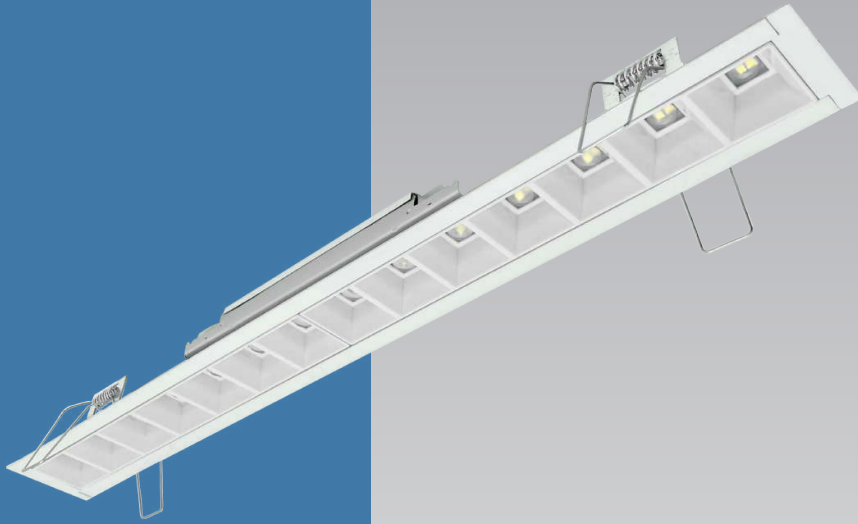

ELITE DAISY LINEAR RECESSED

LED

Recessed Lighting Fixtures With Lens

Luminaire Encastrés Avec Lentille

BODY

Anodized aluminum with satin finishing. Black and white color options with elegant design.

LENS

With 50° or 80° lens.

DIFFUSER

UV stabilized frosted diffuser.

CONVERTER

Compatible with ENEC standards.

LED

LED modules with 60.000 hours lifetime LUMILEDS / SAMSUNG / NICHIA brand LEDs.

CORPS

Corps en aluminium anodisé, satiné. Design élégant. Couleurs blanc, noir disponibles.

LENS

Avec lentille 50 ° ou 80 °.

DIFFUSEUR

Diffuseur givré. Anti UV.

CONVERTEUR

Convertisseur, conforme aux normes ENEC.

LED

Modules LED – Durée de vie 60.000 heures avec LED de marque LUMILEDS / SAMSUNG / NICHIA.

APPLICATION AREAS

Shopping Malls
Supermarkets
Offices
Meeting rooms
Stores
Hospitals
Schools
Corridors

DOMAINES D'UTILISATION

Centres Commerciaux
Supermarchés
Bureaux
Salles de Réunions
Magasins
Hopitaux
Ecoles
Couloirs

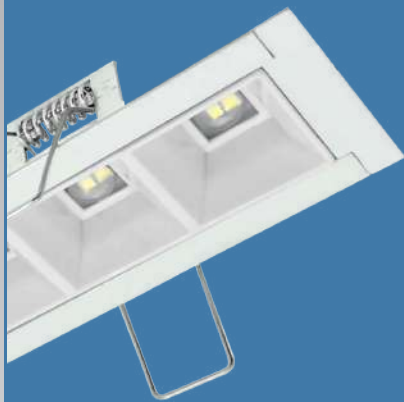

Color Options
Options de Couleur



LED Type / Type LED

Color Rendering Index / Indice de Rendu des Couleurs: (CRI): Ra>80

Code	Power Puissance (W)	LED Type Type De LED	LED Module Module LED	Lum. Flux Flux Lum. (lm)	Color Temperature Température De Couleur (K)	Dimensions (mm)			Weight Poids (kg)	Packing Quantity Colisage	Pcs./20" Container Pcs./20" Conteneur
						a	l	h			
PL10A11L15L	10	2835 SMD	PCB	1000	2700 - 6500	53	287	50	1.2	2	12690
PL10A12L15L	16	2835 SMD	PCB	2000	2700 - 6500	53	567	50	1.7	2	7824
PL10A13L15L	22	2835 SMD	PCB	2995	2700 - 6500	53	847	50	2.3	2	4230
PL10A14L15L	29	2835 SMD	PCB	3995	2700 - 6500	53	1127	50	2.9	2	3510
PL10A15L15L	37	2835 SMD	PCB	4995	2700 - 6500	53	1407	50	3.5	2	3423
PL10A16L15L	44	2835 SMD	PCB	5990	2700 - 6500	53	1687	50	4.1	2	2280
PL10A17L15L	52	2835 SMD	PCB	6990	2700 - 6500	53	1967	50	4.7	2	1878
PL10A18L15L	60	2835 SMD	PCB	7985	2700 - 6500	53	2247	50	5.3	2	1878
PL10A19L15L	66	2835 SMD	PCB	8985	2700 - 6500	53	2527	50	5.9	2	1500
PL10A10L15L	75	2835 SMD	PCB	9985	2700 - 6500	53	2807	50	6.5	2	1500

Visible frame width / Largeur de cadre visible: 63mm

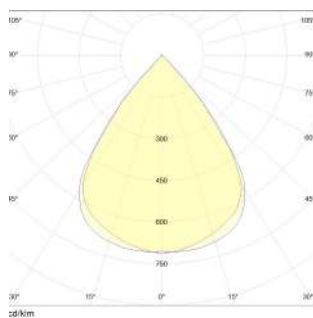
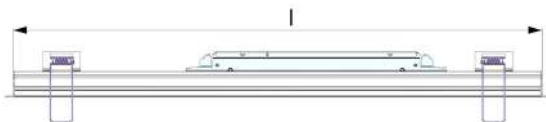
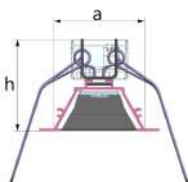

80° Light Beam

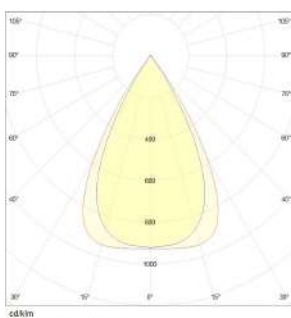

50° Light Beam



V / Hz | 220 - 240 / 50 - 60

Options	Options
Dimmable electronic ballast or convertor. Emergency kit	Ballast électronique dimmable ou converteur. Kit d'urgence.
NOTE	NOTE
Given lumen values are net delivered luminaire output lumens.	Les valeurs de lumens données sont les lumens de sortie nets du luminaire.
Given power values are total consumed AC power of the luminaire.	Les valeurs de puissance données sont la puissance AC totale consommée du luminaire.



ELITE DAISY MIX

LED

Suspended Lighting Fixtures With Lens

Luminaire Suspendus Avec Lentille

APPLICATION AREAS

Shopping Malls
Supermarkets
Offices
Meeting rooms
Stores
Hospitals
Schools
Corridors

DOMAINES D'UTILISATION

Centres Commerciaux
Supermarchés
Bureaux
Salles de Réunions
Magasins
Hopitaux
Ecoles
Couloirs

BODY

Anodized aluminum with satin finishing. Black and white color options with elegant design.

LENS

With 50° or 80° lens.

DIFFUSER

UV stabilized frosted diffuser.

CONVERTER

Compatible with ENEC standards.

LED

LED modules with 60.000 hours lifetime LUMILEDS / SAMSUNG / NICHIA brand LEDs.

SUSPENSION

Composed of 1mm steel wire rope and nickel-plated brass components. Suspension height is adjustable. Supplied with transparent electric cord and ceiling mounted electrical junction box with aesthetic design.

CORPS

Corps en aluminium anodisé, satiné. Design élégant. Couleurs blanc, noir disponibles.

LENS

Avec lentille 50° ou 80°.

DIFFUSEUR

Diffuseur givré. Anti UV.

CONVERTEUR

Convertisseur, conforme aux normes ENEC.

LED

Modules LED – Durée de vie 60.000 heures avec LED de marque LUMILEDS / SAMSUNG / NICHIA.

SYSTEME DE FIXATION

Composé d'un fil en acier de 1mm, de composants en laiton nickelés. Livré avec un cordon électrique transparent et une boîte de jonction électrique à fixer au plafond. Hauteur de fixation réglable.

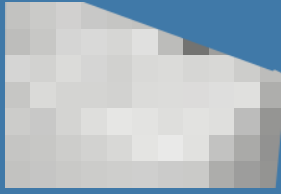

Color Options
Options de Couleur



LED Type / Type LED

Color Rendering Index / Indice de Rendu des Couleurs: (CRI): Ra>80

Code	Power Puissance (W)	LED Type Type De LED	LED Module Module LED	Lum. Flux Flux Lum. (lm)	Color Temperature Température De Couleur (K)	Dimensions (mm)			Weight Poids (kg)	Packing Quantity Colisage	Pcs./20" Container Pcs./20" Conteneur
						a	l	h			
PL10SM12L25CL	37	2835 SMD	PCB	3430	2700 - 6500	47	1140	73	2.3	2	2835
PL10SM13L25CL	46	2835 SMD	PCB	4145	2700 - 6500	47	1421	73	2.9	2	2295
PL10SM14L25CL	57	2835 SMD	PCB	4860	2700 - 6500	47	1700	73	3.5	2	1970
PL10SM15L25CL	67	2835 SMD	PCB	5575	2700 - 6500	47	1981	73	4.0	2	1560

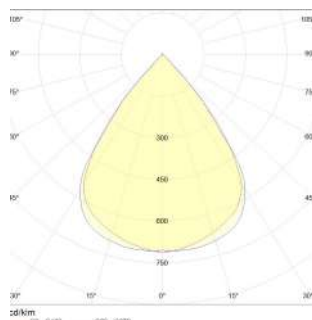
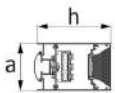

80° Light Beam

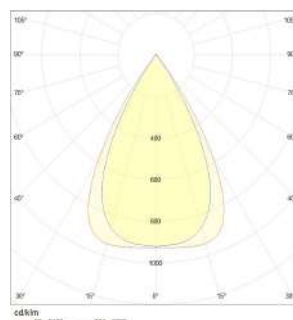

50° Light Beam

V / Hz 220 - 240 / 50 - 60

Options	Options
Dimmable electronic ballast or convertor. Emergency kit	Ballast électronique dimmable ou convertor. Kit d'urgence.
NOTE	NOTE
Given lumen values are net delivered luminaire output lumens.	Les valeurs de lumens données sont les lumens de sortie nets du luminaire.
Given power values are total consumed AC power of the luminaire.	Les valeurs de puissance données sont la puissance AC totale consommée du luminaire.

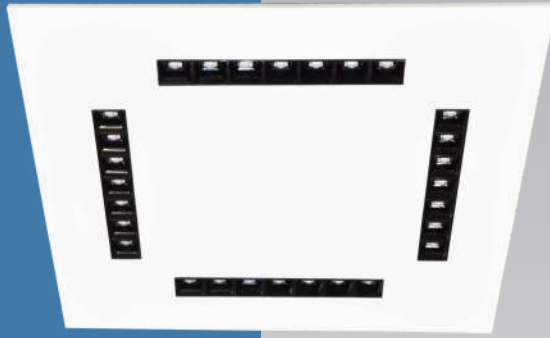

ELITE DAISY SURFACE

LED

Surface Mounted Lighting Fixtures With Lens

Luminaire Apparents Avec Lentille

APPLICATION AREAS

Offices
Meeting rooms
Stores
Hospitals
Schools
Corridors

DOMAINES D'UTILISATION

Bureaux
Salles de Réunion
Magasins
Hopitaux
Ecoles
Couloirs

BODY

Electrostatic powder coated sheetmetal.

LENS

With 50° or 80° lens.

REFLECTOR

Special reflector that provides homogeneous distribution together with the lenses.

CONVERTER

Long life, low power loss converter with constant current. Compatible with ENEC standards.

LED

LED modules with 60.000 hours lifetime LUMILEDS / SAMSUNG / NICHIA brand LEDs.

CORPS

Feuille de métal peinte électrostatiquement.

LENS

Avec lentille 50 ° ou 80 °.

RÉFLECTEUR

Réflecteur spécial qui assure une distribution homogène avec les lentilles.

CONVERTEUR

Convertisseur, conforme aux normes ENEC. Longue vie. Perte de puissance faible avec courant constant .

LED

Modules LED – Durée de vie 60.000 heures avec LED de marque LUMILEDS / SAMSUNG / NICHIA.

Color Options
Options de Couleur



LED Type / Type LED

Color Rendering Index / Indice de Rendu des Couleurs: (CRI): Ra>80

Code	Power Puissance (W)	LED Type Type De LED	LED Module Module LED	Lum. Flux Flux Lum. (lm)	Color Temperature Température De Couleur (K)	Dimensions (mm)			Weight Poids (kg)	Packing Quantity Colisage	Pcs./20" Container Pcs./20" Conteneur
						a	b	h			
PL10U21E15L	16	2835 SMD	PCB	2000	2700 - 6500	300	300	25	2.5	4	8000
PL10U22E15L	29	2835 SMD	PCB	3995	2700 - 6500	300	600	25	5.0	4	4200
PL10U24E15L	60	2835 SMD	PCB	7985	2700 - 6500	300	1200	25	11.0	4	2200
PL10U41E15L	29	2835 SMD	PCB	3995	2700 - 6500	600	600	25	5.5	4	2740

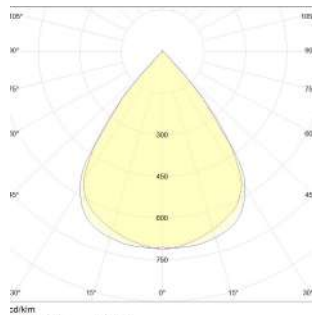
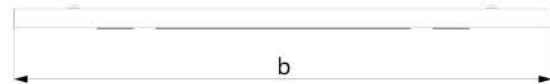
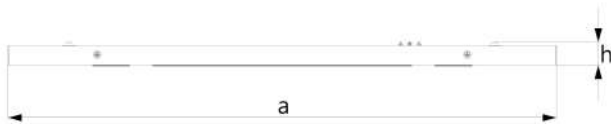

80° Light Beam

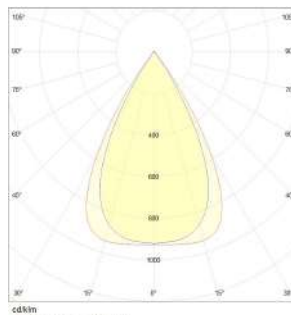

50° Light Beam

V / Hz 220 - 240 / 50 - 60

Options	Options
Dimmable electronic ballast or convertor.	Ballast électronique dimmable ou converteur.
Emergency kit	Kit d'urgence.

NOTE	NOTE
Given lumen values are net delivered luminaire output lumens.	Les valeurs de lumens données sont les lumens de sortie nets du luminaire.
Given power values are total consumed AC power of the luminaire.	Les valeurs de puissance données sont la puissance AC totale consommée du luminaire.

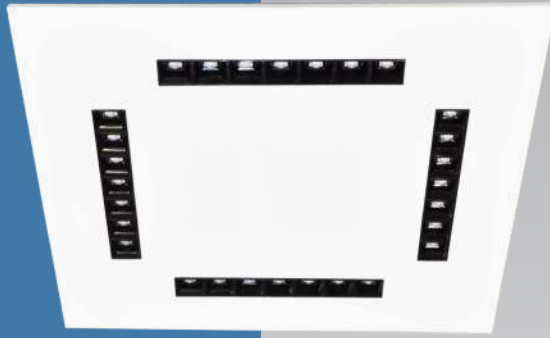

ELITE DAISY RECESSED T BAR CEILING

LED

Recessed Lighting Fixtures With Lens

Luminaire Encastrés Avec Lentille

APPLICATION AREAS

Offices
Meeting rooms
Stores
Hospitals
Schools
Corridors

DOMAINES D'UTILISATION

Bureaux
Salles de Réunion
Magasins
Hopitaux
Ecoles
Couloirs

BODY

Electrostatic powder coated sheetmetal.

LENS

With 50° or 80° lens.

REFLECTOR

Special reflector that provides homogeneous distribution together with the lenses.

CONVERTER

Long life, low power loss converter with constant current. Compatible with ENEC standards.

LED

LED modules with 60.000 hours lifetime LUMILEDS / SAMSUNG / NICHIA brand LEDs.

CORPS

Feuille de métal peinte électrostatiquement.

LENS

Avec lentille 50 ° ou 80 °.

RÉFLECTEUR

Réflecteur spécial qui assure une distribution homogène avec les lentilles.

CONVERTEUR

Convertisseur, conforme aux normes ENEC. Longue vie. Perte de puissance faible avec courant constant .

LED

Modules LED – Durée de vie 60.000 heures avec LED de marque LUMILEDS / SAMSUNG / NICHIA.

Ceiling Mounting System
Système de Montage au Plafond

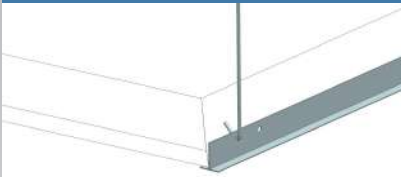

Color Options
Options de Couleur



LED Type / Type LED

Color Rendering Index / Indice de Rendu des Couleurs: (CRI): Ra > 80

Code	Power Puissance (W)	LED Type Type De LED	LED Module Module LED	Lum. Flux Flux Lum. (lm)	Color Temperature Température De Couleur (K)	Dimensions (mm)					Weight Poids (kg)	Packing Quantity Colisage	Pcs./20" Container Pcs./20" Conteneur
						a1	a2	b1	b2	h			
PL10A21E15L	16	2835 SMD	PCB	2000	2700 - 6500	295	275	295	275	23	2.5	4	8000
PL10A22E15L	29	2835 SMD	PCB	3995	2700 - 6500	295	275	595	575	23	5.0	4	4200
PL10A24E15L	60	2835 SMD	PCB	7985	2700 - 6500	295	275	1195	1175	23	11.0	4	2200
PL10A41E15L	29	2835 SMD	PCB	3995	2700 - 6500	595	575	595	575	23	5.5	4	2740

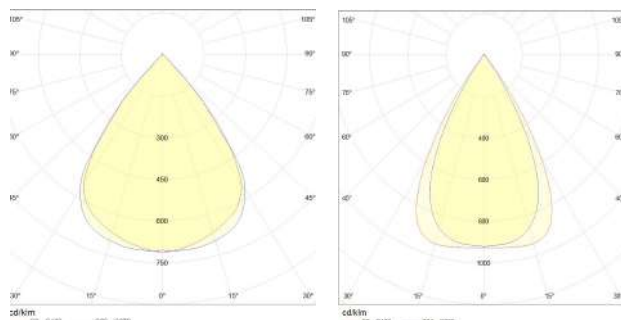
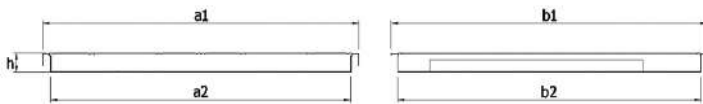

80° Light Beam

50° Light Beam

V / Hz 220 - 240 / 50 - 60

Options	Options
Dimmable electronic ballast or convertor.	Ballast électronique dimmable ou converteur.
Emergency kit	Kit d'urgence.

NOTE	NOTE
Given lumen values are net delivered luminaire output lumens.	Les valeurs de lumens données sont les lumens de sortie nets du luminaire.
Given power values are total consumed AC power of the luminaire.	Les valeurs de puissance données sont la puissance AC totale consommée du luminaire.

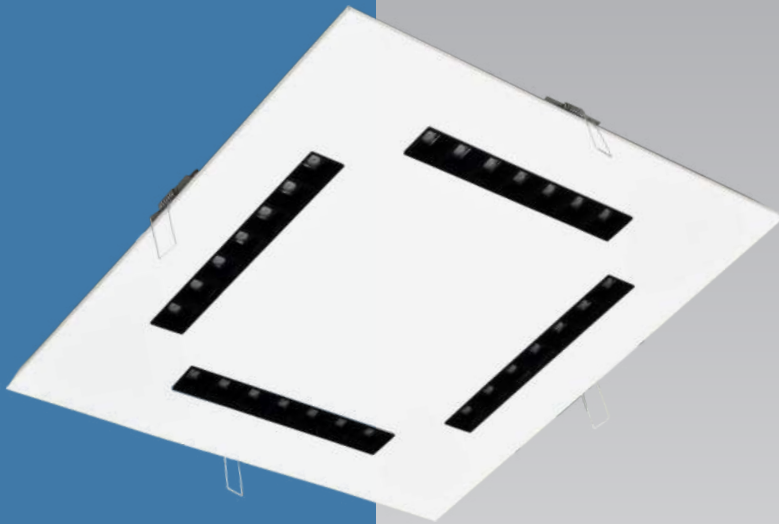

ELITE DAISY RECESSED GYPSUM CEILING

LED

Recessed Lighting Fixtures With Lens

Luminaire Encastrés Avec Lentille

APPLICATION AREAS

Offices
Meeting rooms
Stores
Hospitals
Schools
Corridors

DOMAINES D'UTILISATION

Bureaux
Salles de Réunion
Magasins
Hopitaux
Ecoles
Couloirs

BODY

Electrostatic powder coated sheetmetal.

LENS

With 50° or 80° lens.

REFLECTOR

Special reflector that provides homogeneous distribution together with the lenses.

CONVERTER

Long life, low power loss converter with constant current. Compatible with ENEC standards.

LED

LED modules with 60.000 hours lifetime LUMILEDS / SAMSUNG / NICHIA brand LEDs.

CORPS

Feuille de métal peinte électrostatiquement.

LENS

Avec lentille 50 ° ou 80 °.

RÉFLECTEUR

Réflecteur spécial qui assure une distribution homogène avec les lentilles.

CONVERTEUR

Convertisseur, conforme aux normes ENEC. Longue vie. Perte de puissance faible avec courant constant .

LED

Modules LED – Durée de vie 60.000 heures avec LED de marque LUMILEDS / SAMSUNG / NICHIA.

Ceiling Mounting System
Système de Montage au Plafond

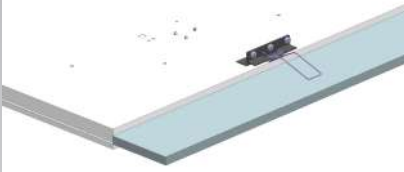

Color Options
Options de Couleur



LED Type / Type LED

Color Rendering Index / Indice de Rendu des Couleurs: (CRI): Ra>80

Code	Power Puissance (W)	LED Type Type De LED	LED Module Module LED	Lum. Flux Flux Lum. (lm)	Color Temperature Température De Couleur (K)	Dimensions (mm)					Weight Poids (kg)	Packing Quantity Colisage	Pcs./20" Container Pcs./20" Conteneur
						a1	a2	b1	b2	h			
PL10AY21E15L	16	2835 SMD	PCB	2000	2700 - 6500	295	275	295	275	23	2.5	4	8000
PL10AY22E15L	29	2835 SMD	PCB	3995	2700 - 6500	295	275	595	575	23	5.0	4	4200
PL10AY24E15L	60	2835 SMD	PCB	7985	2700 - 6500	295	275	1195	1175	23	11.0	4	2200
PL10AY41E15L	29	2835 SMD	PCB	3995	2700 - 6500	595	575	595	575	23	5.5	4	2740

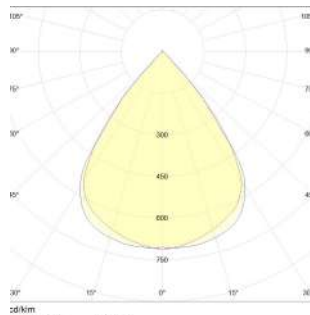
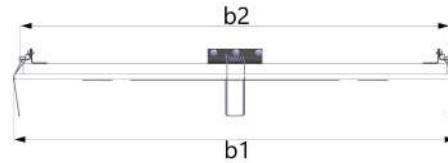
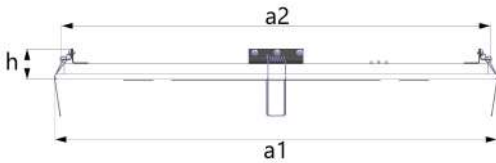

80° Light Beam

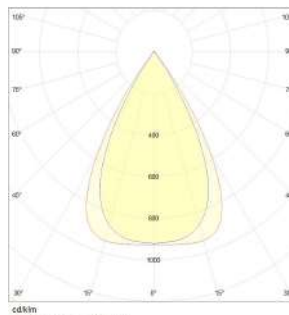

50° Light Beam

V / Hz 220 - 240 / 50 - 60

Options	Options
Dimmable electronic ballast or convertor. Emergency kit	Ballast électronique dimmable ou converteur. Kit d'urgence.
NOTE	NOTE
Given lumen values are net delivered luminaire output lumens.	Les valeurs de lumens données sont les lumens de sortie nets du luminaire.
Given power values are total consumed AC power of the luminaire.	Les valeurs de puissance données sont la puissance AC totale consommée du luminaire.





PRIZMA



PRIZMA

LED

Suspended 2X Lighting Fixtures With Frosted Diffuser

Luminaire suspendu 2X Avec Diffuseur Givré

BODY

Anodized aluminum with satin finishing. Black, white and silver color options with thin (32mm) elegant design.

DIFFUSER

UV stabilized clear prismatic diffuser.

CONVERTER

Long life, low power loss converter with constant current. Compatible with ENEC standards.

LED

LED modules with 60.000 hours lifetime LUMILEDS / SAMSUNG / NICHIA brand LEDs.

SUSPENSION

Composed of 1mm steel wire rope and nickel-plated brass components. Suspension height is adjustable. Supplied with transparent electric cord and ceiling mounted electrical junction box with aesthetic design.

CORPS

Corps en aluminium anodisé, satiné. Design élégant. Couleurs blanc, argent et noir disponibles. Epaisseur 32 mm.

DIFFUSEUR

Diffuseur prismatique transparent stabilisé aux UV.

CONVERTEUR

Convertisseur, conforme aux normes ENEC. Longue vie. Perte de puissance faible avec courant constant.

LED

Modules LED – Durée de vie 60.000 heures avec LED de marque LUMILEDS / SAMSUNG / NICHIA.

SYSTEME DE FIXATION

Composé d'un fil en acier de 1mm, de composants en laiton nickelés. Livré avec un cordon électrique transparent et une boîte de jonction électrique à fixer au plafond. Hauteur de fixation réglable.

APPLICATION AREAS

Offices
Meeting rooms
Stores
Hospitals
Schools
Corridors

DOMAINES D'UTILISATION

Bureaux
Salles de Réunion
Magasins
Hopitaux
Ecoles
Couloirs

Color Options
Options de Couleur



LED Type / Type LED

Color Rendering Index / Indice de Rendu des Couleurs: (CRI): Ra>80

Code	Power Puissance (W)	LED Type Type De LED	LED Module Module LED	Lum. Flux Flux Lum. (lm)	Color Temperature Température De Couleur (K)	Dimensions (mm)			Weight Poids (kg)	Packing Quantity Colisage	Pcs./20" Container Pcs./20" Conteneur
						a	b	h			
PL4S22L15C	26	2835 SMD	PCB	3570	2700 - 6500	223	620	32	2.6	2	2630
PL4S22L25C	41	2835 SMD	PCB	5360	2700 - 6500	223	620	32	2.6	2	2630
PL4S23L15C	39	2835 SMD	PCB	5360	2700 - 6500	223	900	32	3.3	2	1860
PL4S23L25C	61	2835 SMD	PCB	8040	2700 - 6500	223	900	32	3.3	2	1860
PL4S24L15C	53	2835 SMD	PCB	7145	2700 - 6500	223	1180	32	4.0	2	1440
PL4S24L25C	80	2835 SMD	PCB	10720	2700 - 6500	223	1180	32	4.0	2	1440
PL4S25L15C	66	2835 SMD	PCB	8930	2700 - 6500	223	1460	32	4.8	2	1170
PL4S25L25C	100	2835 SMD	PCB	13395	2700 - 6500	223	1460	32	4.8	2	1170

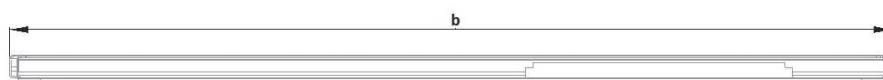
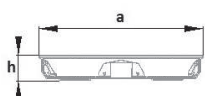

V / Hz 220 - 240 / 50 - 60

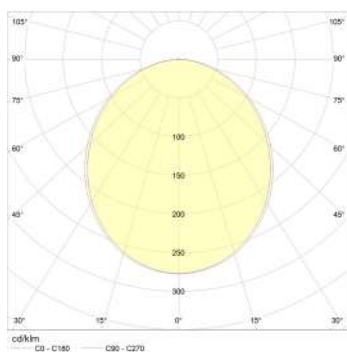

Options	Options
Dimmable electronic ballast or convertor. Emergency kit	Ballast électronique dimmable ou converteur. Kit d'urgence.
NOTE	NOTE
Given lumen values are net delivered luminaire output lumens.	Les valeurs de lumens données sont les lumens de sortie nets du luminaire.
Given power values are total consumed AC power of the luminaire.	Les valeurs de puissance données sont la puissance AC totale consommée du luminaire.

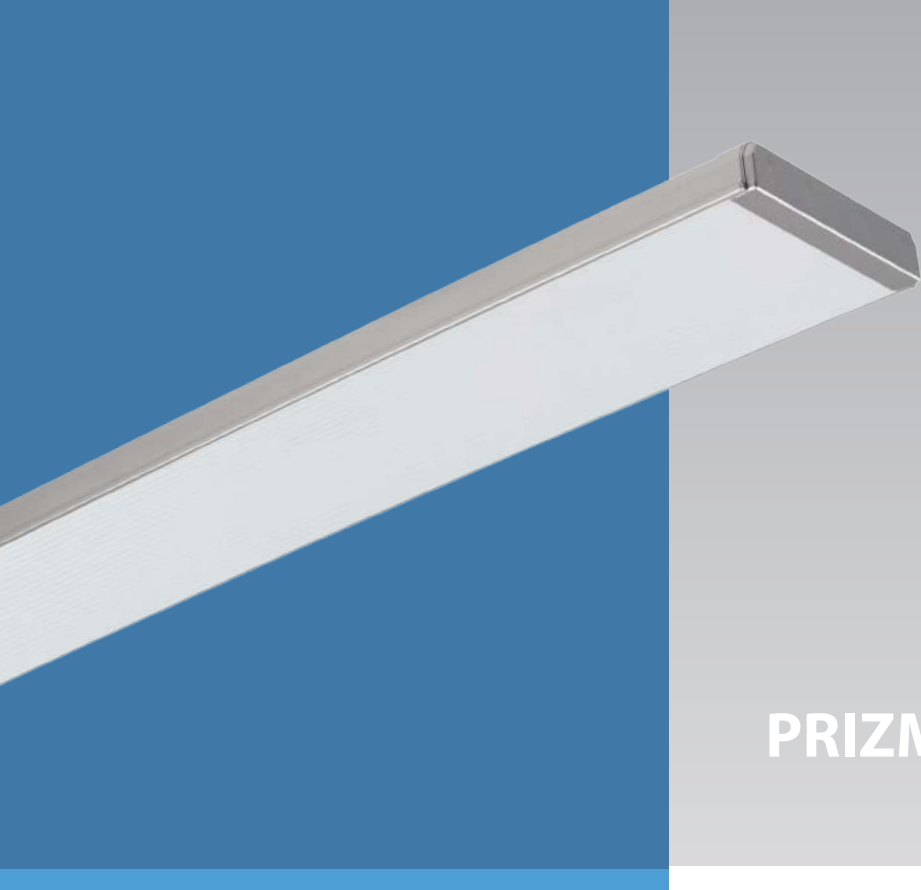

PRIZMA

LED

Surface Mounted 2X Lighting Fixtures With Frosted Diffuser

Luminaire Apparents 2X Avec Diffuseur Givré

BODY

Anodized aluminum with satin finishing. Black, white and silver color options with thin (32mm) elegant design.

DIFFUSER

UV stabilized clear prismatic diffuser.

CONVERTER

Long life, low power loss converter with constant current. Compatible with ENEC standards.

LED

LED modules with 60.000 hours lifetime LUMILEDS / SAMSUNG / NICHIA brand LEDs.

CORPS

Corps en aluminium anodisé, satiné. Design élégant. Couleurs blanc, argent et noir disponibles. Epaisseur 32 mm.

DIFFUSEUR

Diffuseur prismatique transparent stabilisé aux UV.

CONVERTEUR

Convertisseur, conforme aux normes ENEC. Longue vie. Perte de puissance faible avec courant constant.

LED

Modules LED – Durée de vie 60.000 heures avec LED de marque LUMILEDS / SAMSUNG / NICHIA.

APPLICATION AREAS

Offices
Meeting rooms
Stores
Hospitals
Schools
Corridors

DOMAINES D'UTILISATION

Bureaux
Salles de Réunion
Magasins
Hopitaux
Ecoles
Couloirs

Color Options
Options de Couleur



LED Type / Type LED

Color Rendering Index / Indice de Rendu des Couleurs: (CRI): Ra>80

Code	Power Puissance (W)	LED Type Type De LED	LED Module Module LED	Lum. Flux Flux Lum. (lm)	Color Temperature Température De Couleur (K)	Dimensions (mm)			Weight Poids (kg)	Packing Quantity Colisage	Pcs./20" Container Pcs./20" Conteneur
						a	b	h			
PL4U22L15C	26	2835 SMD	PCB	3570	2700 - 6500	223	620	32	2.6	2	2630
PL4U22L25C	41	2835 SMD	PCB	5360	2700 - 6500	223	620	32	2.6	2	2630
PL4U23L15C	39	2835 SMD	PCB	5360	2700 - 6500	223	900	32	3.3	2	1860
PL4U23L25C	61	2835 SMD	PCB	8040	2700 - 6500	223	900	32	3.3	2	1860
PL4U24L15C	53	2835 SMD	PCB	7145	2700 - 6500	223	1180	32	4.0	2	1440
PL4U24L25C	80	2835 SMD	PCB	10720	2700 - 6500	223	1180	32	4.0	2	1440
PL4U25L15C	66	2835 SMD	PCB	8930	2700 - 6500	223	1460	32	4.8	2	1170
PL4U25L25C	100	2835 SMD	PCB	13395	2700 - 6500	223	1460	32	4.8	2	1170

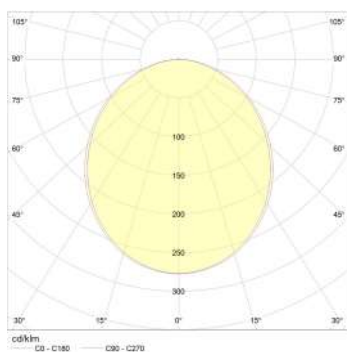
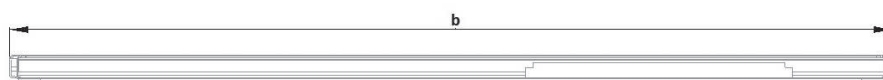
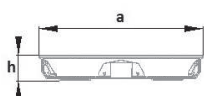

V / Hz 220 - 240 / 50 - 60

Options	Options
Dimmable electronic ballast or convertor. Emergency kit	Ballast électronique dimmable ou converteur. Kit d'urgence.
NOTE	NOTE
Given lumen values are net delivered luminaire output lumens.	Les valeurs de lumens données sont les lumens de sortie nets du luminaire.
Given power values are total consumed AC power of the luminaire.	Les valeurs de puissance données sont la puissance AC totale consommée du luminaire.

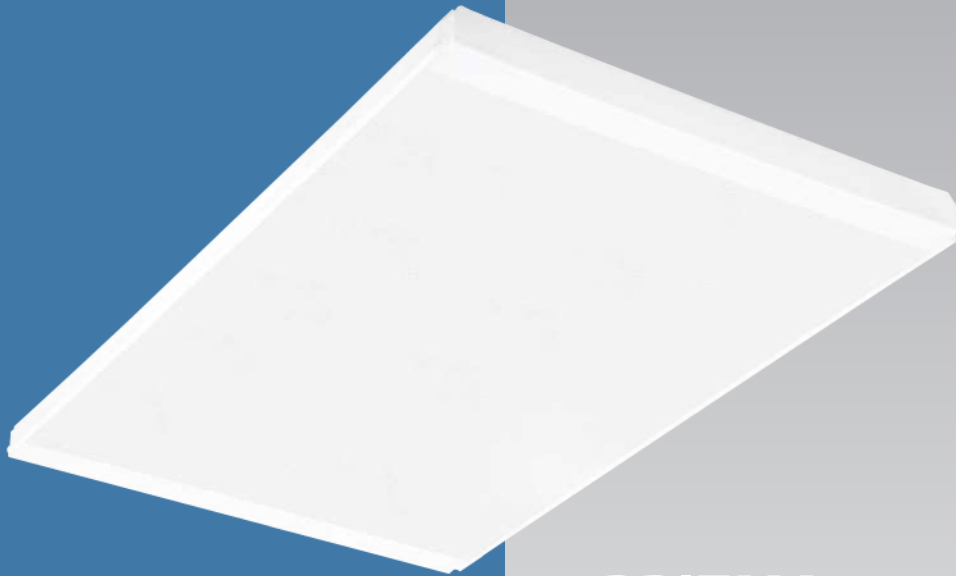

PRIZMA

LED

Surface Mounted 4X Lighting Fixtures With Frosted Diffuser

Luminaire Apparents 4X Avec Diffuseur Givré

APPLICATION AREAS

Offices
Meeting rooms
Stores
Hospitals
Schools
Corridors

DOMAINES D'UTILISATION

Bureaux
Salles de Réunion
Magasins
Hopitaux
Ecoles
Couloirs

BODY

Anodized aluminum with satin finishing. Black, white and silver color options with thin (32mm) elegant design.

DIFFUSER

UV stabilized clear prismatic diffuser.

CONVERTER

Long life, low power loss converter with constant current. Compatible with ENEC standards.

LED

LED modules with 60.000 hours lifetime LUMILEDS / SAMSUNG / NICHIA brand LEDs.

CORPS

Corps en aluminium anodisé, satiné. Design élégant. Couleurs blanc, argent et noir disponibles. Epaisseur 32 mm.

DIFFUSEUR

Diffuseur prismatique transparent stabilisé aux UV.

CONVERTEUR

Convertisseur, conforme aux normes ENEC. Longue vie. Perte de puissance faible avec courant constant.

LED

Modules LED – Durée de vie 60.000 heures avec LED de marque LUMILEDS / SAMSUNG / NICHIA.

Color Options
Options de Couleur



LED Type / Type LED

Color Rendering Index / Indice de Rendu des Couleurs: (CRI): Ra>80

Code	Power Puissance (W)	LED Type Type De LED	LED Module Module LED	Lum. Flux Flux Lum. (lm)	Color Temperature Température De Couleur (K)	Dimensions (mm)			Weight Poids (kg)	Packing Quantity Colisage	Pcs./20" Container Pcs./20" Conteneur
						a	b	h			
PL4U42L15C	53	2835 SMD	PCB	7145	2700 - 6500	389	620	32	3.2	2	1680
PL4U43L15C	79	2835 SMD	PCB	10720	2700 - 6500	389	900	32	4.5	2	1180
PL4U44L15C	105	2835 SMD	PCB	14290	2700 - 6500	389	1180	32	5.9	2	910
PL4U45L15C	132	2835 SMD	PCB	17860	2700 - 6500	389	1460	32	7.2	2	745

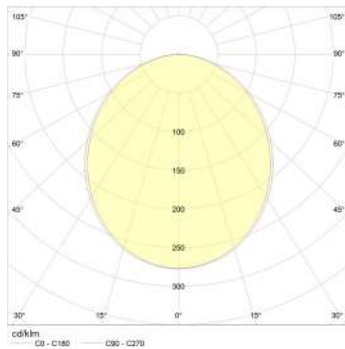
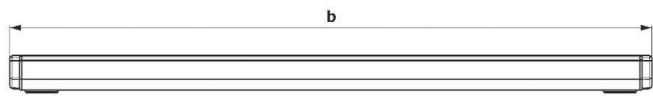
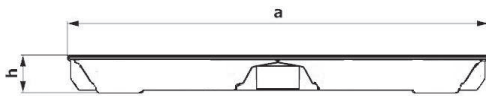

V / Hz 220 - 240 / 50 - 60

Options	Options
Dimmable electronic ballast or converter. Emergency kit	Ballast électronique dimmable ou converteur. Kit d'urgence.
NOTE	NOTE
Given lumen values are net delivered luminaire output lumens.	Les valeurs de lumens données sont les lumens de sortie nets du luminaire.
Given power values are total consumed AC power of the luminaire.	Les valeurs de puissance données sont la puissance AC totale consommée du luminaire.





FAST LINE



FAST LINE

LED

Suspended Lighting Fixtures With Frosted Diffuser

Luminaire suspendus Avec Diffuseur Givré

APPLICATION AREAS

Shopping Malls
Supermarkets
Offices
Meeting rooms
Stores
Hospitals
Schools
Corridors

DOMAINES D'UTILISATION

Centres Commerciaux
Supermarchés
Bureaux
Salles de Réunions
Magasins
Hopitaux
Ecoles
Couloirs

BODY

Anodized aluminum with satin finishing. Black and white color options with elegant design.

DIFFUSER

UV stabilized frosted diffuser.

CONVERTER

Long life, low power loss converter with constant current. Compatible with ENEC standards.

LED

LED modules with 60.000 hours lifetime LUMILEDS / SAMSUNG / NICHIA brand LEDs.

SUSPENSION

Composed of 1mm steel wire rope and nickel-plated brass components. Suspension height is adjustable. Supplied with transparent electric cord and ceiling mounted electrical junction box with aesthetic design

CORPS

Corps en aluminium anodisé, satiné. Design élégant. Couleurs blanc, noir disponibles.

DIFFUSEUR

Diffuseur givré. Anti UV.

CONVERTEUR

Convertisseur, conforme aux normes ENEC. Longue vie. Perte de puissance faible avec courant constant.

LED

Modules LED – Durée de vie 60.000 heures avec LED de marque LUMILEDS / SAMSUNG / NICHIA.

SYSTEME DE FIXATION

Composé d'un fil en acier de 1mm, de composants en laiton nickelés. Livré avec un cordon électrique transparent et une boîte de jonction électrique à fixer au plafond. Hauteur de fixation réglable.

Color Options
Options de Couleur



LED Type / Type LED

Color Rendering Index / Indice de Rendu des Couleurs: (CRI): Ra>80

Code	Power Puissance (W)	LED Type Type De LED	LED Module Module LED	Lum. Flux Flux Lum. (lm)	Color Temperature Température De Couleur (K)	Dimensions (mm)			Weight Poids (kg)	Packing Quantity Colisage	Pcs./20" Container Pcs./20" Conteneur
						a	l	h			
PL23S12L15C	14	2835 SMD	PCB	1120	2700 - 6500	45	570	65	0.7	4	8000
PL23S12L25C	21	2835 SMD	PCB	1690	2700 - 6500	45	570	65	0.7	4	8000
PL23S13L15C	21	2835 SMD	PCB	1685	2700 - 6500	45	850	65	1.1	4	8000
PL23S13L25C	30	2835 SMD	PCB	2535	2700 - 6500	45	850	65	1.1	4	8000
PL23S14L15C	26	2835 SMD	PCB	2245	2700 - 6500	45	1130	65	1.4	4	5650
PL23S14L25C	41	2835 SMD	PCB	3375	2700 - 6500	45	1130	65	1.4	4	5650
PL23S15L15C	33	2835 SMD	PCB	2805	2700 - 6500	45	1412	65	1.8	4	4570
PL23S15L25C	51	2835 SMD	PCB	4220	2700 - 6500	45	1412	65	1.8	4	4570
PL23S16L15C	39	2835 SMD	PCB	3365	2700 - 6500	45	1693	65	2.1	4	4100
PL23S16L25C	61	2835 SMD	PCB	5065	2700 - 6500	45	1693	65	2.1	4	4100
PL23S17L15C	47	2835 SMD	PCB	3925	2700 - 6500	45	1973	65	2.5	4	3550
PL23S17L25C	70	2835 SMD	PCB	5905	2700 - 6500	45	1973	65	2.5	4	3550
PL23S18L15C	53	2835 SMD	PCB	4485	2700 - 6500	45	2254	65	2.8	4	3100
PL23S19L15C	60	2835 SMD	PCB	5045	2700 - 6500	45	2534	65	3.2	4	2650
PL23S10L15C	66	2835 SMD	PCB	5605	2700 - 6500	45	2815	65	3.5	4	2450

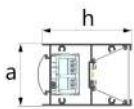

V / Hz 220 - 240 / 50 - 60

Options	Options
Dimmable electronic ballast or convertor. Emergency kit	Ballast électronique dimmable ou converteur. Kit d'urgence.

NOTE	NOTE
Given lumen values are net delivered luminaire output lumens.	Les valeurs de lumens données sont les lumens de sortie nets du luminaire.
Given power values are total consumed AC power of the luminaire.	Les valeurs de puissance données sont la puissance AC totale consommée du luminaire.

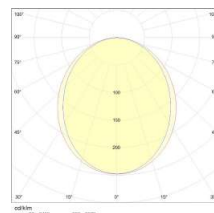

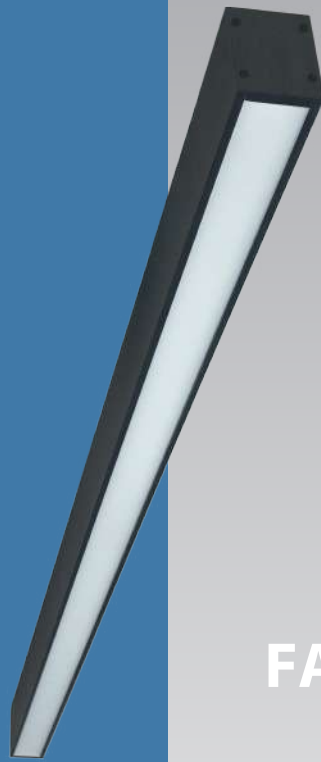

FAST LINE

LED

Surface Mounted Lighting Fixtures With Frosted Diffuser Luminaire Apparents Avec Diffuseur Givré

APPLICATION AREAS

Shopping Malls
Supermarkets
Offices
Meeting rooms
Stores
Hospitals
Schools
Corridors

DOMAINES D'UTILISATION

Centres Commerciaux
Supermarchés
Bureaux
Salles de Réunions
Magasins
Hopitaux
Ecoles
Couloirs

BODY

Anodized aluminum with satin finishing. Black and white color options with elegant design.

DIFFUSER

UV stabilized frosted diffuser.

CONVERTER

Long life, low power loss converter with constant current. Compatible with ENEC standards.

LED

LED modules with 60.000 hours lifetime LUMILEDS / SAMSUNG / NICHIA brand LEDs.

CORPS

Corps en aluminium anodisé, satiné. Design élégant. Couleurs blanc, noir disponibles.

DIFFUSEUR

Diffuseur givré. Anti UV.

CONVERTEUR

Convertisseur, conforme aux normes ENEC. Longue vie. Perte de puissance faible avec courant constant.

LED

Modules LED – Durée de vie 60.000 heures avec LED de marque LUMILEDS / SAMSUNG / NICHIA.

Color Options
Options de Couleur



LED Type / Type LED

Color Rendering Index / Indice de Rendu des Couleurs: (CRI): Ra>80

Code	Power Puissance (W)	LED Type Type De LED	LED Module Module LED	Lum. Flux Flux Lum. (lm)	Color Temperature Température De Couleur (K)	Dimensions (mm)			Weight Poids (kg)	Packing Quantity Colisage	Pcs./20" Container Pcs./20" Conteneur
						a	l	h			
PL23U12L15C	14	2835 SMD	PCB	1120	2700 - 6500	45	570	65	0.7	4	8000
PL23U12L25C	21	2835 SMD	PCB	1690	2700 - 6500	45	570	65	0.7	4	8000
PL23U13L15C	21	2835 SMD	PCB	1685	2700 - 6500	45	850	65	1.1	4	8000
PL23U13L25C	30	2835 SMD	PCB	2535	2700 - 6500	45	850	65	1.1	4	8000
PL23U14L15C	26	2835 SMD	PCB	2245	2700 - 6500	45	1130	65	1.4	4	5650
PL23U14L25C	41	2835 SMD	PCB	3375	2700 - 6500	45	1130	65	1.4	4	5650
PL23U15L15C	33	2835 SMD	PCB	2805	2700 - 6500	45	1412	65	1.8	4	4570
PL23U15L25C	51	2835 SMD	PCB	4220	2700 - 6500	45	1412	65	1.8	4	4570
PL23U16L15C	39	2835 SMD	PCB	3365	2700 - 6500	45	1693	65	2.1	4	4100
PL23U16L25C	61	2835 SMD	PCB	5065	2700 - 6500	45	1693	65	2.1	4	4100
PL23U17L15C	47	2835 SMD	PCB	3925	2700 - 6500	45	1973	65	2.5	4	3550
PL23U17L25C	70	2835 SMD	PCB	5905	2700 - 6500	45	1973	65	2.5	4	3550
PL23U18L15C	53	2835 SMD	PCB	4485	2700 - 6500	45	2254	65	2.8	4	3100
PL23U19L15C	60	2835 SMD	PCB	5045	2700 - 6500	45	2534	65	3.2	4	2650
PL23U10L15C	66	2835 SMD	PCB	5605	2700 - 6500	45	2815	65	3.5	4	2450

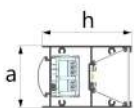

V / Hz 220 - 240 / 50 - 60

Options	Options
Dimmable electronic ballast or convertor. Emergency kit	Ballast électronique dimmable ou convertor. Kit d'urgence.

NOTE	NOTE
Given lumen values are net delivered luminaire output lumens.	Les valeurs de lumens données sont les lumens de sortie nets du luminaire.
Given power values are total consumed AC power of the luminaire.	Les valeurs de puissance données sont la puissance AC totale consommée du luminaire.

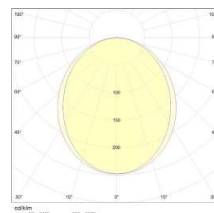





VEGA



KARE VEGA

LED

Suspended Lighting Fixtures With Frosted Diffuser

Luminaire Suspendus Avec Diffuseur Givré

APPLICATION AREAS

Shopping Malls
Supermarkets
Offices
Meeting rooms
Stores
Hospitals
Schools
Corridors

DOMAINES D'UTILISATION

Centres Commerciaux
Supermarchés
Bureaux
Salles de Réunions
Magasins
Hopitaux
Ecoles
Couloirs

BODY

Anodized aluminum with satin finishing. Black and white color options with elegant design.

DIFFUSER

UV stabilized frosted diffuser.

CONVERTER

Long life, low power loss converter with constant current. Compatible with ENEC standards.

LED

LED modules with 60.000 hours lifetime LUMILEDS / SAMSUNG / NICHIA brand LEDs.

SUSPENSION

Composed of 1mm steel wire rope and nickel-plated brass components. Suspension height is adjustable. Supplied with transparent electric cord and ceiling mounted electrical junction box with aesthetic design

CORPS

Corps en aluminium anodisé, satiné. Design élégant. Couleurs blanc, noir disponibles.

DIFFUSEUR

Diffuseur givré. Anti UV.

CONVERTEUR

Convertisseur, conforme aux normes ENEC. Longue vie. Perte de puissance faible avec courant constant.

LED

Modules LED – Durée de vie 60.000 heures avec LED de marque LUMILEDS / SAMSUNG / NICHIA.

SYSTEME DE FIXATION

Composé d'un fil en acier de 1mm, de composants en laiton nickelés. Livré avec un cordon électrique transparent et une boîte de jonction électrique à fixer au plafond. Hauteur de fixation réglable.

Color Options
Options de Couleur



LED Type / Type LED

Color Rendering Index / Indice de Rendu des Couleurs: (CRI): Ra>80

Code	Power Puissance (W)	LED Type Type De LED	LED Module Module LED	Lum. Flux Flux Lum. (lm)	Color Temperature Température De Couleur (K)	Dimensions (mm)			Weight Poids (kg)	Packing Quantity Colisage	Pcs./20" Container Pcs./20" Conteneur
						a	b	h			
PL7SK22L15C	53	2835 SMD	PCB	5170	2700 - 6500	632	632	90	5.5	1	415
PL7SK33L15C	79	2835 SMD	PCB	7755	2700 - 6500	912	912	90	8.1	1	210
PL7SK44L15C	105	2835 SMD	PCB	10340	2700 - 6500	1192	1192	90	10.2	1	125
PL7SK55L15C	132	2835 SMD	PCB	12920	2700 - 6500	1473	1473	90	13.3	1	85
PL7SK66L15C	158	2835 SMD	PCB	15505	2700 - 6500	1752	1752	90	15.6	1	60
PL7SK88L15C	205	2835 SMD	PCB	20675	2700 - 6500	2314	2314	90	17.9	1	35
PL7SK23L15C	66	2835 SMD	PCB	6460	2700 - 6500	632	912	90	6.8	1	295
PL7SK24L15C	79	2835 SMD	PCB	7755	2700 - 6500	632	1192	90	7.9	1	230
PL7SK34L15C	92	2835 SMD	PCB	9050	2700 - 6500	912	1192	90	9.2	1	160
PL7SK35L15C	105	2835 SMD	PCB	10340	2700 - 6500	912	1473	90	10.2	1	130

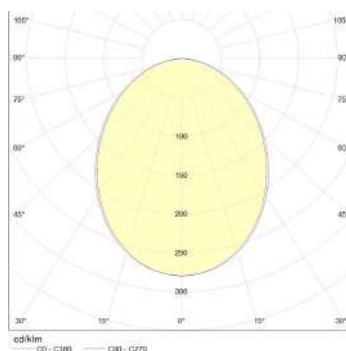
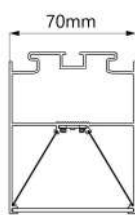
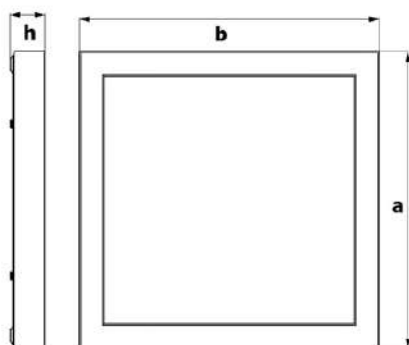

V / Hz 220 - 240 / 50 - 60

Options	Options
Dimmable electronic ballast or convertor. Emergency kit	Ballast électronique dimmable ou convertor. Kit d'urgence.
NOTE	NOTE
Given lumen values are net delivered luminaire output lumens.	Les valeurs de lumens données sont les lumens de sortie nets du luminaire.
Given power values are total consumed AC power of the luminaire.	Les valeurs de puissance données sont la puissance AC totale consommée du luminaire.

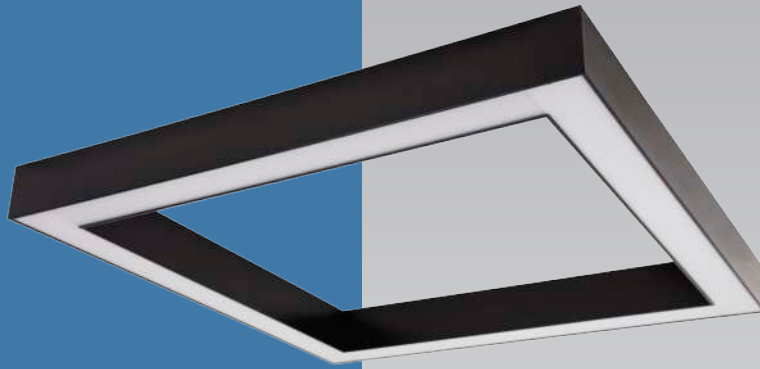

KARE VEGA

LED

Surface Mounted Lighting Fixtures With Frosted Diffuser

Luminaire Apparents Avec Diffuseur Givré

APPLICATION AREAS

Shopping Malls
Supermarkets
Offices
Meeting rooms
Stores
Hospitals
Schools
Corridors

DOMAINES D'UTILISATION

Centres Commerciaux
Supermarchés
Bureaux
Salles de Réunions
Magasins
Hopitaux
Ecoles
Couloirs

BODY

Anodized aluminum with satin finishing. Black and white color options with elegant design.

DIFFUSER

UV stabilized frosted diffuser.

CONVERTER

Long life, low power loss converter with constant current. Compatible with ENEC standards.

LED

LED modules with 60.000 hours lifetime LUMILEDS / SAMSUNG / NICHIA brand LEDs.

CORPS

Corps en aluminium anodisé, satiné. Design élégant. Couleurs blanc, noir disponibles.

DIFFUSEUR

Diffuseur givré. Anti UV.

CONVERTEUR

Convertisseur, conforme aux normes ENEC. Longue vie. Perte de puissance faible avec courant constant.

LED

Modules LED – Durée de vie 60.000 heures avec LED de marque LUMILEDS / SAMSUNG / NICHIA.

Color Options
Options de Couleur



LED Type / Type LED

Color Rendering Index / Indice de Rendu des Couleurs: (CRI): Ra > 80

Code	Power Puissance (W)	LED Type Type De LED	LED Module Module LED	Lum. Flux Flux Lum. (lm)	Color Temperature Température De Couleur (K)	Dimensions (mm)			Weight Poids (kg)	Packing Quantity Colisage	Pcs./20" Container Pcs./20" Conteneur
						a	b	h			
PL7UK22L15C	53	2835 SMD	PCB	5170	2700 - 6500	632	632	90	5.5	1	415
PL7UK33L15C	79	2835 SMD	PCB	7755	2700 - 6500	912	912	90	8.1	1	210
PL7UK44L15C	105	2835 SMD	PCB	10340	2700 - 6500	1192	1192	90	10.2	1	125
PL7UK55L15C	132	2835 SMD	PCB	12920	2700 - 6500	1473	1473	90	13.3	1	85
PL7UK66L15C	158	2835 SMD	PCB	15505	2700 - 6500	1752	1752	90	15.6	1	60
PL7UK88L15C	205	2835 SMD	PCB	20675	2700 - 6500	2314	2314	90	17.9	1	35
PL7UK23L15C	66	2835 SMD	PCB	6460	2700 - 6500	632	912	90	6.8	1	295
PL7UK24L15C	79	2835 SMD	PCB	7755	2700 - 6500	632	1192	90	7.9	1	230
PL7UK34L15C	92	2835 SMD	PCB	9050	2700 - 6500	912	1192	90	9.2	1	160
PL7UK35L15C	105	2835 SMD	PCB	10340	2700 - 6500	912	1473	90	10.2	1	130

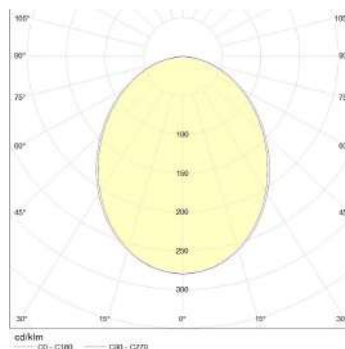
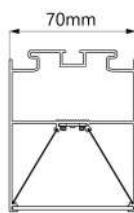
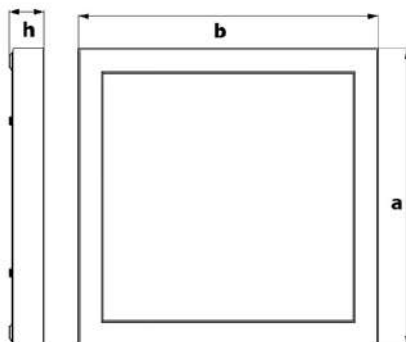

V / Hz 220 - 240 / 50 - 60

Options	Options
Dimmable electronic ballast or convertor. Emergency kit	Ballast électronique dimmable ou convertor. Kit d'urgence.
NOTE	NOTE
Given lumen values are net delivered luminaire output lumens.	Les valeurs de lumens données sont les lumens de sortie nets du luminaire.
Given power values are total consumed AC power of the luminaire.	Les valeurs de puissance données sont la puissance AC totale consommée du luminaire.

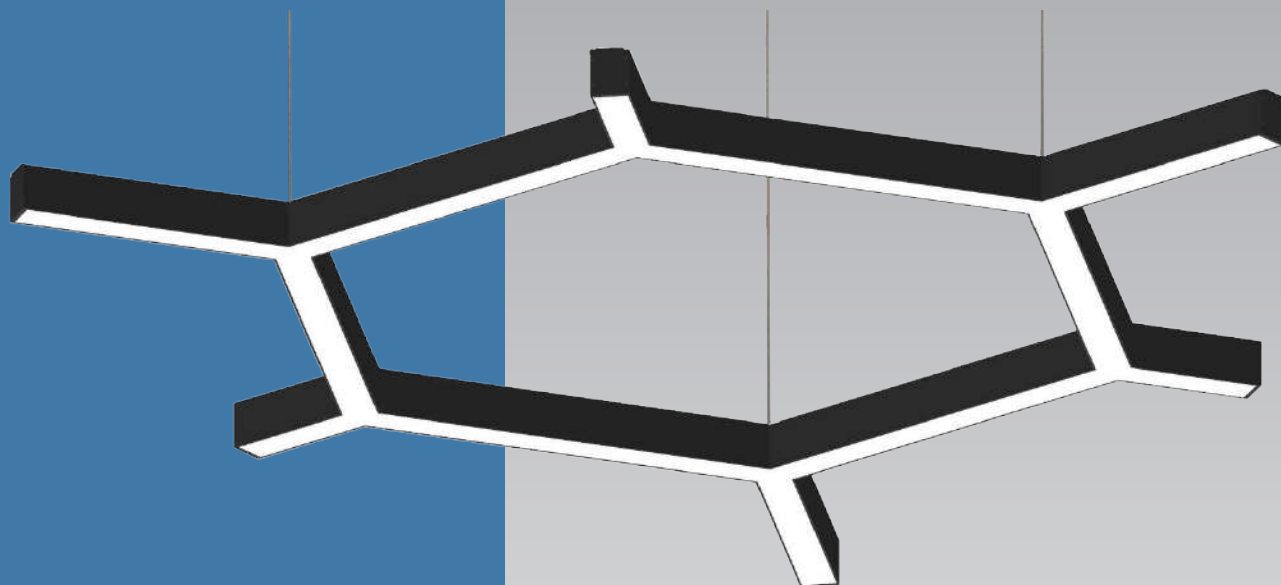

VEGA LOUNGE

LED

Suspended Lighting Fixtures With Frosted Diffuser

Luminaire Suspendus Avec Diffuseur Givré

APPLICATION AREAS

Shopping Malls
Supermarkets
Offices
Meeting rooms
Stores
Hospitals
Schools
Corridors

DOMAINES D'UTILISATION

Centres Commerciaux
Supermarchés
Bureaux
Salles de Réunions
Magasins
Hopitaux
Ecoles
Couloirs

BODY

Anodized aluminum with satin finishing. Black and white color options with elegant design.

DIFFUSER

UV stabilized frosted diffuser.

CONVERTER

Long life, low power loss converter with constant current. Compatible with ENEC standards.

LED

LED modules with 60.000 hours lifetime LUMILEDS / SAMSUNG / NICHIA brand LEDs.

SUSPENSION

Composed of 1mm steel wire rope and nickel-plated brass components. Suspension height is adjustable. Supplied with transparent electric cord and ceiling mounted electrical junction box with aesthetic design

CORPS

Corps en aluminium anodisé, satiné. Design élégant. Couleurs blanc, noir disponibles.

DIFFUSEUR

Diffuseur givré. Anti UV.

CONVERTEUR

Convertisseur, conforme aux normes ENEC. Longue vie. Perte de puissance faible avec courant constant.

LED

Modules LED – Durée de vie 60.000 heures avec LED de marque LUMILEDS / SAMSUNG / NICHIA.

SYSTEME DE FIXATION

Composé d'un fil en acier de 1mm, de composants en laiton nickelés. Livré avec un cordon électrique transparent et une boîte de jonction électrique à fixer au plafond. Hauteur de fixation réglable.

Color Options
Options de Couleur



LED Type / Type LED

Color Rendering Index / Indice de Rendu des Couleurs: (CRI): Ra>80

Code	Power Puissance (W)	LED Type Type De LED	LED Module Module LED	Lum. Flux Flux Lum. (lm)	Color Temperature Température De Couleur (K)	Dimensions (mm)				Weight Poids (kg)	Packing Quantity Colisage	Pcs./20" Container Pcs./20" Conteneur
						a	l	h	w			
PL7SYL33L15CS	39	2835 SMD	PCB	3880	2700 - 6500	70	525	90	1065	4.1	1	304
PL7SYL63L15CS	60	2835 SMD	PCB	5815	2700 - 6500	70	806	90	1550	6.1	1	143
PL7SYL66L15CS	79	2835 SMD	PCB	7755	2700 - 6500	70	1086	90	2036	8.1	1	83

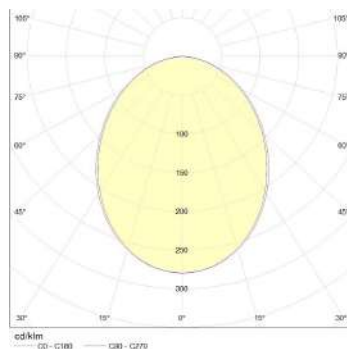
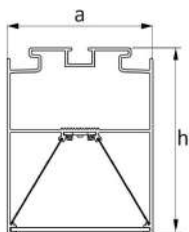
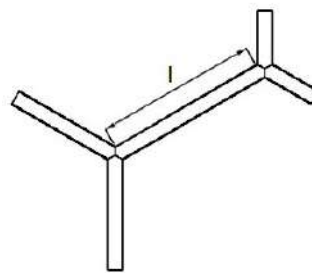
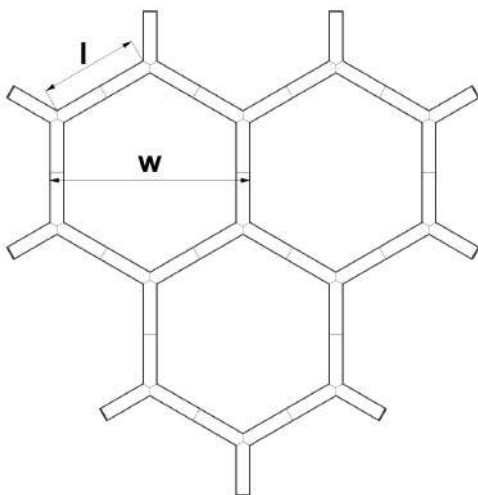

V / Hz 220 - 240 / 50 - 60

Options	Options
Dimmable electronic ballast or convertor. Emergency kit	Ballast électronique dimmable ou converteur. Kit d'urgence.
NOTE	NOTE
Given lumen values are net delivered luminaire output lumens.	Les valeurs de lumens données sont les lumens de sortie nets du luminaire.
Given power values are total consumed AC power of the luminaire.	Les valeurs de puissance données sont la puissance AC totale consommée du luminaire.

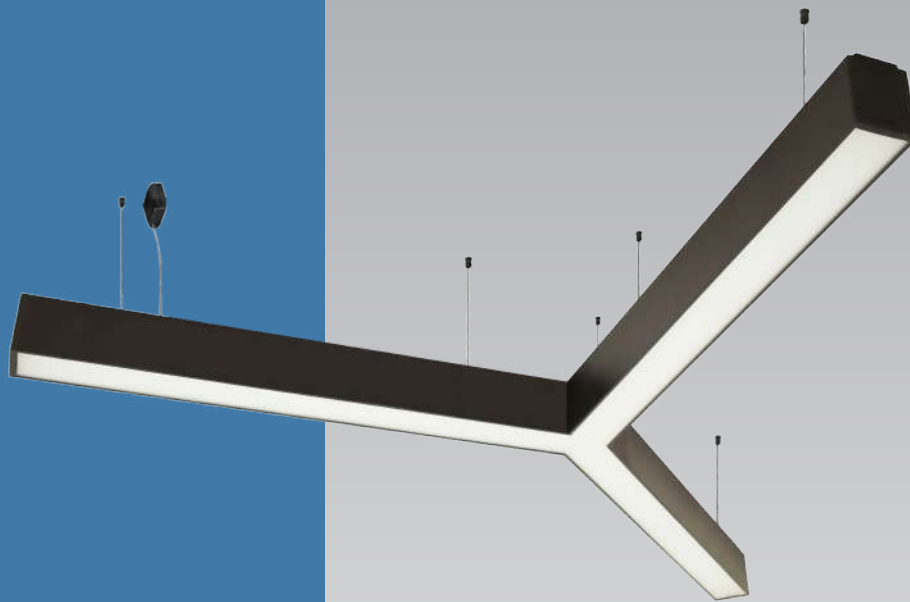

VEGA Y

LED

Suspended Lighting Fixtures With Frosted Diffuser

Luminaire Suspendus Avec Diffuseur Givré

APPLICATION AREAS

Shopping Malls
Supermarkets
Offices
Meeting rooms
Stores
Hospitals
Schools
Corridors

DOMAINES D'UTILISATION

Centres Commerciaux
Supermarchés
Bureaux
Salles de Réunions
Magasins
Hopitaux
Ecoles
Couloirs

BODY

Anodized aluminum with satin finishing. Black and white color options with elegant design.

DIFFUSER

UV stabilized frosted diffuser.

CONVERTER

Long life, low power loss converter with constant current. Compatible with ENEC standards.

LED

LED modules with 60.000 hours lifetime LUMILEDS / SAMSUNG / NICHIA brand LEDs.

SUSPENSION

Composed of 1mm steel wire rope and nickel-plated brass components. Suspension height is adjustable. Supplied with transparent electric cord and ceiling mounted electrical junction box with aesthetic design

CORPS

Corps en aluminium anodisé, satiné. Design élégant. Couleurs blanc, noir disponibles.

DIFFUSEUR

Diffuseur givré. Anti UV.

CONVERTEUR

Convertisseur, conforme aux normes ENEC. Longue vie. Perte de puissance faible avec courant constant.

LED

Modules LED – Durée de vie 60.000 heures avec LED de marque LUMILEDS / SAMSUNG / NICHIA.

SYSTEME DE FIXATION

Composé d'un fil en acier de 1mm, de composants en laiton nickelés. Livré avec un cordon électrique transparent et une boîte de jonction électrique à fixer au plafond. Hauteur de fixation réglable.

Color Options
Options de Couleur



LED Type / Type LED

Color Rendering Index / Indice de Rendu des Couleurs: (CRI): Ra>80

Code	Power Puissance (W)	LED Type Type De LED	LED Module Module LED	Lum. Flux Flux Lum. (lm)	Color Temperature Température De Couleur (K)	Dimensions (mm)			Weight Poids (kg)	Packing Quantity Colisage	Pcs./20" Container Pcs./20" Conteneur
						a	b	h			
PL7SY22L15C	39	2835 SMD	PCB	3880	2700 - 6500	870	994	90	4.3	1	205
PL7SY33L15C	60	2835 SMD	PCB	5815	2700 - 6500	1267	1472	90	6.1	1	95
PL7SY44L15C	79	2835 SMD	PCB	7755	2700 - 6500	1663	1951	90	8.2	1	55
PL7SY55L15C	99	2835 SMD	PCB	9690	2700 - 6500	2060	2430	90	10.5	1	35

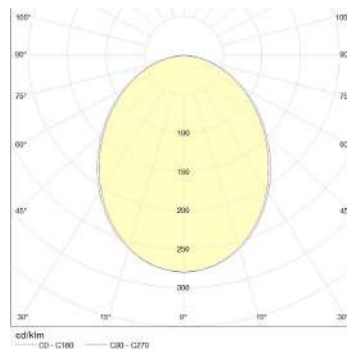
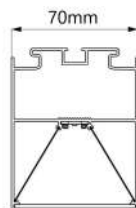
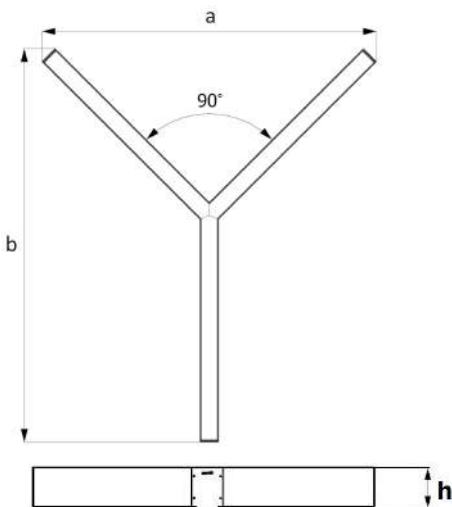

V / Hz 220 - 240 / 50 - 60

Options	Options
Dimmable electronic ballast or convertor. Emergency kit	Ballast électronique dimmable ou converteur. Kit d'urgence.
NOTE	NOTE
Given lumen values are net delivered luminaire output lumens.	Les valeurs de lumens données sont les lumens de sortie nets du luminaire.
Given power values are total consumed AC power of the luminaire.	Les valeurs de puissance données sont la puissance AC totale consommée du luminaire.

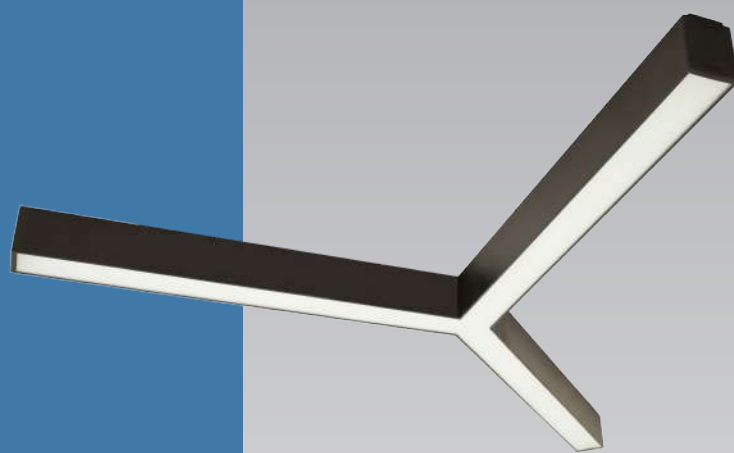

VEGA Y

LED

Surface Mounted Lighting Fixtures With Frosted Diffuser

Luminaire Apparents Avec Diffuseur Givré

APPLICATION AREAS

Shopping Malls
Supermarkets
Offices
Meeting rooms
Stores
Hospitals
Schools
Corridors

DOMAINES D'UTILISATION

Centres Commerciaux
Supermarchés
Bureaux
Salles de Réunions
Magasins
Hopitaux
Ecoles
Couloirs

BODY

Anodized aluminum with satin finishing. Black and white color options with elegant design.

DIFFUSER

UV stabilized frosted diffuser.

CONVERTER

Long life, low power loss converter with constant current. Compatible with ENEC standards.

LED

LED modules with 60.000 hours lifetime LUMILEDS / SAMSUNG / NICHIA brand LEDs.

CORPS

Corps en aluminium anodisé, satiné. Design élégant. Couleurs blanc, noir disponibles.

DIFFUSEUR

Diffuseur givré. Anti UV.

CONVERTEUR

Convertisseur, conforme aux normes ENEC. Longue vie. Perte de puissance faible avec courant constant.

LED

Modules LED – Durée de vie 60.000 heures avec LED de marque LUMILEDS / SAMSUNG / NICHIA.

Color Options
Options de Couleur



LED Type / Type LED

Color Rendering Index / Indice de Rendu des Couleurs: (CRI): Ra>80

Code	Power Puissance (W)	LED Type Type De LED	LED Module Module LED	Lum. Flux Flux Lum. (lm)	Color Temperature Température De Couleur (K)	Dimensions (mm)			Weight Poids (kg)	Packing Quantity Colisage	Pcs./20" Container Pcs./20" Conteneur
						a	b	h			
PL7UY22L15C	39	2835 SMD	PCB	3880	2700 - 6500	870	994	90	4.3	1	205
PL7UY33L15C	60	2835 SMD	PCB	5815	2700 - 6500	1267	1472	90	6.1	1	95
PL7UY44L15C	79	2835 SMD	PCB	7755	2700 - 6500	1663	1951	90	8.2	1	55
PL7UY55L15C	99	2835 SMD	PCB	9690	2700 - 6500	2060	2430	90	10.5	1	35

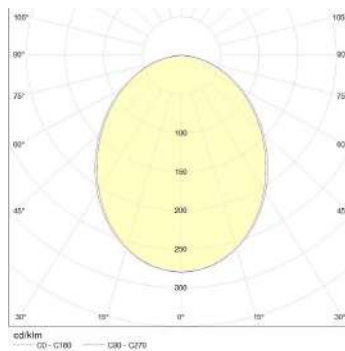
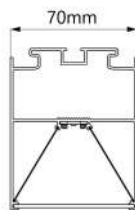
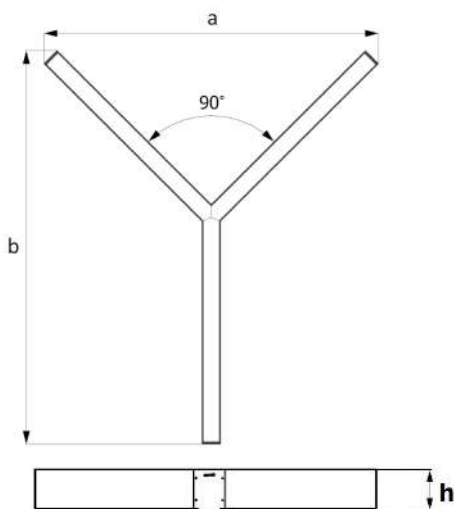

V / Hz 220 - 240 / 50 - 60

Options	Options
Dimmable electronic ballast or convertor. Emergency kit	Ballast électronique dimmable ou converteur. Kit d'urgence.
NOTE	NOTE
Given lumen values are net delivered luminaire output lumens.	Les valeurs de lumens données sont les lumens de sortie nets du luminaire.
Given power values are total consumed AC power of the luminaire.	Les valeurs de puissance données sont la puissance AC totale consommée du luminaire.

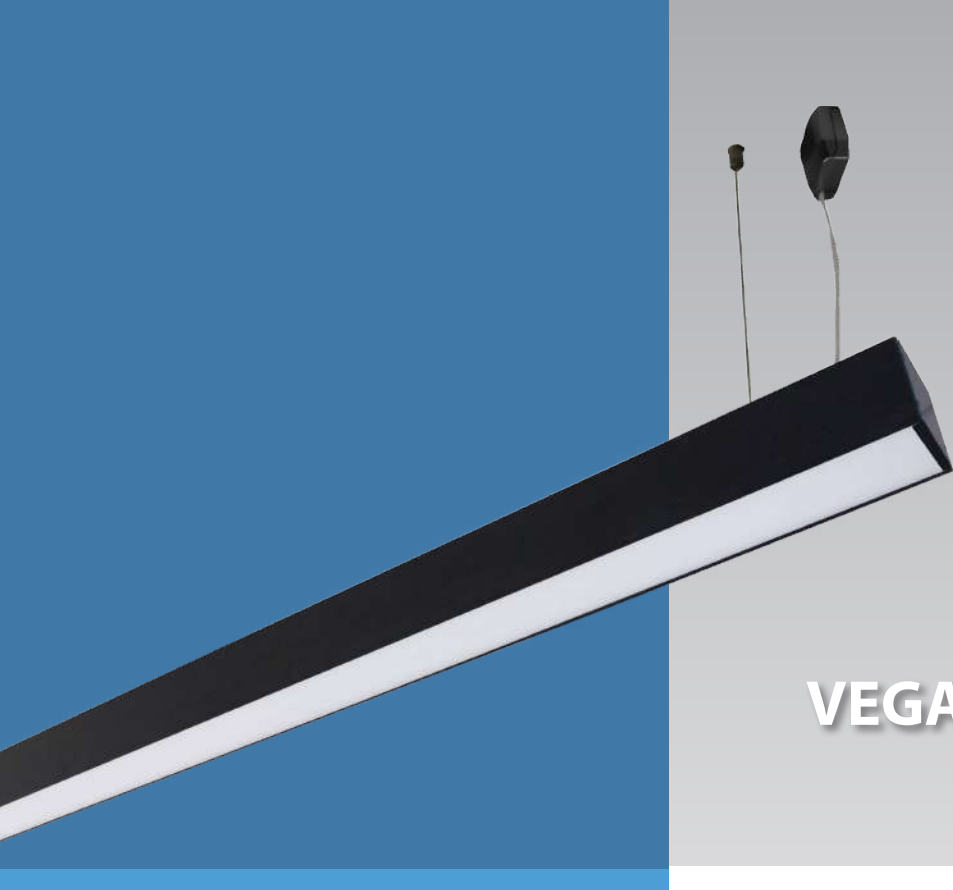

VEGA

LED

Suspended Lighting Fixtures With Frosted Diffuser

Luminaire suspendus Avec Diffuseur Givré

APPLICATION AREAS

Shopping Malls
Supermarkets
Offices
Meeting rooms
Stores
Hospitals
Schools
Corridors

DOMAINES D'UTILISATION

Centres Commerciaux
Supermarchés
Bureaux
Salles de Réunions
Magasins
Hopitaux
Ecoles
Couloirs

BODY

Anodized aluminum with satin finishing. Black and white color options with elegant design.

DIFFUSER

UV stabilized frosted diffuser.

CONVERTER

Long life, low power loss converter with constant current. Compatible with ENEC standards.

LED

LED modules with 60.000 hours lifetime LUMILEDS / SAMSUNG / NICHIA brand LEDs.

SUSPENSION

Composed of 1mm steel wire rope and nickel-plated brass components. Suspension height is adjustable. Supplied with transparent electric cord and ceiling mounted electrical junction box with aesthetic design

CORPS

Corps en aluminium anodisé, satiné. Design élégant. Couleurs blanc, noir disponibles.

DIFFUSEUR

Diffuseur givré. Anti UV.

CONVERTEUR

Convertisseur, conforme aux normes ENEC. Longue vie. Perte de puissance faible avec courant constant.

LED

Modules LED – Durée de vie 60.000 heures avec LED de marque LUMILEDS / SAMSUNG / NICHIA.

SYSTEME DE FIXATION

Composé d'un fil en acier de 1mm, de composants en laiton nickelés. Livré avec un cordon électrique transparent et une boîte de jonction électrique à fixer au plafond. Hauteur de fixation réglable.

Color Options
Options de Couleur



LED Type / Type LED

Color Rendering Index / Indice de Rendu des Couleurs: (CRI): Ra>80

Code	Power Puissance (W)	LED Type Type De LED	LED Module Module LED	Lum. Flux Flux Lum. (lm)	Color Temperature Température De Couleur (K)	Dimensions (mm)			Weight Poids (kg)	Packing Quantity Colisage	Pcs./20" Container Pcs./20" Conteneur
						a	l	h			
PL7S12L15C	14	2835 SMD	PCB	1295	2700 - 6500	70	570	90	1.9	4	2910
PL7S12L25C	21	2835 SMD	PCB	1945	2700 - 6500	70	570	90	2.0	4	2910
PL7S13L15C	21	2835 SMD	PCB	1940	2700 - 6500	70	850	90	2.5	4	2910
PL7S13L25C	30	2835 SMD	PCB	2920	2700 - 6500	70	850	90	2.6	4	2910
PL7S14L15C	26	2835 SMD	PCB	2585	2700 - 6500	70	1130	90	3.1	4	2270
PL7S14L25C	41	2835 SMD	PCB	3890	2700 - 6500	70	1130	90	3.2	4	2270
PL7S15L15C	33	2835 SMD	PCB	3230	2700 - 6500	70	1412	90	3.7	4	1840
PL7S15L25C	51	2835 SMD	PCB	4865	2700 - 6500	70	1412	90	3.8	4	1840
PL7S16L15C	39	2835 SMD	PCB	3880	2700 - 6500	70	1693	90	4.3	4	1575
PL7S16L25C	61	2835 SMD	PCB	5835	2700 - 6500	70	1693	90	4.4	4	1575
PL7S17L15C	47	2835 SMD	PCB	4525	2700 - 6500	70	1973	90	4.9	4	1250
PL7S17L25C	70	2835 SMD	PCB	6810	2700 - 6500	70	1973	90	5.1	4	1250
PL7S18L15C	53	2835 SMD	PCB	5170	2700 - 6500	70	2254	90	5.5	4	1250
PL7S19L15C	60	2835 SMD	PCB	5815	2700 - 6500	70	2534	90	6.1	4	1250
PL7S10L15C	66	2835 SMD	PCB	6460	2700 - 6500	70	2815	90	6.7	4	1000

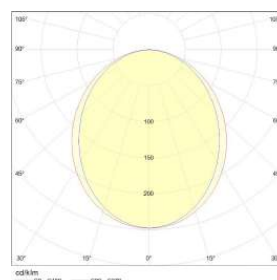
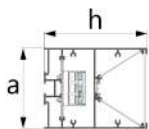

V / Hz 220 - 240 / 50 - 60

Options	Options
Dimmable electronic ballast or convertor. Emergency kit	Ballast électronique dimmable ou converteur. Kit d'urgence.

NOTE	NOTE
Given lumen values are net delivered luminaire output lumens.	Les valeurs de lumens données sont les lumens de sortie nets du luminaire.
Given power values are total consumed AC power of the luminaire.	Les valeurs de puissance données sont la puissance AC totale consommée du luminaire.

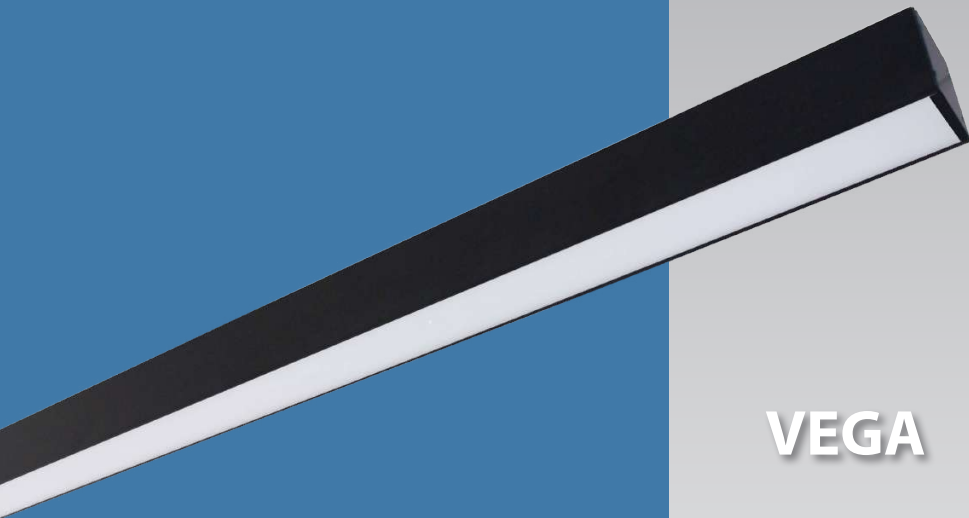

VEGA

LED

Surface Mounted Lighting Fixtures With Frosted Diffuser Luminaires Apparents Avec Diffuseur Givré

APPLICATION AREAS

Shopping Malls
Supermarkets
Offices
Meeting rooms
Stores
Hospitals
Schools
Corridors

DOMAINES D'UTILISATION

Centres Commerciaux
Supermarchés
Bureaux
Salles de Réunions
Magasins
Hopitaux
Ecoles
Couloirs

BODY

Anodized aluminum with satin finishing. Black and white color options with elegant design.

DIFFUSER

UV stabilized frosted diffuser.

CONVERTER

Long life, low power loss converter with constant current. Compatible with ENEC standards.

LED

LED modules with 60.000 hours lifetime LUMILEDS / SAMSUNG / NICHIA brand LEDs.

CORPS

Corps en aluminium anodisé, satiné. Design élégant. Couleurs blanc, noir disponibles.

DIFFUSEUR

Diffuseur givré. Anti UV.

CONVERTEUR

Convertisseur, conforme aux normes ENEC. Longue vie. Perte de puissance faible avec courant constant.

LED

Modules LED – Durée de vie 60.000 heures avec LED de marque LUMILEDS / SAMSUNG / NICHIA.

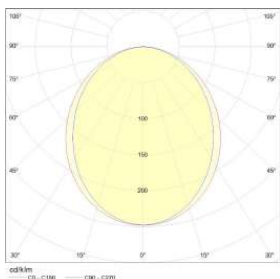

V / Hz 220 - 240 / 50 - 60

Options	Options
Dimmable electronic ballast or convertor.	Ballast électronique dimmable ou converteur.
Emergency kit	Kit d'urgence.

NOTE	NOTE
Given lumen values are net delivered luminaire output lumens.	Les valeurs de lumens données sont les lumens de sortie nets du luminaire.
Given power values are total consumed AC power of the luminaire.	Les valeurs de puissance données sont la puissance AC totale consommée du luminaire.

Color Options
Options de Couleur



LED Type / Type LED

Color Rendering Index / Indice de Rendu des Couleurs: (CRI): Ra>80

Code	Power Puissance (W)	LED Type Type De LED	LED Module Module LED	Lum. Flux Flux Lum. (lm)	Color Temperature Température De Couleur (K)	Dimensions (mm)			Weight Poids (kg)	Packing Quantity Colisage	Pcs./20" Container Pcs./20" Conteneur
						a	l	h			
PL7U12L15C	14	2835 SMD	PCB	1295	2700 - 6500	70	570	90	1,7	4	2930
PL7U12L25C	21	2835 SMD	PCB	1945	2700 - 6500	70	570	90	1,7	4	2930
PL7U13L15C	21	2835 SMD	PCB	1940	2700 - 6500	70	850	90	2,3	4	2010
PL7U13L25C	30	2835 SMD	PCB	2920	2700 - 6500	70	850	90	2,3	4	2010
PL7U14L15C	26	2835 SMD	PCB	2585	2700 - 6500	70	1130	90	2,9	4	2270
PL7U14L25C	41	2835 SMD	PCB	3890	2700 - 6500	70	1130	90	2,9	4	2270
PL7U15L15C	33	2835 SMD	PCB	3230	2700 - 6500	70	1412	90	3,5	4	1835
PL7U15L15CSB	33	2835 SMD	PCB	3230	2700 - 6500	70	1408	90	3,5	4	1835
PL7U15L15CS0	33	2835 SMD	PCB	3230	2700 - 6500	70	1404	90	3,5	4	1835
PL7U15L25C	51	2835 SMD	PCB	4865	2700 - 6500	70	1412	90	3,5	4	1835
PL7U15L25CSB	51	2835 SMD	PCB	4865	2700 - 6500	70	1408	90	3,5	4	1835
PL7U15L25CS0	51	2835 SMD	PCB	4865	2700 - 6500	70	1404	90	3,5	4	1835
PL7U16L15C	39	2835 SMD	PCB	3880	2700 - 6500	70	1693	90	4,1	4	1575
PL7U16L15CSB	39	2835 SMD	PCB	3880	2700 - 6500	70	1689	90	4,1	4	1575
PL7U16L15CS0	39	2835 SMD	PCB	3880	2700 - 6500	70	1685	90	4,1	4	1575
PL7U16L25C	61	2835 SMD	PCB	5835	2700 - 6500	70	1693	90	4,1	4	1575
PL7U16L25CSB	61	2835 SMD	PCB	5835	2700 - 6500	70	1689	90	4,1	4	1575
PL7U16L25CS0	61	2835 SMD	PCB	5835	2700 - 6500	70	1685	90	4,1	4	1575
PL7U17L15C	47	2835 SMD	PCB	4525	2700 - 6500	70	1973	90	4,7	4	1250
PL7U17L15CSB	47	2835 SMD	PCB	4525	2700 - 6500	70	1969	90	4,7	4	1250
PL7U17L15CS0	47	2835 SMD	PCB	4525	2700 - 6500	70	1965	90	4,7	4	1250
PL7U17L25C	70	2835 SMD	PCB	6810	2700 - 6500	70	1973	90	4,7	4	1250
PL7U17L25CSB	70	2835 SMD	PCB	6810	2700 - 6500	70	1969	90	4,7	4	1250
PL7U17L25CS0	70	2835 SMD	PCB	6810	2700 - 6500	70	1965	90	4,7	4	1250
PL7U18L15C	53	2835 SMD	PCB	5170	2700 - 6500	70	2254	90	5,3	4	1250
PL7U18L15CSB	53	2835 SMD	PCB	5170	2700 - 6500	70	2250	90	5,3	4	1250
PL7U18L15CS0	53	2835 SMD	PCB	5170	2700 - 6500	70	2246	90	5,3	4	1250
PL7U19L15C	60	2835 SMD	PCB	5815	2700 - 6500	70	2534	90	5,9	4	1250
PL7U19L15CSB	60	2835 SMD	PCB	5815	2700 - 6500	70	2530	90	5,9	4	1250
PL7U19L15CS0	60	2835 SMD	PCB	5815	2700 - 6500	70	2526	90	5,9	4	1250
PL7U10L15C	66	2835 SMD	PCB	6460	2700 - 6500	70	2815	90	6,5	4	1000
PL7U10L15CSB	66	2835 SMD	PCB	6460	2700 - 6500	70	2811	90	6,5	4	1000
PL7U10L15CS0	66	2835 SMD	PCB	6460	2700 - 6500	70	2807	90	6,5	4	1000

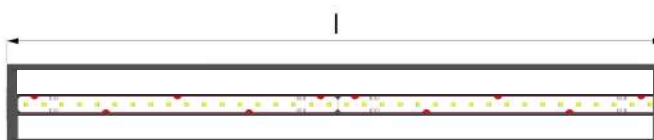
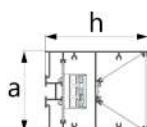





OPTIMUM

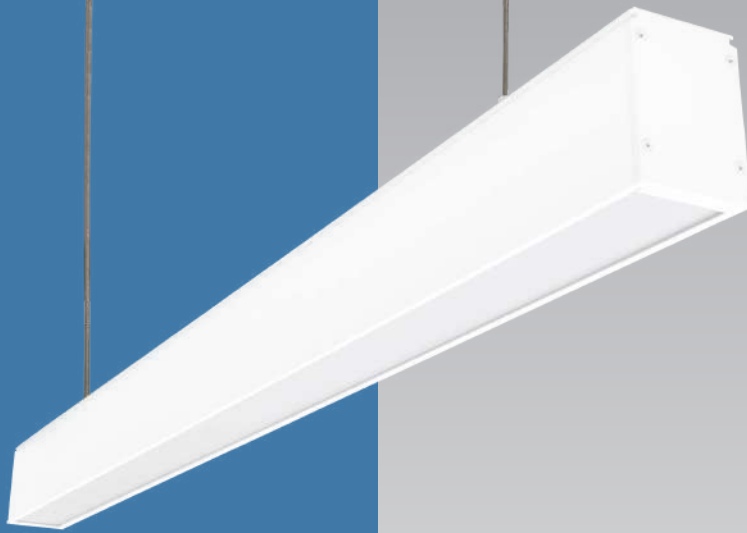

OPTIMUM

LED

Suspended Lighting Fixtures With Frosted Diffuser

Luminaire suspendus Avec Diffuseur Givré

APPLICATION AREAS

Shopping Malls
Supermarkets
Offices
Meeting rooms
Stores
Hospitals
Schools
Corridors

DOMAINES D'UTILISATION

Centres Commerciaux
Supermarchés
Bureaux
Salles de Réunions
Magasins
Hopitaux
Ecoles
Couloirs

BODY

Anodized aluminum with satin finishing. Black and white color options with elegant design.

DIFFUSER

UV stabilized frosted diffuser.

CONVERTER

Long life, low power loss converter with constant current. Compatible with ENEC standards.

LED

LED modules with 60.000 hours lifetime LUMILEDS / SAMSUNG / NICHIA brand LEDs.

SUSPENSION

Composed of 1mm steel wire rope and nickel-plated brass components. Suspension height is adjustable. Supplied with transparent electric cord and ceiling mounted electrical junction box with aesthetic design

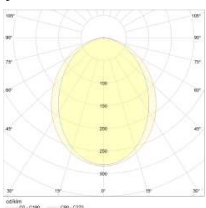

CORPS

Corps en aluminium anodisé, satiné. Design élégant. Couleurs blanc, noir disponibles.

DIFFUSEUR

Diffuseur givré. Anti UV.

CONVERTEUR

Convertisseur, conforme aux normes ENEC. Longue vie. Perte de puissance faible avec courant constant.

LED

Modules LED – Durée de vie 60.000 heures avec LED de marque LUMILEDS / SAMSUNG / NICHIA.

SYSTEME DE FIXATION

Composé d'un fil en acier de 1mm, de composants en laiton nickelés. Livré avec un cordon électrique transparent et une boîte de jonction électrique à fixer au plafond. Hauteur de fixation réglable.

V / Hz 220 - 240 / 50 - 60

Options

Dimmable electronic ballast or convertor.
Emergency kit

Options

Ballast électronique dimmable ou converteur.
Kit d'urgence.

NOTE

Given lumen values are net delivered luminaire output lumens.

Given power values are total consumed AC power of the luminaire.

NOTE

Les valeurs de lumens données sont les lumens de sortie nets du luminaire.

Les valeurs de puissance données sont la puissance AC totale consommée du luminaire.

Color Options
Options de Couleur



LED Type / Type LED

Color Rendering Index / Indice de Rendu des Couleurs: (CRI): Ra>80

Code	Power Puissance (W)	LED Type Type De LED	LED Module Module LED	Lum. Flux Flux Lum. (lm)	Color Temperature Température De Couleur (K)	Dimensions (mm)			Weight Poids (kg)	Packing Quantity Colisage	Pcs./20" Container Pcs./20" Conteneur
						a	l	h			
PL17S9C02C	15	2835 SMD	PCB	1445	2700 - 6500	57	675	85	1.9	5	3635
PL17S9C03C	20	2835 SMD	PCB	1910	2700 - 6500	57	675	85	1.9	5	3635
PL17S9C04C	26	2835 SMD	PCB	2320	2700 - 6500	57	675	85	1.9	5	3635
PL17S12C02C	19	2835 SMD	PCB	1920	2700 - 6500	57	895	85	2.3	5	3635
PL17S12C03C	27	2835 SMD	PCB	2540	2700 - 6500	57	895	85	2.3	5	3635
PL17S12C04C	35	2835 SMD	PCB	3090	2700 - 6500	57	895	85	2.3	5	3635
PL17S15C02C	24	2835 SMD	PCB	2395	2700 - 6500	57	1115	85	2.7	5	2835
PL17S15C03C	33	2835 SMD	PCB	3175	2700 - 6500	57	1115	85	2.7	5	2835
PL17S15C04C	43	2835 SMD	PCB	3860	2700 - 6500	57	1115	85	2.7	5	2835
PL17S18C02C	29	2835 SMD	PCB	2880	2700 - 6500	57	1334	85	3.1	5	2295
PL17S18C03C	40	2835 SMD	PCB	3805	2700 - 6500	57	1334	85	3.1	5	2295
PL17S18C04C	51	2835 SMD	PCB	4635	2700 - 6500	57	1334	85	3.1	5	2295
PL17S21C02C	33	2835 SMD	PCB	3355	2700 - 6500	57	1554	85	3.5	5	2295
PL17S21C03C	47	2835 SMD	PCB	4440	2700 - 6500	57	1554	85	3.5	5	2295
PL17S21C04C	60	2835 SMD	PCB	5405	2700 - 6500	57	1554	85	3.5	5	2295
PL17S24C02C	38	2835 SMD	PCB	3840	2700 - 6500	57	1774	85	3.9	5	1970
PL17S24C03C	53	2835 SMD	PCB	5075	2700 - 6500	57	1774	85	3.9	5	1970
PL17S24C04C	69	2835 SMD	PCB	6175	2700 - 6500	57	1774	85	3.9	5	1970
PL17S27C02C	43	2835 SMD	PCB	4315	2700 - 6500	57	1994	85	4.3	5	1560
PL17S27C03C	60	2835 SMD	PCB	5710	2700 - 6500	57	1994	85	4.3	5	1560
PL17S27C04C	77	2835 SMD	PCB	6945	2700 - 6500	57	1994	85	4.3	5	1560
PL17S30C02C	48	2835 SMD	PCB	4795	2700 - 6500	57	2214	85	4.7	5	1560
PL17S30C03C	67	2835 SMD	PCB	6345	2700 - 6500	57	2214	85	4.7	5	1560
PL17S30C04C	86	2835 SMD	PCB	7720	2700 - 6500	57	2214	85	4.7	5	1560

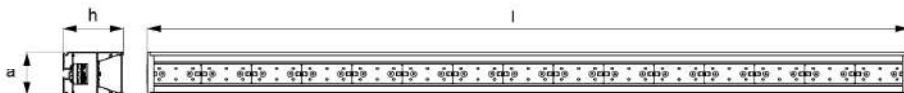



OPTIMUM

LED

Surface Mounted Lighting Fixtures With Frosted Diffuser Luminaires Apparents Avec Diffuseur Givré

APPLICATION AREAS

Shopping Malls
Supermarkets
Offices
Meeting rooms
Stores
Hospitals
Schools
Corridors

DOMAINES D'UTILISATION

Centres Commerciaux
Supermarchés
Bureaux
Salles de Réunions
Magasins
Hopitaux
Ecoles
Couloirs

BODY

Anodized aluminum with satin finishing. Black and white color options with elegant design.

DIFFUSER

UV stabilized frosted diffuser.

CONVERTER

Long life, low power loss converter with constant current. Compatible with ENEC standards.

LED

LED modules with 60.000 hours lifetime LUMILEDS / SAMSUNG / NICHIA brand LEDs.

CORPS

Corps en aluminium anodisé, satiné. Design élégant. Couleurs blanc, noir disponibles.

DIFFUSEUR

Diffuseur givré. Anti UV.

CONVERTEUR

Convertisseur, conforme aux normes ENEC. Longue vie. Perte de puissance faible avec courant constant.

LED

Modules LED – Durée de vie 60.000 heures avec LED de marque LUMILEDS / SAMSUNG / NICHIA.

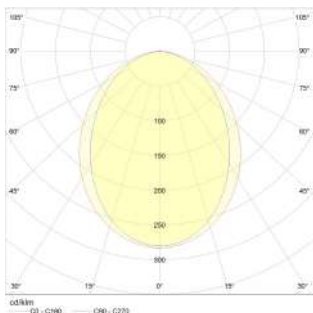

V / Hz 220 - 240 / 50 - 60

Options	Options
Dimmable electronic ballast or convertor.	Ballast électronique dimmable ou converteur.
Emergency kit	Kit d'urgence.

NOTE	NOTE
Given lumen values are net delivered luminaire output lumens.	Les valeurs de lumens données sont les lumens de sortie nets du luminaire.
Given power values are total consumed AC power of the luminaire.	Les valeurs de puissance données sont la puissance AC totale consommée du luminaire.

Color Options
Options de Couleur



LED Type / Type LED

Color Rendering Index / Indice de Rendu des Couleurs: (CRI): Ra>80

Code	Power Puissance (W)	LED Type Type De LED	LED Module Module LED	Lum. Flux Flux Lum. (lm)	Color Temperature Température De Couleur (K)	Dimensions (mm)			Weight Poids (kg)	Packing Quantity Colisage	Pcs./20" Container Pcs./20" Conteneur
						a	l	h			
PL17U9C02C	15	2835 SMD	PCB	1445	2700 - 6500	57	675	85	1.9	5	3635
PL17U9C03C	20	2835 SMD	PCB	1910	2700 - 6500	57	675	85	1.9	5	3635
PL17U9C04C	26	2835 SMD	PCB	2320	2700 - 6500	57	675	85	1.9	5	3635
PL17U12C02C	19	2835 SMD	PCB	1920	2700 - 6500	57	895	85	2.3	5	3635
PL17U12C03C	27	2835 SMD	PCB	2540	2700 - 6500	57	895	85	2.3	5	3635
PL17U12C04C	35	2835 SMD	PCB	3090	2700 - 6500	57	895	85	2.3	5	3635
PL17U15C02C	24	2835 SMD	PCB	2395	2700 - 6500	57	1115	85	2.7	5	2835
PL17U15C03C	33	2835 SMD	PCB	3175	2700 - 6500	57	1115	85	2.7	5	2835
PL17U15C04C	43	2835 SMD	PCB	3860	2700 - 6500	57	1115	85	2.7	5	2835
PL17U18C02C	29	2835 SMD	PCB	2880	2700 - 6500	57	1334	85	3.1	5	2295
PL17U18C03C	40	2835 SMD	PCB	3805	2700 - 6500	57	1334	85	3.1	5	2295
PL17U18C04C	51	2835 SMD	PCB	4635	2700 - 6500	57	1334	85	3.1	5	2295
PL17U21C02C	33	2835 SMD	PCB	3355	2700 - 6500	57	1554	85	3.5	5	2295
PL17U21C03C	47	2835 SMD	PCB	4440	2700 - 6500	57	1554	85	3.5	5	2295
PL17U21C04C	60	2835 SMD	PCB	5405	2700 - 6500	57	1554	85	3.5	5	2295
PL17U24C02C	38	2835 SMD	PCB	3840	2700 - 6500	57	1774	85	3.9	5	1970
PL17U24C03C	53	2835 SMD	PCB	5075	2700 - 6500	57	1774	85	3.9	5	1970
PL17U24C04C	69	2835 SMD	PCB	6175	2700 - 6500	57	1774	85	3.9	5	1970
PL17U27C02C	43	2835 SMD	PCB	4315	2700 - 6500	57	1994	85	4.3	5	1560
PL17U27C03C	60	2835 SMD	PCB	5710	2700 - 6500	57	1994	85	4.3	5	1560
PL17U27C04C	77	2835 SMD	PCB	6945	2700 - 6500	57	1994	85	4.3	5	1560
PL17U30C02C	48	2835 SMD	PCB	4795	2700 - 6500	57	2214	85	4.7	5	1560
PL17U30C03C	67	2835 SMD	PCB	6345	2700 - 6500	57	2214	85	4.7	5	1560
PL17U30C04C	86	2835 SMD	PCB	7720	2700 - 6500	57	2214	85	4.7	5	1560

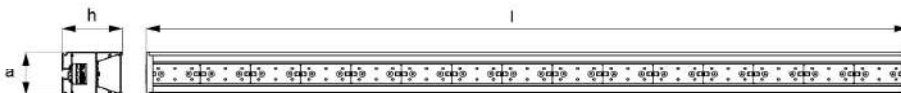



OPTIMUM RECESSED

LED

Recessed Lighting Fixtures With Diffuser

Luminaire Encastré Avec Diffuseur

APPLICATION AREAS

Shopping Malls
Supermarkets
Offices
Meeting rooms
Stores
Hospitals
Schools

DOMAINES D'UTILISATION

Centres Commerciaux
Supermarchés
Bureaux
Salles de Réunions
Magasins
Hopitaux
Ecoles

BODY

Anodized aluminum with satin finishing. Black and white color options with elegant design.

DIFFUSER

UV stabilized extruded PC diffuser.

CONVERTER

Long life, low power loss converter with constant current. Compatible with ENEC standards.

LED

LED modules with 60.000 hours lifetime LUMILEDS / SAMSUNG / NICHIA brand LEDs.

CORPS

Corps en aluminium anodisé, satiné. Design élégant. Couleurs blanc, noir disponibles.

DIFFUSEUR

Diffuseur en PC extrudé stabilisé aux UV.

CONVERTEUR

Convertisseur, conforme aux normes ENEC. Longue vie. Perte de puissance faible avec courant constant.

LED

Modules LED – Durée de vie 60.000 heures avec LED de marque LUMILEDS / SAMSUNG / NICHIA.

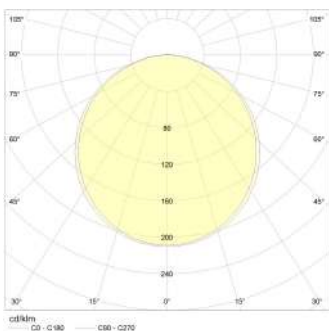

V / Hz 220 - 240 / 50 - 60

Options

Dimmable electronic ballast or convertor.
Emergency kit

Options

Ballast électronique dimmable ou converteur.
Kit d'urgence.

NOTE

Given lumen values are net delivered luminaire output lumens.

Given power values are total consumed AC power of the luminaire.

NOTE

Les valeurs de lumens données sont les lumens de sortie nets du luminaire.

Les valeurs de puissance données sont la puissance AC totale consommée du luminaire.

Color Options
Options de Couleur



LED Type / Type LED

Color Rendering Index / Indice de Rendu des Couleurs: (CRI): Ra>80

Code	Power Puissance (W)	LED Type Type De LED	LED Module Module LED	Lum. Flux Flux Lum. (lm)	Color Temperature Température De Couleur (K)	Dimensions (mm)			Weight Poids (kg)	Packing Quantity Colisage	Pcs./20" Container Pcs./20" Conteneur
						a	l	h			
PL18A9C02C	15	2835 SMD	PCB	1265	2700 - 6500	57	672	63	0.9	6	4360
PL18A9C03C	20	2835 SMD	PCB	1675	2700 - 6500	57	672	63	0.9	6	4360
PL18A9C04C	26	2835 SMD	PCB	2030	2700 - 6500	57	672	63	0.9	6	4360
PL18A12C02C	19	2835 SMD	PCB	1690	2700 - 6500	57	892	63	1.1	6	4360
PL18A12C03C	27	2835 SMD	PCB	2235	2700 - 6500	57	892	63	1.1	6	4360
PL18A12C04C	35	2835 SMD	PCB	2705	2700 - 6500	57	892	63	1.1	6	4360
PL18A15C02C	24	2835 SMD	PCB	2110	2700 - 6500	57	1112	63	1.3	6	3400
PL18A15C03C	33	2835 SMD	PCB	2790	2700 - 6500	57	1112	63	1.3	6	3400
PL18A15C04C	43	2835 SMD	PCB	3380	2700 - 6500	57	1112	63	1.3	6	3400
PL18A18C02C	29	2835 SMD	PCB	2535	2700 - 6500	57	1331	63	1.5	6	2750
PL18A18C03C	40	2835 SMD	PCB	3350	2700 - 6500	57	1331	63	1.5	6	2750
PL18A18C04C	51	2835 SMD	PCB	4055	2700 - 6500	57	1331	63	1.5	6	2750
PL18A21C02C	33	2835 SMD	PCB	2955	2700 - 6500	57	1551	63	1.7	6	2750
PL18A21C03C	47	2835 SMD	PCB	3910	2700 - 6500	57	1551	63	1.7	6	2750
PL18A21C04C	60	2835 SMD	PCB	4730	2700 - 6500	57	1551	63	1.7	6	2750
PL18A24C02C	38	2835 SMD	PCB	3375	2700 - 6500	57	1771	63	2.0	6	2360
PL18A24C03C	53	2835 SMD	PCB	4465	2700 - 6500	57	1771	63	2.0	6	2360
PL18A24C04C	69	2835 SMD	PCB	5405	2700 - 6500	57	1771	63	2.0	6	2360
PL18A27C02C	43	2835 SMD	PCB	3800	2700 - 6500	57	1991	63	2.2	6	1870
PL18A27C03C	60	2835 SMD	PCB	5025	2700 - 6500	57	1991	63	2.2	6	1870
PL18A27C04C	77	2835 SMD	PCB	6085	2700 - 6500	57	1991	63	2.2	6	1870
PL18A30C02C	48	2835 SMD	PCB	4220	2700 - 6500	57	2211	63	2.4	6	1870
PL18A30C03C	67	2835 SMD	PCB	5585	2700 - 6500	57	2211	63	2.4	6	1870
PL18A30C04C	86	2835 SMD	PCB	6760	2700 - 6500	57	2211	63	2.4	6	1870

Visible Frame Width / Largeur de Cadre Visible: 72mm







VEGA SLIM

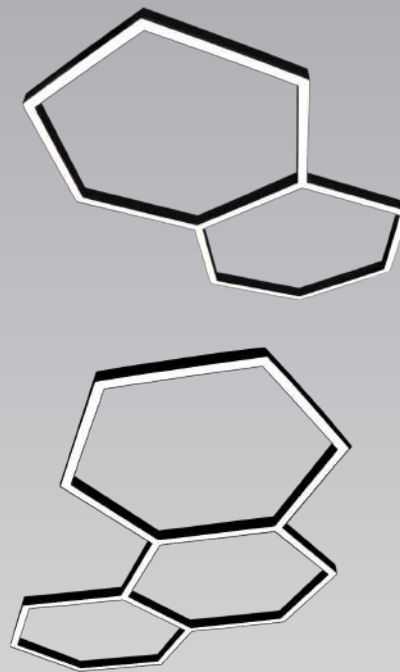
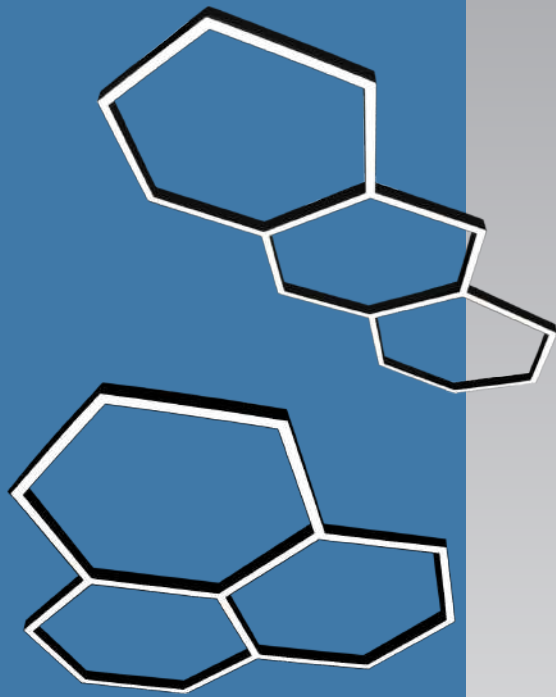

HEXAGONIA VEGA SLIM

LED

Suspended Lighting Fixtures With Diffuser

Luminaire Suspendus Avec Diffuseur

APPLICATION AREAS

Shopping Malls
Supermarkets
Offices
Meeting rooms
Stores
Hospitals
Schools
Corridors

DOMAINES D'UTILISATION

Centres Commerciaux
Supermarchés
Bureaux
Salles de Réunions
Magasins
Hopitaux
Ecoles
Couloirs

BODY

Anodized aluminum with satin finishing. Black and white color options with elegant design.

DIFFUSER

UV stabilized extruded PC diffuser.

CONVERTER

Long life, low power loss converter with constant current. Compatible with ENEC standards.

LED

LED modules with 60.000 hours lifetime LUMILEDS / SAMSUNG / NICHIA brand LEDs.

SUSPENSION

Composed of 1mm steel wire rope and nickel-plated brass components. Suspension height is adjustable. Supplied with transparent electric cord and ceiling mounted electrical junction box with aesthetic design

CORPS

Corps en aluminium anodisé, satiné. Design élégant. Couleurs blanc, noir disponibles.

DIFFUSEUR

Diffuseur en PC extrudé stabilisé aux UV.

CONVERTEUR

Convertisseur, conforme aux normes ENEC. Longue vie. Perte de puissance faible avec courant constant.

LED

Modules LED – Durée de vie 60.000 heures avec LED de marque LUMILEDS / SAMSUNG / NICHIA.

SYSTEME DE FIXATION

Composé d'un fil en acier de 1mm, de composants en laiton nickelés. Livré avec un cordon électrique transparent et une boîte de jonction électrique à fixer au plafond. Hauteur de fixation réglable.

Color Options
Options de Couleur



LED Type / Type LED

Color Rendering Index / Indice de Rendu des Couleurs: (CRI): Ra>80

Code	Power Puissance (W)	LED Type Type De LED	LED Module Module LED	Lum. Flux Flux Lum. (lm)	Color Temperature Température De Couleur (K)	Dimensions (mm)			Weight Poids (kg)	Packing Quantity Colisage	Pcs./20" Container Pcs./20" Conteneur
						a	b	h			
2PL13SA61L15C	73	2835 SMD	PCB/11	7420	2700 - 6500	1051	640	85	12	1	264
2PL13SA62L15C	145	2835 SMD	PCB/22	14840	2700 - 6500	2007	1192	85	22.5	1	77
3PL13SA61L15C1	99	2835 SMD	PCB/15	10120	2700 - 6500	1070	1051	85	16.5	1	160
3PL13SA61L15C2	106	2835 SMD	PCB/16	10795	2700 - 6500	1501	803	85	17.5	1	150
3PL13SA61L15C3	106	2835 SMD	PCB/16	10795	2700 - 6500	1548	640	85	17.5	1	176
3PL13SA62L15C1	198	2835 SMD	PCB/30	20235	2700 - 6500	2036	2007	85	30.5	1	45
3PL13SA62L15C2	211	2835 SMD	PCB/32	21585	2700 - 6500	2881	1520	85	32.5	1	43
3PL13SA62L15C3	211	2835 SMD	PCB/32	21585	2700 - 6500	2982	1192	85	32.5	1	43

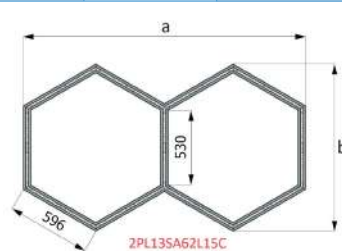
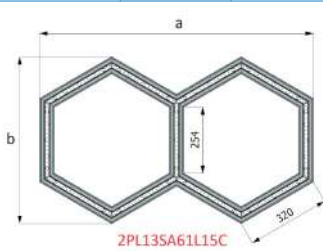

NOTE

Given lumen values are net delivered luminaire output lumens.

Given power values are total consumed AC power of the luminaire.

NOTE

Les valeurs de lumens données sont les lumens de sortie nets du luminaire.

Les valeurs de puissance données sont la puissance AC totale consommée du luminaire.

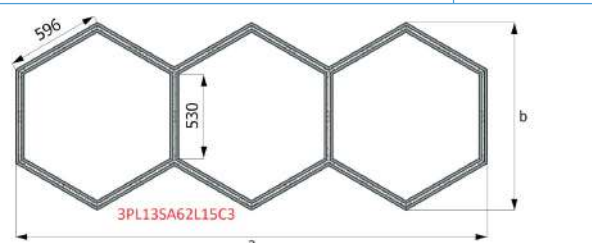
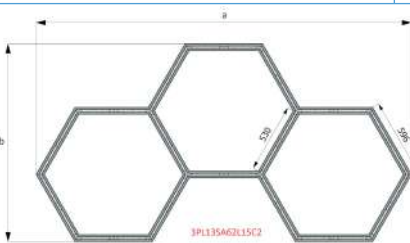
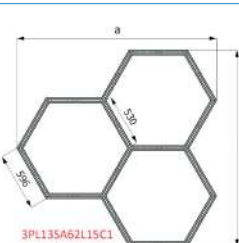
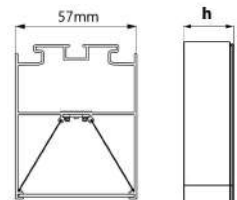
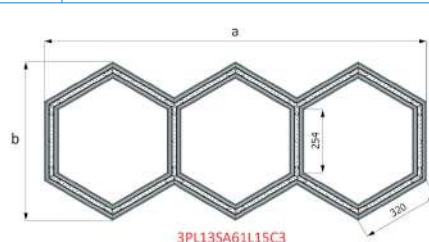
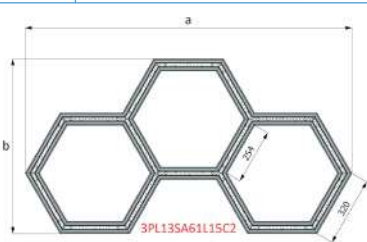
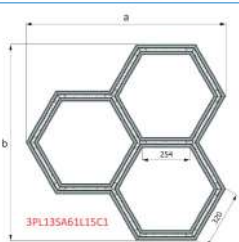
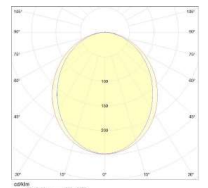

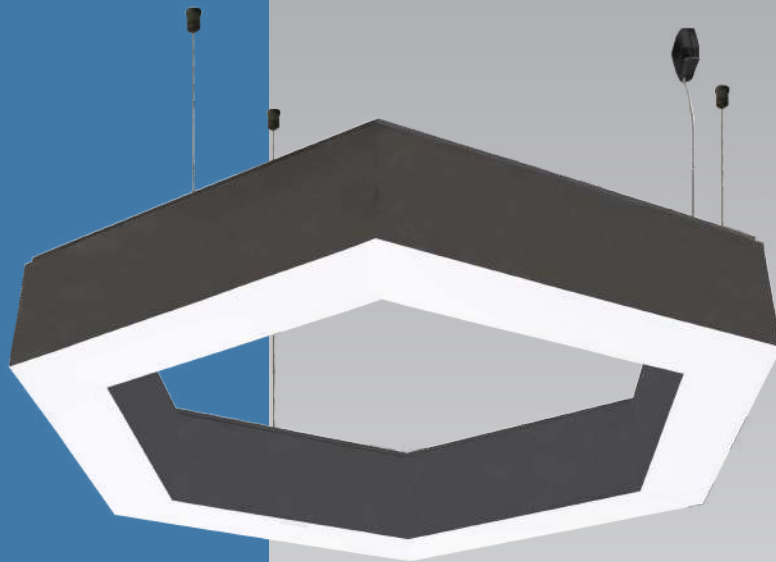

HEXAGON VEGA SLIM

LED

Suspended Lighting Fixtures With Diffuser

Luminaire suspendus Avec Diffuseur

APPLICATION AREAS

Shopping Malls
Supermarkets
Offices
Meeting rooms
Stores
Hospitals
Schools
Corridors

DOMAINES D'UTILISATION

Centres Commerciaux
Supermarchés
Bureaux
Salles de Réunions
Magasins
Hopitaux
Ecoles
Couloirs

BODY

Anodized aluminum with satin finishing. Black and white color options with elegant design.

DIFFUSER

UV stabilized extruded PC diffuser.

CONVERTER

Long life, low power loss converter with constant current. Compatible with ENEC standards.

LED

LED modules with 60.000 hours lifetime LUMILEDS / SAMSUNG / NICHIA brand LEDs.

SUSPENSION

Composed of 1mm steel wire rope and nickel-plated brass components. Suspension height is adjustable. Supplied with transparent electric cord and ceiling mounted electrical junction box with aesthetic design

CORPS

Corps en aluminium anodisé, satiné. Design élégant. Couleurs blanc, noir disponibles.

DIFFUSEUR

Diffuseur en PC extrudé stabilisé aux UV.

CONVERTEUR

Convertisseur, conforme aux normes ENEC. Longue vie. Perte de puissance faible avec courant constant.

LED

Modules LED – Durée de vie 60.000 heures avec LED de marque LUMILEDS / SAMSUNG / NICHIA.

SYSTEME DE FIXATION

Composé d'un fil en acier de 1mm, de composants en laiton nickelés. Livré avec un cordon électrique transparent et une boîte de jonction électrique à fixer au plafond. Hauteur de fixation réglable.

Color Options
Options de Couleur



LED Type / Type LED

Color Rendering Index / Indice de Rendu des Couleurs: (CRI): Ra>80

Code	Power Puissance (W)	LED Type Type De LED	LED Module Module LED	Lum. Flux Flux Lum. (lm)	Color Temperature Température De Couleur (K)	Dimensions (mm)			Weight Poids (kg)	Packing Quantity Colisage	Pcs./20" Container Pcs./20" Conteneur
						a	b	h			
PL13SA61L15C	39	2835 SMD	PCB	4050	2700 - 6500	632	547	85	6.5	4	470
PL13SA61L25C	61	2835 SMD	PCB	6070	2700 - 6500	632	547	85	9.1	4	470
PL13SA62L15C	79	2835 SMD	PCB	8095	2700 - 6500	1192	1032	85	12.2	4	140
PL13SA62L25C	120	2835 SMD	PCB	12145	2700 - 6500	1192	1032	85	15.3	4	140
PL13SA63L15C	118	2835 SMD	PCB	12145	2700 - 6500	1753	1518	85	12.2	4	70
PL13SA63L25C	180	2835 SMD	PCB	18220	2700 - 6500	1753	1518	85	15.3	4	70

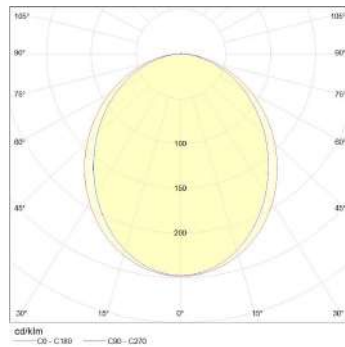
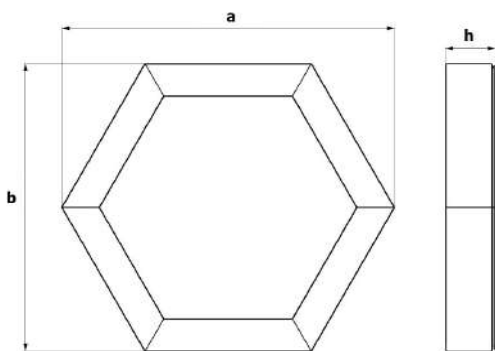
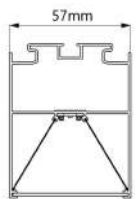

V / Hz 220 - 240 / 50 - 60

Options	Options
Dimmable electronic ballast or convertor. Emergency kit	Ballast électronique dimmable ou converteur. Kit d'urgence.
NOTE	NOTE
Given lumen values are net delivered luminaire output lumens.	Les valeurs de lumens données sont les lumens de sortie nets du luminaire.
Given power values are total consumed AC power of the luminaire.	Les valeurs de puissance données sont la puissance AC totale consommée du luminaire.

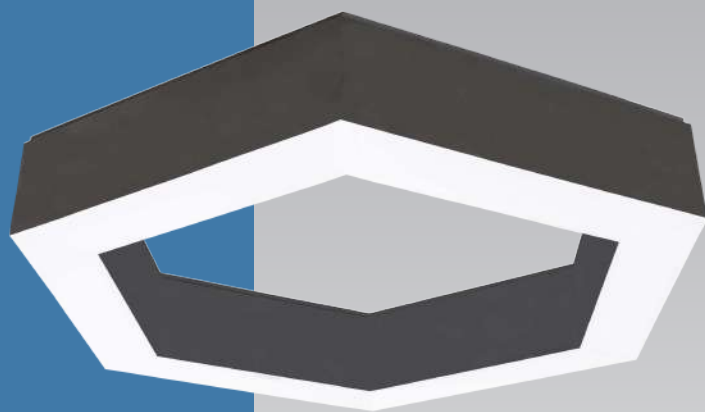

HEXAGON VEGA SLIM

LED

Surface Mounted Lighting Fixtures With Diffuser

Luminaire Apparents Avec Diffuseur

BODY

Anodized aluminum with satin finishing. Black and white color options with elegant design.

DIFFUSER

UV stabilized extruded PC diffuser.

CONVERTER

Long life, low power loss converter with constant current. Compatible with ENEC standards.

LED

LED modules with 60.000 hours lifetime LUMILEDS / SAMSUNG / NICHIA brand LEDs.

APPLICATION AREAS

Shopping Malls
Supermarkets
Offices
Meeting rooms
Stores
Hospitals
Schools
Corridors

DOMAINES D'UTILISATION

Centres Commerciaux
Supermarchés
Bureaux
Salles de Réunions
Magasins
Hopitaux
Ecoles
Couloirs

CORPS

Corps en aluminium anodisé, satiné. Design élégant. Couleurs blanc, noir disponibles.

DIFFUSEUR

Diffuseur en PC extrudé stabilisé aux UV.

CONVERTEUR

Convertisseur, conforme aux normes ENEC. Longue vie. Perte de puissance faible avec courant constant.

LED

Modules LED – Durée de vie 60.000 heures avec LED de marque LUMILEDS / SAMSUNG / NICHIA.

Color Options
Options de Couleur



LED Type / Type LED

Color Rendering Index / Indice de Rendu des Couleurs: (CRI): Ra>80

Code	Power Puissance (W)	LED Type Type De LED	LED Module Module LED	Lum. Flux Flux Lum. (lm)	Color Temperature Température De Couleur (K)	Dimensions (mm)			Weight Poids (kg)	Packing Quantity Colisage	Pcs./20" Container Pcs./20" Conteneur
						a	b	h			
PL13UA61L15C	39	2835 SMD	PCB	4050	2700 - 6500	632	547	85	6.5	4	470
PL13UA61L25C	61	2835 SMD	PCB	6070	2700 - 6500	632	547	85	9.1	4	470
PL13UA62L15C	79	2835 SMD	PCB	8095	2700 - 6500	1192	1032	85	12.2	4	140
PL13UA62L25C	120	2835 SMD	PCB	12145	2700 - 6500	1192	1032	85	15.3	4	140
PL13UA63L15C	118	2835 SMD	PCB	12145	2700 - 6500	1753	1518	85	12.2	4	70
PL13UA63L25C	180	2835 SMD	PCB	18220	2700 - 6500	1753	1518	85	15.3	4	70

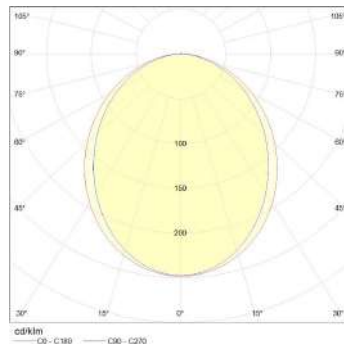
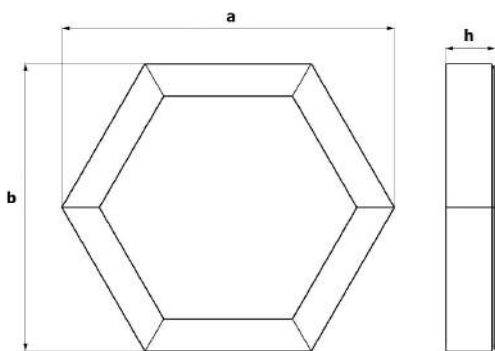
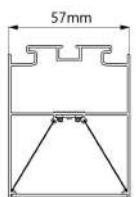

V / Hz 220 - 240 / 50 - 60

Options	Options
Dimmable electronic ballast or convertor. Emergency kit	Ballast électronique dimmable ou converteur. Kit d'urgence.
NOTE	NOTE
Given lumen values are net delivered luminaire output lumens.	Les valeurs de lumens données sont les lumens de sortie nets du luminaire.
Given power values are total consumed AC power of the luminaire.	Les valeurs de puissance données sont la puissance AC totale consommée du luminaire.



TRIANGLE VEGA SLIM

LED

Suspended Lighting Fixtures With Diffuser

Luminaire suspendu Avec Diffuseur

APPLICATION AREAS

Shopping Malls
Supermarkets
Offices
Meeting rooms
Stores
Hospitals
Schools
Corridors

DOMAINES D'UTILISATION

Centres Commerciaux
Supermarchés
Bureaux
Salles de Réunions
Magasins
Hopitaux
Ecoles
Couloirs

BODY

Anodized aluminum with satin finishing. Black and white color options with elegant design.

DIFFUSER

UV stabilized extruded PC diffuser.

CONVERTER

Long life, low power loss converter with constant current. Compatible with ENEC standards.

LED

LED modules with 60.000 hours lifetime LUMILEDS / SAMSUNG / NICHIA brand LEDs.

SUSPENSION

Composed of 1mm steel wire rope and nickel-plated brass components. Suspension height is adjustable. Supplied with transparent electric cord and ceiling mounted electrical junction box with aesthetic design

CORPS

Corps en aluminium anodisé, satiné. Design élégant. Couleurs blanc, noir disponibles.

DIFFUSEUR

Diffuseur en PC extrudé stabilisé aux UV.

CONVERTEUR

Convertisseur, conforme aux normes ENEC. Longue vie. Perte de puissance faible avec courant constant.

LED

Modules LED – Durée de vie 60.000 heures avec LED de marque LUMILEDS / SAMSUNG / NICHIA.

SYSTEME DE FIXATION

Composé d'un fil en acier de 1mm, de composants en laiton nickelés. Livré avec un cordon électrique transparent et une boîte de jonction électrique à fixer au plafond. Hauteur de fixation réglable.

Color Options
Options de Couleur



LED Type / Type LED

Color Rendering Index / Indice de Rendu des Couleurs: (CRI): Ra>80

Code	Power Puissance (W)	LED Type Type De LED	LED Module Module LED	Lum. Flux Flux Lum. (lm)	Color Temperature Température De Couleur (K)	Dimensions (mm)			Weight Poids (kg)	Packing Quantity Colisage	Pcs./20" Container Pcs./20" Conteneur
						a	b	h			
PL13STR23L15C	39	2835 SMD	PCB	4050	2700 - 6500	577	667	85	6.5	4	515
PL13STR33L15C	61	2835 SMD	PCB	6070	2700 - 6500	820	947	85	9.1	4	265
PL13STR43L15C	79	2835 SMD	PCB	8095	2700 - 6500	1063	1228	85	12.2	4	180
PL13STR53L15C	100	2835 SMD	PCB	10120	2700 - 6500	1306	1508	85	15.3	4	105
PL13STR63L15C	118	2835 SMD	PCB	12145	2700 - 6500	1549	1789	85	12.2	4	75
PL13STR73L15C	139	2835 SMD	PCB	14165	2700 - 6500	1792	2069	85	15.3	4	55

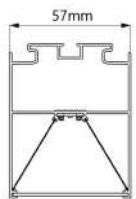
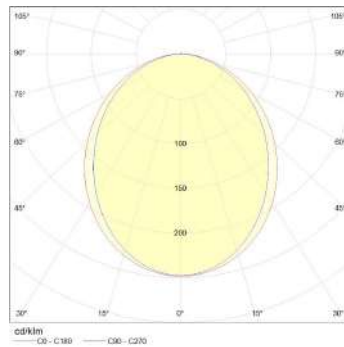
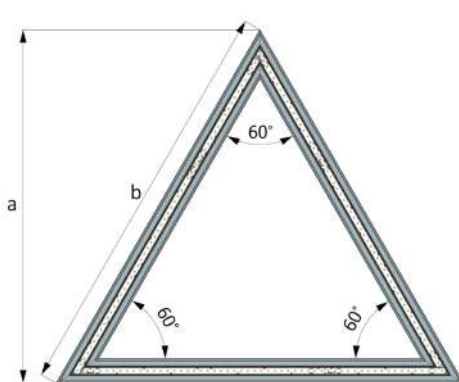

V / Hz 220 - 240 / 50 - 60

Options	Options
Dimmable electronic ballast or convertor. Emergency kit	Ballast électronique dimmable ou converteur. Kit d'urgence.
NOTE	NOTE
Given lumen values are net delivered luminaire output lumens.	Les valeurs de lumens données sont les lumens de sortie nets du luminaire.
Given power values are total consumed AC power of the luminaire.	Les valeurs de puissance données sont la puissance AC totale consommée du luminaire.



VEGA SLIM

LED

Suspended Lighting Fixtures With Diffuser

Luminaire suspendus Avec Diffuseur

APPLICATION AREAS

Shopping Malls
Supermarkets
Offices
Meeting rooms
Stores
Hospitals
Schools
Corridors

DOMAINES D'UTILISATION

Centres Commerciaux
Supermarchés
Bureaux
Salles de Réunions
Magasins
Hopitaux
Ecoles
Couloirs

BODY

Anodized aluminum with satin finishing. Black and white color options with elegant design.

DIFFUSER

UV stabilized extruded PC diffuser.

CONVERTER

Long life, low power loss converter with constant current. Compatible with ENEC standards.

LED

LED modules with 60.000 hours lifetime LUMILEDS / SAMSUNG / NICHIA brand LEDs.

SUSPENSION

Composed of 1mm steel wire rope and nickel-plated brass components. Suspension height is adjustable. Supplied with transparent electric cord and ceiling mounted electrical junction box with aesthetic design

CORPS

Corps en aluminium anodisé, satiné. Design élégant. Couleurs blanc, noir disponibles.

DIFFUSEUR

Diffuseur en PC extrudé stabilisé aux UV.

CONVERTEUR

Convertisseur, conforme aux normes ENEC. Longue vie. Perte de puissance faible avec courant constant.

LED

Modules LED – Durée de vie 60.000 heures avec LED de marque LUMILEDS / SAMSUNG / NICHIA.

SYSTEME DE FIXATION

Composé d'un fil en acier de 1mm, de composants en laiton nickelés. Livré avec un cordon électrique transparent et une boîte de jonction électrique à fixer au plafond. Hauteur de fixation réglable.

Color Options
Options de Couleur



LED Type / Type LED

Color Rendering Index / Indice de Rendu des Couleurs: (CRI): Ra>80

Code	Power Puissance (W)	LED Type Type De LED	LED Module Module LED	Lum. Flux Flux Lum. (lm)	Color Temperature Température De Couleur (K)	Dimensions (mm)			Weight Poids (kg)	Packing Quantity Colisage	Pcs./20" Container Pcs./20" Conteneur
						a	l	h			
PL13S12L15C	14	2835 SMD	PCB	1350	2700 - 6500	57	570	85	1.5	5	3635
PL13S12L25C	21	2835 SMD	PCB	2025	2700 - 6500	57	570	85	1.6	5	3635
PL13S13L15C	21	2835 SMD	PCB	2025	2700 - 6500	57	850	85	1.9	5	3635
PL13S13L25C	30	2835 SMD	PCB	3040	2700 - 6500	57	850	85	2.0	5	3635
PL13S14L15C	26	2835 SMD	PCB	2700	2700 - 6500	57	1130	85	2.3	5	2835
PL13S14L25C	41	2835 SMD	PCB	4050	2700 - 6500	57	1130	85	2.4	5	2835
PL13S15L15C	33	2835 SMD	PCB	3375	2700 - 6500	57	1412	85	2.7	5	2295
PL13S15L25C	51	2835 SMD	PCB	5065	2700 - 6500	57	1412	85	2.8	5	2295
PL13S16L15C	39	2835 SMD	PCB	4050	2700 - 6500	57	1693	85	3.1	5	1970
PL13S16L25C	61	2835 SMD	PCB	6075	2700 - 6500	57	1693	85	3.2	5	1970
PL13S17L15C	47	2835 SMD	PCB	4725	2700 - 6500	57	1973	85	3.5	5	1560
PL13S17L25C	70	2835 SMD	PCB	7090	2700 - 6500	57	1973	85	3.5	5	1560
PL13S18L15C	53	2835 SMD	PCB	5400	2700 - 6500	57	2254	85	3.9	5	1560
PL13S19L15C	60	2835 SMD	PCB	6070	2700 - 6500	57	2534	85	4.3	5	1255
PL13S10L15C	66	2835 SMD	PCB	6745	2700 - 6500	57	2815	85	4.7	5	1255

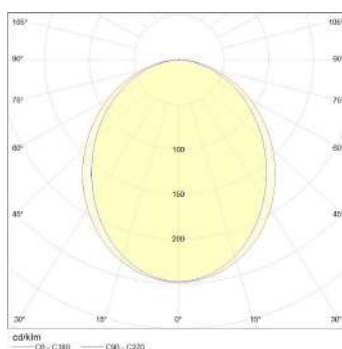
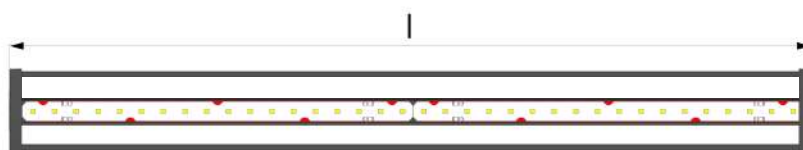
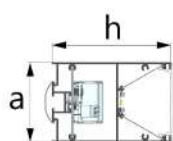

V / Hz 220 - 240 / 50 - 60

Options	Options
Dimmable electronic ballast or convertor. Emergency kit	Ballast électronique dimmable ou converteur. Kit d'urgence.

NOTE	NOTE
Given lumen values are net delivered luminaire output lumens.	Les valeurs de lumens données sont les lumens de sortie nets du luminaire.
Given power values are total consumed AC power of the luminaire.	Les valeurs de puissance données sont la puissance AC totale consommée du luminaire.



VEGA SLIM

LED

Surface Mounted Lighting Fixtures With Diffuser

Luminaire Apparents Avec Diffuseur

BODY

Anodized aluminum with satin finishing. Black and white color options with elegant design.

DIFFUSER

UV stabilized extruded PC diffuser.

CONVERTER

Long life, low power loss converter with constant current. Compatible with ENEC standards.

LED

LED modules with 60.000 hours lifetime LUMILEDS / SAMSUNG / NICHIA brand LEDs.

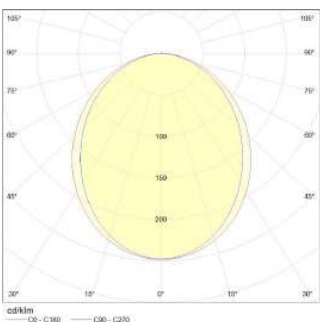

APPLICATION AREAS

Shopping Malls
Supermarkets
Offices
Meeting rooms
Stores
Hospitals
Schools
Corridors

DOMAINES D'UTILISATION

Centres Commerciaux
Supermarchés
Bureaux
Salles de Réunions
Magasins
Hopitaux
Ecoles
Couloirs

CORPS

Corps en aluminium anodisé, satiné. Design élégant. Couleurs blanc, noir disponibles.

DIFFUSEUR

Diffuseur en PC extrudé stabilisé aux UV.

CONVERTEUR

Convertisseur, conforme aux normes ENEC. Longue vie. Perte de puissance faible avec courant constant.

LED

Modules LED – Durée de vie 60.000 heures avec LED de marque LUMILEDS / SAMSUNG / NICHIA.

V / Hz		220 - 240 / 50 - 60	
Options	Options	NOTE	NOTE
Dimmable electronic ballast or convertor. Emergency kit	Ballast électronique dimmable ou converteur. Kit d'urgence.	Given lumen values are net delivered luminaire output lumens. Given power values are total consumed AC power of the luminaire.	Les valeurs de lumens données sont les lumens de sortie nets du luminaire. Les valeurs de puissance données sont la puissance AC totale consommée du luminaire.

Color Options
Options de Couleur



LED Type / Type LED

Color Rendering Index / Indice de Rendu des Couleurs: (CRI): Ra>80

Code	Power Puissance (W)	LED Type Type De LED	LED Module Module LED	Lum. Flux Flux Lum. (lm)	Color Temperature Température De Couleur (K)	Dimensions (mm)			Weight Poids (kg)	Packing Quantity Colisage	Pcs./20" Container Pcs./20" Conteneur
						a	l	h			
PL13U12L15C	14	2835 SMD	PCB	1350	2700 - 6500	57	570	85	1.3	5	3635
PL13U12L25C	21	2835 SMD	PCB	2025	2700 - 6500	57	570	85	1.4	5	3635
PL13U13L15C	21	2835 SMD	PCB	2025	2700 - 6500	57	850	85	1.7	5	3635
PL13U13L25C	30	2835 SMD	PCB	3040	2700 - 6500	57	850	85	1.8	5	3635
PL13U14L15C	26	2835 SMD	PCB	2700	2700 - 6500	57	1130	85	2.1	5	2835
PL13U14L25C	41	2835 SMD	PCB	4050	2700 - 6500	57	1130	85	2.2	5	2835
PL13U15L15C	33	2835 SMD	PCB	3375	2700 - 6500	57	1412	85	2.5	5	2295
PL13U15L15CSB	33	2835 SMD	PCB	3375	2700 - 6500	57	1408	85	2.5	5	2295
PL13U15L15CSO	33	2835 SMD	PCB	3375	2700 - 6500	57	1404	85	2.5	5	2295
PL13U15L25C	51	2835 SMD	PCB	5065	2700 - 6500	57	1412	85	2.6	5	2295
PL13U15L25CSB	51	2835 SMD	PCB	5065	2700 - 6500	57	1408	85	2.6	5	2295
PL13U15L25CSO	51	2835 SMD	PCB	5065	2700 - 6500	57	1404	85	2.6	5	2295
PL13U16L15C	39	2835 SMD	PCB	4050	2700 - 6500	57	1693	85	2.9	5	1970
PL13U16L15CSB	39	2835 SMD	PCB	4050	2700 - 6500	57	1689	85	2.9	5	1970
PL13U16L15CSO	39	2835 SMD	PCB	4050	2700 - 6500	57	1685	85	2.9	5	1970
PL13U16L25C	61	2835 SMD	PCB	6075	2700 - 6500	57	1693	85	3.0	5	1970
PL13U16L25CSB	61	2835 SMD	PCB	6075	2700 - 6500	57	1689	85	3.0	5	1970
PL13U16L25CSO	61	2835 SMD	PCB	6075	2700 - 6500	57	1685	85	3.0	5	1970
PL13U17L15C	47	2835 SMD	PCB	4725	2700 - 6500	57	1973	85	3.3	5	1560
PL13U17L15CSB	47	2835 SMD	PCB	4725	2700 - 6500	57	1969	85	3.3	5	1560
PL13U17L15CSO	47	2835 SMD	PCB	4725	2700 - 6500	57	1965	85	3.3	5	1560
PL13U17L25C	70	2835 SMD	PCB	7090	2700 - 6500	57	1973	85	3.3	5	1560
PL13U17L25CSB	70	2835 SMD	PCB	7090	2700 - 6500	57	1969	85	3.3	5	1560
PL13U17L25CSO	70	2835 SMD	PCB	7090	2700 - 6500	57	1965	85	3.3	5	1560
PL13U18L15C	53	2835 SMD	PCB	5400	2700 - 6500	57	2254	85	3.7	5	1560
PL13U18L15CSB	53	2835 SMD	PCB	5400	2700 - 6500	57	2250	85	3.7	5	1560
PL13U18L15CSO	53	2835 SMD	PCB	5400	2700 - 6500	57	2246	85	3.7	5	1560
PL13U19L15C	60	2835 SMD	PCB	6070	2700 - 6500	57	2534	85	4.1	5	1255
PL13U19L15CSB	60	2835 SMD	PCB	6070	2700 - 6500	57	2530	85	4.1	5	1255
PL13U19L15CSO	60	2835 SMD	PCB	6070	2700 - 6500	57	2526	85	4.1	5	1255
PL13U10L15C	66	2835 SMD	PCB	6745	2700 - 6500	57	2815	85	4.5	5	1255
PL13U10L15CSB	66	2835 SMD	PCB	6745	2700 - 6500	57	2811	85	4.5	5	1255
PL13U10L15CSO	66	2835 SMD	PCB	6745	2700 - 6500	57	2807	85	4.5	5	1255

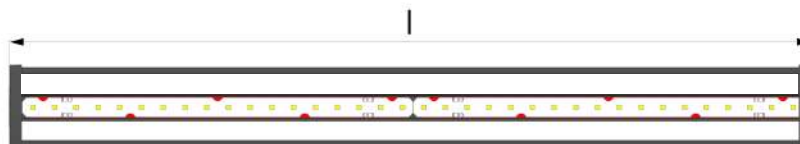
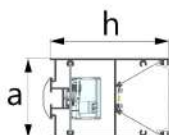





SIMETRI

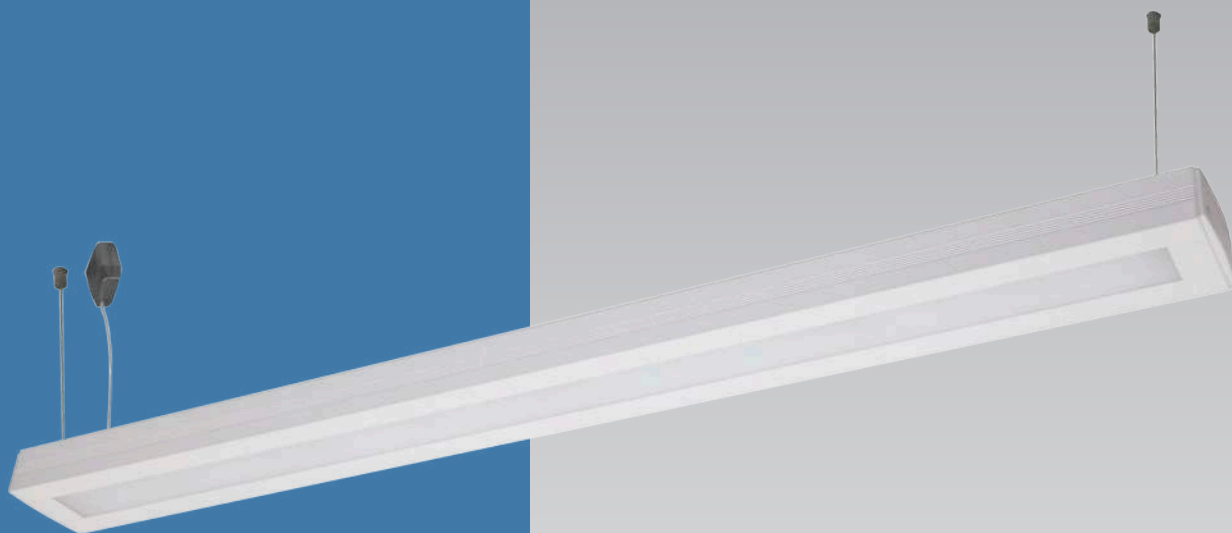

SIMETRI

LED

Suspended Lighting Fixtures With Frosted Diffuser

Luminaire Suspendu Avec Diffuseur Givré

APPLICATION AREAS

Shopping Malls
Supermarkets
Offices
Meeting rooms
Stores
Hospitals
Schools
Corridors

DOMAINES D'UTILISATION

Centres Commerciaux
Supermarchés
Bureaux
Salles de Réunions
Magasins
Hopitaux
Ecoles
Couloirs

BODY

Anodized aluminum with satin finishing. Black and white color options with elegant design.

DIFFUSER

UV stabilized frosted diffuser.

CONVERTER

Long life, low power loss converter with constant current. Compatible with ENEC standards.

LED

LED modules with 60.000 hours lifetime LUMILEDS / SAMSUNG / NICHIA brand LEDs.

SUSPENSION

Composed of 1mm steel wire rope and nickel-plated brass components. Suspension height is adjustable. Supplied with transparent electric cord and ceiling mounted electrical junction box with aesthetic design

CORPS

Corps en aluminium anodisé, satiné. Design élégant. Couleurs blanc, noir disponibles.

DIFFUSEUR

Diffuseur givré. Anti UV.

CONVERTEUR

Convertisseur, conforme aux normes ENEC. Longue vie. Perte de puissance faible avec courant constant.

LED

Modules LED – Durée de vie 60.000 heures avec LED de marque LUMILEDS / SAMSUNG / NICHIA.

SYSTEME DE FIXATION

Composé d'un fil en acier de 1mm, de composants en laiton nickelés. Livré avec un cordon électrique transparent et une boîte de jonction électrique à fixer au plafond. Hauteur de fixation réglable.

Indirect Lighting
Éclairage Indirect

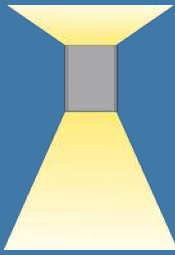

Direct Lighting
Éclairage Direct

Color Options
Options de Couleur



LED Type / Type LED

Color Rendering Index / Indice de Rendu des Couleurs: (CRI): Ra>80

Code	Power Puissance (W)	LED Type Type De LED	LED Module Module LED	Lum. Flux Flux Lum. (lm)	Color Temperature Température De Couleur (K)	Dimensions (mm)			Weight Poids (kg)	Packing Quantity Colisage	Pcs./20" Container Pcs./20" Conteneur
						a	l	h			
PL6S21L15C	21	2835 SMD	PCB	2140	2700 - 6500	104	628	48	1.3	5	1454
PL6S32L15C	33	2835 SMD	PCB	3565	2700 - 6500	104	908	48	1.7	5	1454
PL6S43L15C	47	2835 SMD	PCB	4990	2700 - 6500	104	1189	48	2.1	5	1134
PL6S54L15C	60	2835 SMD	PCB	6415	2700 - 6500	104	1469	48	2.5	5	920

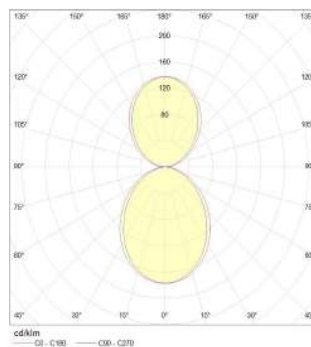
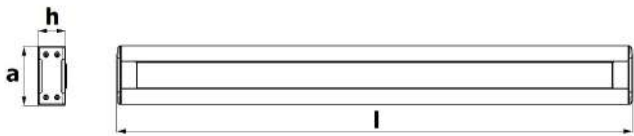

V / Hz | 220 - 240 / 50 - 60

Options	Options
Dimmable electronic ballast or convertor. Emergency kit	Ballast électronique dimmable ou converteur. Kit d'urgence.
NOTE	NOTE
Given lumen values are net delivered luminaire output lumens.	Les valeurs de lumens données sont les lumens de sortie nets du luminaire.
Given power values are total consumed AC power of the luminaire.	Les valeurs de puissance données sont la puissance AC totale consommée du luminaire.



APLIK / APPLIQUE

LED

Applique Lighting Fixtures With Frosted Diffuser

Luminaire Applique Avec Diffuseur Givré

APPLICATION AREAS

Shopping Malls
Supermarkets
Offices
Meeting rooms
Stores
Hospitals
Schools
Corridors

DOMAINES D'UTILISATION

Centres Commerciaux
Supermarchés
Bureaux
Salles de Réunions
Magasins
Hopitaux
Ecoles
Couloirs

BODY

Anodized aluminum with satin finishing. Black and white color options with elegant design.

DIFFUSER

UV stabilized frosted diffuser.

CONVERTER

Long life, low power loss converter with constant current. Compatible with ENEC standards.

LED

LED modules with 60.000 hours lifetime LUMILEDS / SAMSUNG / NICHIA brand LEDs.

CORPS

Corps en aluminium anodisé, satiné. Design élégant. Couleurs blanc, noir disponibles.

DIFFUSEUR

Diffuseur givré. Anti UV.

CONVERTEUR

Convertisseur, conforme aux normes ENEC. Longue vie. Perte de puissance faible avec courant constant.

LED

Modules LED – Durée de vie 60.000 heures avec LED de marque LUMILEDS / SAMSUNG / NICHIA.

Indirect Lighting
Éclairage Indirect

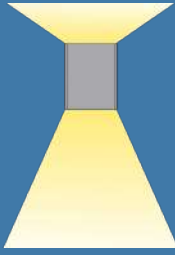

Direct Lighting
Éclairage Direct



Color Options
Options de Couleur



LED Type / Type LED

Color Rendering Index / Indice de Rendu des Couleurs: (CRI): Ra>80

Code	Power Puissance (W)	LED Type Type De LED	LED Module Module LED	Lum. Flux Flux Lum. (lm)	Color Temperature Température De Couleur (K)	Dimensions (mm)			Weight Poids (kg)	Packing Quantity Colisage	Pcs./20" Container Pcs./20" Conteneur
						a	b	h			
PL6U21L15C	14	2835 SMD	PCB	1425	2700 - 6500	104	347	48	0.9	5	1454
PL6U22L15C	26	2835 SMD	PCB	2850	2700 - 6500	104	628	48	1.5	5	1454
PL6U23L15C	39	2835 SMD	PCB	4275	2700 - 6500	104	908	48	2.2	5	1454
PL6U24L15C	53	2835 SMD	PCB	5700	2700 - 6500	104	1189	48	2.9	5	1134

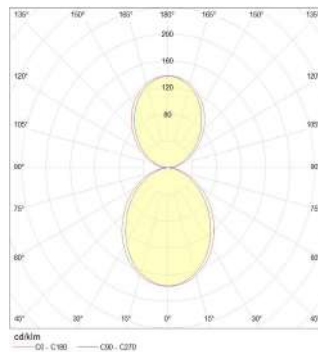
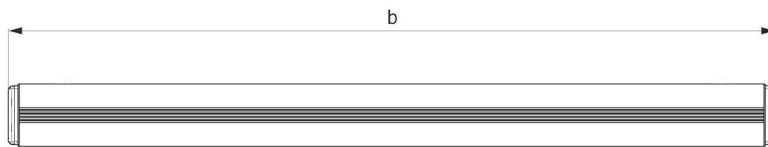
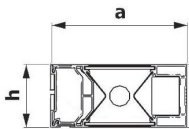

V / Hz | 220 - 240 / 50 - 60

Options	Options
Dimmable electronic ballast or convertor. Emergency kit	Ballast électronique dimmable ou converteur. Kit d'urgence.
NOTE	NOTE
Given lumen values are net delivered luminaire output lumens.	Les valeurs de lumens données sont les lumens de sortie nets du luminaire.
Given power values are total consumed AC power of the luminaire.	Les valeurs de puissance données sont la puissance AC totale consommée du luminaire.



 **pamir**[®]
aydınlatma



SIMETRI SLIM

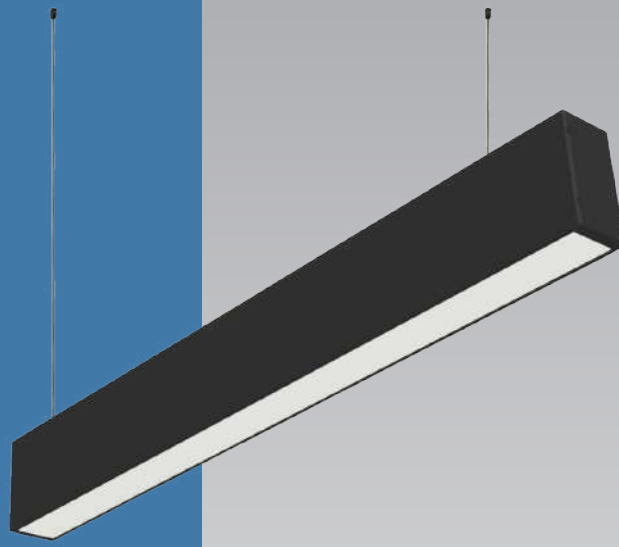

SIMETRI SLIM DIRECT / INDIRECT

LED

Suspended Lighting Fixtures With Frosted Diffuser

Luminaire Suspendus Avec Diffuseur Givré

APPLICATION AREAS

Shopping Malls
Supermarkets
Offices
Meeting rooms
Stores
Hospitals
Schools
Corridors

DOMAINES D'UTILISATION

Centres Commerciaux
Supermarchés
Bureaux
Salles de Réunions
Magasins
Hopitaux
Ecoles
Couloirs

BODY

Anodized aluminum with satin finishing. Black and white color options with elegant design.

DIFFUSER

UV stabilized frosted diffuser.

CONVERTER

Long life, low power loss converter with constant current. Compatible with ENEC standards.

LED

LED modules with 60.000 hours lifetime LUMILEDS / SAMSUNG / NICHIA brand LEDs.

SUSPENSION

Composed of 1mm steel wire rope and nickel-plated brass components. Suspension height is adjustable. Supplied with transparent electric cord and ceiling mounted electrical junction box with aesthetic design

CORPS

Corps en aluminium anodisé, satiné. Design élégant. Couleurs blanc, noir disponibles.

DIFFUSEUR

Diffuseur givré. Anti UV.

CONVERTEUR

Convertisseur, conforme aux normes ENEC. Longue vie. Perte de puissance faible avec courant constant.

LED

Modules LED – Durée de vie 60.000 heures avec LED de marque LUMILEDS / SAMSUNG / NICHIA.

SYSTEME DE FIXATION

Composé d'un fil en acier de 1mm, de composants en laiton nickelés. Livré avec un cordon électrique transparent et une boîte de jonction électrique à fixer au plafond. Hauteur de fixation réglable.

Indirect Lighting
Éclairage Indirect

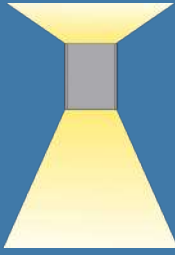

Direct Lighting
Éclairage Direct

Color Options
Options de Couleur



LED Type / Type LED

Color Rendering Index / Indice de Rendu des Couleurs: (CRI): Ra > 80

Code	Power Puissance (W)	LED Type Type De LED	LED Module Module LED	Lum. Flux Flux Lum. (lm)	Color Temperature Température De Couleur (K)	Dimensions (mm)			Weight Poids (kg)	Packing Quantity Colisage	Pcs./20" Container Pcs./20" Conteneur
						a	l	h			
PL21ES21L15C	14/8	2835 SMD	PCB	1090/665	2700 - 6500	40	570	76	1.4	6	4362
PL21ES21L25C	21/8	2835 SMD	PCB	1635/665	2700 - 6500	40	570	76	1.5	6	4362
PL21ES32L15C	21/14	2835 SMD	PCB	1625/1330	2700 - 6500	40	850	76	1.8	6	4362
PL21ES32L25C	30/14	2835 SMD	PCB	2440/1330	2700 - 6500	40	850	76	1.8	6	4362
PL21ES43L15C	26/21	2835 SMD	PCB	2170/1995	2700 - 6500	40	1130	76	2.3	6	3402
PL21ES43L25C	41/21	2835 SMD	PCB	3255/1995	2700 - 6500	40	1130	76	2.3	6	3402
PL21ES54L15C	33/26	2835 SMD	PCB	2710/2660	2700 - 6500	40	1410	76	2.8	6	2754
PL21ES54L25C	51/26	2835 SMD	PCB	4065/2660	2700 - 6500	40	1410	76	2.8	6	2754
PL21ES65L15C	39/33	2835 SMD	PCB	3250/3325	2700 - 6500	40	1693	76	3.3	6	2364
PL21ES65L25C	61/33	2835 SMD	PCB	4875/3325	2700 - 6500	40	1693	76	3.3	6	2364
PL21ES76L15C	47/39	2835 SMD	PCB	3790/3990	2700 - 6500	40	1973	76	3.8	6	1872
PL21ES76L25C	70/39	2835 SMD	PCB	5685/3990	2700 - 6500	40	1973	76	3.8	6	1872
PL21ES87L15C	53/47	2835 SMD	PCB	4335/4655	2700 - 6500	40	2254	76	4.3	6	1872
PL21ES98L15C	60/53	2835 SMD	PCB	4875/5320	2700 - 6500	40	2534	76	4.8	6	1506
PL21ES109L15C	66/60	2835 SMD	PCB	5415/5985	2700 - 6500	40	2815	76	5.3	6	1506

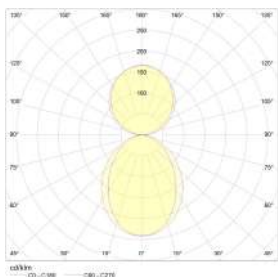
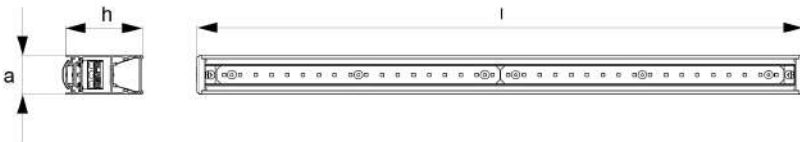

NOTE	NOTE
Given lumen values are net delivered luminaire output lumens.	Les valeurs de lumens données sont les lumens de sortie nets du luminaire.
Given power values are total consumed AC power of the luminaire.	Les valeurs de puissance données sont la puissance AC totale consommée du luminaire.

V / Hz 220 - 240 / 50 - 60

Options	Options
Dimmable electronic ballast or convertor.	Ballast électronique dimmable ou converteur.
Emergency kit	Kit d'urgence.
Magnet cap without screw.	Capuchon magnétique sans vis.



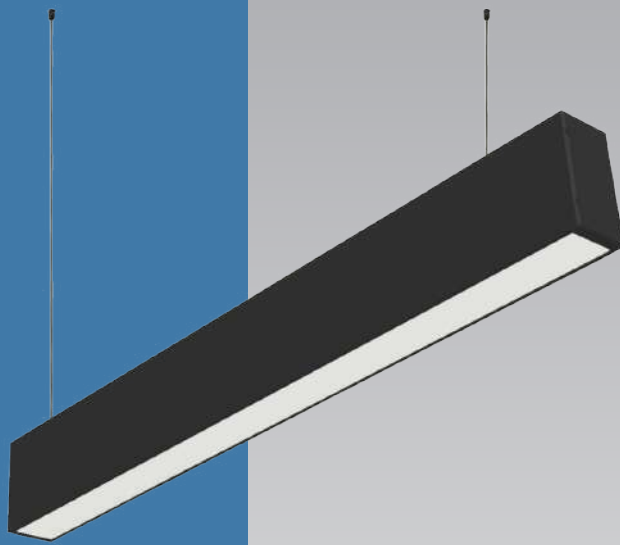

SIMETRI SLIM DIRECT

LED

Suspended Lighting Fixtures With Frosted Diffuser

Luminaire Suspendus Avec Diffuseur Givré

APPLICATION AREAS

Shopping Malls
Supermarkets
Offices
Meeting rooms
Stores
Hospitals
Schools
Corridors

DOMAINES D'UTILISATION

Centres Commerciaux
Supermarchés
Bureaux
Salles de Réunions
Magasins
Hopitaux
Ecoles
Couloirs

BODY

Anodized aluminum with satin finishing. Black and white color options with elegant design.

DIFFUSER

UV stabilized frosted diffuser.

CONVERTER

Long life, low power loss converter with constant current. Compatible with ENEC standards.

LED

LED modules with 60.000 hours lifetime LUMILEDS / SAMSUNG / NICHIA brand LEDs.

SUSPENSION

Composed of 1mm steel wire rope and nickel-plated brass components. Suspension height is adjustable. Supplied with transparent electric cord and ceiling mounted electrical junction box with aesthetic design

CORPS

Corps en aluminium anodisé, satiné. Design élégant. Couleurs blanc, noir disponibles.

DIFFUSEUR

Diffuseur givré. Anti UV.

CONVERTEUR

Convertisseur, conforme aux normes ENEC. Longue vie. Perte de puissance faible avec courant constant .

LED

Modules LED – Durée de vie 60.000 heures avec LED de marque LUMILEDS / SAMSUNG / NICHIA.

SYSTEME DE FIXATION

Composé d'un fil en acier de 1mm , de composants en laiton nickelés. Livré avec un cordon électrique transparent et une boîte de jonction électrique à fixer au plafond. Hauteur de fixation réglable.

Color Options
Options de Couleur



LED Type / Type LED

Color Rendering Index / Indice de Rendu des Couleurs: (CRI): Ra>80

Code	Power Puissance (W)	LED Type Type De LED	LED Module Module LED	Lum. Flux Flux Lum. (lm)	Color Temperature Température De Couleur (K)	Dimensions (mm)			Weight Poids (kg)	Packing Quantity Colisage	Pcs./20" Container Pcs./20" Conteneur
						a	l	h			
PL21S12L15C	14	2835 SMD	PCB	1090	2700 - 6500	40	570	76	1.4	6	4362
PL21S12L25C	21	2835 SMD	PCB	1635	2700 - 6500	40	570	76	1.5	6	4362
PL21S13L15C	21	2835 SMD	PCB	1625	2700 - 6500	40	850	76	1.8	6	4362
PL21S13L25C	30	2835 SMD	PCB	2440	2700 - 6500	40	850	76	1.8	6	4362
PL21S14L15C	26	2835 SMD	PCB	2170	2700 - 6500	40	1130	76	2.3	6	3402
PL21S14L25C	41	2835 SMD	PCB	3255	2700 - 6500	40	1130	76	2.3	6	3402
PL21S15L15C	33	2835 SMD	PCB	2710	2700 - 6500	40	1410	76	2.8	6	2754
PL21S15L25C	51	2835 SMD	PCB	4065	2700 - 6500	40	1410	76	2.8	6	2754
PL21S16L15C	39	2835 SMD	PCB	3250	2700 - 6500	40	1693	76	3.3	6	2364
PL21S16L25C	61	2835 SMD	PCB	4875	2700 - 6500	40	1693	76	3.3	6	2364
PL21S17L15C	47	2835 SMD	PCB	3790	2700 - 6500	40	1973	76	3.8	6	1872
PL21S17L25C	70	2835 SMD	PCB	5685	2700 - 6500	40	1973	76	3.8	6	1872
PL21S18L15C	53	2835 SMD	PCB	4335	2700 - 6500	40	2254	76	4.3	6	1872
PL21S19L15C	60	2835 SMD	PCB	4875	2700 - 6500	40	2534	76	4.8	6	1506
PL21S10L15C	66	2835 SMD	PCB	5415	2700 - 6500	40	2815	76	5.3	6	1506

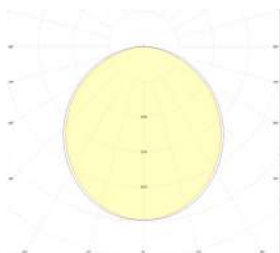
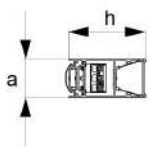

NOTE

Given lumen values are net delivered luminaire output lumens.

Given power values are total consumed AC power of the luminaire.

NOTE

Les valeurs de lumens données sont les lumens de sortie nets du luminaire.

Les valeurs de puissance données sont la puissance AC totale consommée du luminaire.

V / Hz 220 - 240 / 50 - 60

Options	Options
Dimmable electronic ballast or convertor.	Ballast electronic dimmable ou converteur.
Emergency kit	Kit d'urgence.
Magnet cap without screw.	Capuchon magnétique sans vis.



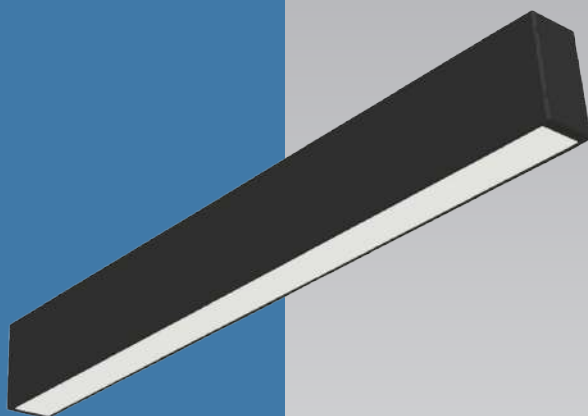

SIMETRI SLIM DIRECT

LED

Surface Mounted Lighting Fixtures With
Frosted Diffuser

Luminaire Apparents Avec Diffuseur Givré

APPLICATION AREAS

Shopping Malls
Supermarkets
Offices
Meeting rooms
Stores
Hospitals
Schools
Corridors

DOMAINES D'UTILISATION

Centres Commerciaux
Supermarchés
Bureaux
Salles de Réunions
Magasins
Hopitaux
Ecoles
Couloirs

BODY

Anodized aluminum with satin finishing. Black and white color options with elegant design.

DIFFUSER

UV stabilized frosted diffuser.

CONVERTER

Long life, low power loss converter with constant current. Compatible with ENEC standards.

LED

LED modules with 60.000 hours lifetime LUMILEDS / SAMSUNG / NICHIA brand LEDs.

CORPS

Corps en aluminium anodisé, satiné. Design élégant. Couleurs blanc, noir disponibles.

DIFFUSEUR

Diffuseur givré. Anti UV.

CONVERTEUR

Convertisseur, conforme aux normes ENEC. Longue vie. Perte de puissance faible avec courant constant.

LED

Modules LED – Durée de vie 60.000 heures avec LED de marque LUMILEDS / SAMSUNG / NICHIA.

Color Options
Options de Couleur



LED Type / Type LED

Color Rendering Index / Indice de Rendu des Couleurs: (CRI): Ra>80

Code	Power Puissance (W)	LED Type Type De LED	LED Module Module LED	Lum. Flux Flux Lum. (lm)	Color Temperature Température De Couleur (K)	Dimensions (mm)			Weight Poids (kg)	Packing Quantity Colisage	Pcs./20" Container Pcs./20" Conteneur
						a	l	h			
PL21U12L15C	14	2835 SMD	PCB	1090	2700 - 6500	40	570	76	1.4	6	4362
PL21U12L25C	21	2835 SMD	PCB	1635	2700 - 6500	40	570	76	1.5	6	4362
PL21U13L15C	21	2835 SMD	PCB	1625	2700 - 6500	40	850	76	1.8	6	4362
PL21U13L25C	30	2835 SMD	PCB	2440	2700 - 6500	40	850	76	1.8	6	4362
PL21U14L15C	26	2835 SMD	PCB	2170	2700 - 6500	40	1130	76	2.3	6	3402
PL21U14L25C	41	2835 SMD	PCB	3255	2700 - 6500	40	1130	76	2.3	6	3402
PL21U15L15C	33	2835 SMD	PCB	2710	2700 - 6500	40	1410	76	2.8	6	2754
PL21U15L25C	51	2835 SMD	PCB	4065	2700 - 6500	40	1410	76	2.8	6	2754
PL21U16L15C	39	2835 SMD	PCB	3250	2700 - 6500	40	1693	76	3.3	6	2364
PL21U16L25C	61	2835 SMD	PCB	4875	2700 - 6500	40	1693	76	3.3	6	2364
PL21U17L15C	47	2835 SMD	PCB	3790	2700 - 6500	40	1973	76	3.8	6	1872
PL21U17L25C	70	2835 SMD	PCB	5685	2700 - 6500	40	1973	76	3.8	6	1872
PL21U18L15C	53	2835 SMD	PCB	4335	2700 - 6500	40	2254	76	4.3	6	1872
PL21U19L15C	60	2835 SMD	PCB	4875	2700 - 6500	40	2534	76	4.8	6	1506
PL21U10L15C	66	2835 SMD	PCB	5415	2700 - 6500	40	2815	76	5.3	6	1506

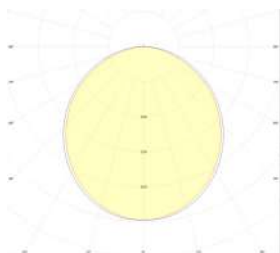
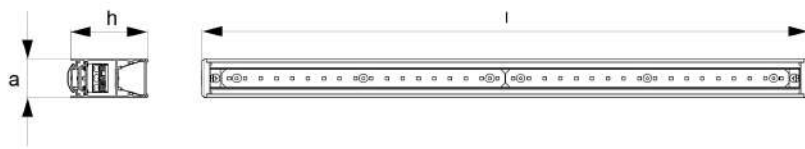

NOTE

Given lumen values are net delivered luminaire output lumens.

Given power values are total consumed AC power of the luminaire.

NOTE

Les valeurs de lumens données sont les lumens de sortie nets du luminaire.

Les valeurs de puissance données sont la puissance AC totale consommée du luminaire.

V / Hz 220 - 240 / 50 - 60

Options	Options
Dimmable electronic ballast or convertor.	Ballast electronic dimmable ou converteur.
Emergency kit	Kit d'urgence.
Magnet cap without screw.	Capuchon magnétique sans vis.





 pamir[®]
lighting



FLEKSI

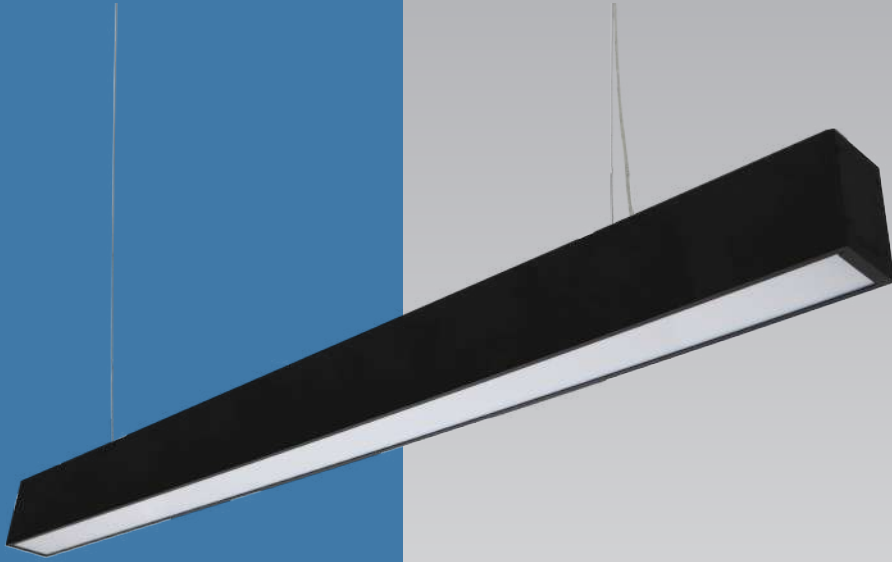

FLEKSI

LED

Suspended Lighting Fixtures With Frosted Diffuser

Luminaires Suspendus Avec Diffuseur Givré

APPLICATION AREAS

Shopping Malls
Supermarkets
Offices
Meeting rooms
Stores
Hospitals
Schools
Corridors

DOMAINES D'UTILISATION

Centres Commerciaux
Supermarchés
Bureaux
Salles de Réunions
Magasins
Hopitaux
Ecoles
Couloirs

BODY

Anodized aluminum with satin finishing. Black and white color options with elegant design.

DIFFUSER

UV stabilized frosted diffuser.

CONVERTER

Long life, low power loss converter with constant current. Compatible with ENEC standards.

LED

LED modules with 60.000 hours lifetime LUMILEDS / SAMSUNG / NICHIA brand LEDs.

SUSPENSION

Composed of 1mm steel wire rope and nickel-plated brass components. Suspension height is adjustable. Supplied with transparent electric cord and ceiling mounted electrical junction box with aesthetic design

CORPS

Corps en aluminium anodisé, satiné. Design élégant. Couleurs blanc, noir disponibles.

DIFFUSEUR

Diffuseur givré. Anti UV.

CONVERTEUR

Convertisseur, conforme aux normes ENEC. Longue vie. Perte de puissance faible avec courant constant .

LED

Modules LED – Durée de vie 60.000 heures avec LED de marque LUMILEDS / SAMSUNG / NICHIA.

SYSTEME DE FIXATION

Composé d'un fil en acier de 1mm , de composants en laiton nickelés. Livré avec un cordon électrique transparent et une boîte de jonction électrique à fixer au plafond. Hauteur de fixation réglable.

Color Options
Options de Couleur

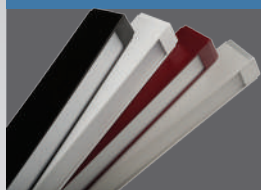

LED Type / Type LED

Color Rendering Index / Indice de Rendu des Couleurs: (CRI): Ra>80

Code	Power Puissance (W)	LED Type Type De LED	LED Module Module LED	Lum. Flux Flux Lum. (lm)	Color Temperature Température De Couleur (K)	Dimensions (mm)			Weight Poids (kg)	Packing Quantity Colisage	Pcs./20" Container Pcs./20" Conteneur
						a	b	h			
PL3S12L15C	14	2835 SMD	PCB	1405	2700 - 6500	57	570	85	1.9	2	1454
PL3S12L25C	21	2835 SMD	PCB	2105	2700 - 6500	57	570	85	1.9	2	1454
PL3S13L15C	21	2835 SMD	PCB	2105	2700 - 6500	57	850	85	2.2	2	1454
PL3S13L25C	30	2835 SMD	PCB	3160	2700 - 6500	57	850	85	2.2	2	1454
PL3S14L15C	26	2835 SMD	PCB	2810	2700 - 6500	57	1130	85	2.7	2	1134
PL3S14L25C	41	2835 SMD	PCB	4210	2700 - 6500	57	1130	85	2.7	2	1134
PL3S15L15C	33	2835 SMD	PCB	3510	2700 - 6500	57	1412	85	3.2	2	918
PL3S15L25C	51	2835 SMD	PCB	5265	2700 - 6500	57	1412	85	3.2	2	918
PL3S16L15C	39	2835 SMD	PCB	4210	2700 - 6500	57	1693	85	3.7	2	788
PL3S16L25C	61	2835 SMD	PCB	6320	2700 - 6500	57	1693	85	3.7	2	788
PL3S17L15C	47	2835 SMD	PCB	4915	2700 - 6500	57	1973	85	4.2	2	624
PL3S17L25C	70	2835 SMD	PCB	7370	2700 - 6500	57	1973	85	4.2	2	624
PL3S18L15C	53	2835 SMD	PCB	5615	2700 - 6500	57	2254	85	4.7	2	624
PL3S19L15C	60	2835 SMD	PCB	6320	2700 - 6500	57	2534	85	5.2	2	520
PL3S10L15C	66	2835 SMD	PCB	7020	2700 - 6500	57	2815	85	5.7	2	520

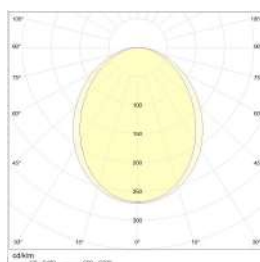
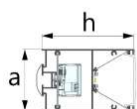

V / Hz 220 - 240 / 50 - 60

Options	Options
Dimmable electronic ballast or convertor. Emergency kit	Ballast électronique dimmable ou converteur. Kit d'urgence.
NOTE	NOTE
Given lumen values are net delivered luminaire output lumens.	Les valeurs de lumens données sont les lumens de sortie nets du luminaire.
Given power values are total consumed AC power of the luminaire.	Les valeurs de puissance données sont la puissance AC totale consommée du luminaire.

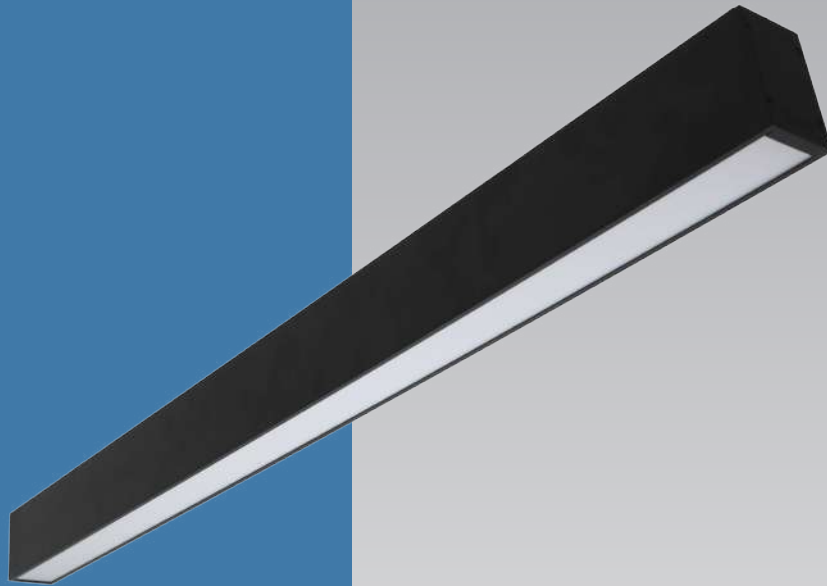

FLEKSI

LED

Surface Mounted Lighting Fixtures With Frosted Diffuser Luminaires Apparents Avec Diffuseur Givré

APPLICATION AREAS

Shopping Malls
Supermarkets
Offices
Meeting rooms
Stores
Hospitals
Schools
Corridors

DOMAINES D'UTILISATION

Centres Commerciaux
Supermarchés
Bureaux
Salles de Réunions
Magasins
Hopitaux
Ecoles
Couloirs

BODY

Anodized aluminum with satin finishing. Black and white color options with elegant design.

DIFFUSER

UV stabilized frosted diffuser.

CONVERTER

Long life, low power loss converter with constant current. Compatible with ENEC standards.

LED

LED modules with 60.000 hours lifetime LUMILEDS / SAMSUNG / NICHIA brand LEDs.

CORPS

Corps en aluminium anodisé, satiné. Design élégant. Couleurs blanc, noir disponibles.

DIFFUSEUR

Diffuseur givré. Anti UV.

CONVERTEUR

Convertisseur, conforme aux normes ENEC. Longue vie. Perte de puissance faible avec courant constant.

LED

Modules LED – Durée de vie 60.000 heures avec LED de marque LUMILEDS / SAMSUNG / NICHIA.

V / Hz		220 - 240 / 50 - 60	
Options		Options	
Dimmable electronic ballast or convertor.		Ballast électronique dimmable ou converteur.	
Emergency kit		Kit d'urgence.	

NOTE	NOTE
Given lumen values are net delivered luminaire output lumens.	Les valeurs de lumens données sont les lumens de sortie nets du luminaire.
Given power values are total consumed AC power of the luminaire.	Les valeurs de puissance données sont la puissance AC totale consommée du luminaire.

Color Options
Options de Couleur

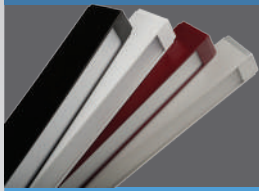

LED Type / Type LED

Color Rendering Index / Indice de Rendu des Couleurs: (CRI): Ra>80

Code	Power Puissance (W)	LED Type Type De LED	LED Module Module LED	Lum. Flux Flux Lum. (lm)	Color Temperature Température De Couleur (K)	Dimensions (mm)			Weight Poids (kg)	Packing Quantity Colisage	Pcs./20" Container Pcs./20" Conteneur
						a	b	h			
PL3U12L15C	14	2835 SMD	PCB	1405	2700 - 6500	57	570	85	1,9	2	2930
PL3U12L25C	21	2835 SMD	PCB	2105	2700 - 6500	57	570	85	1,9	2	2930
PL3U13L15C	21	2835 SMD	PCB	2105	2700 - 6500	57	850	85	2,3	2	2010
PL3U13L25C	30	2835 SMD	PCB	3160	2700 - 6500	57	850	85	2,3	2	2010
PL3U14L15C	26	2835 SMD	PCB	2810	2700 - 6500	57	1130	85	2,9	2	2270
PL3U14L25C	41	2835 SMD	PCB	4210	2700 - 6500	57	1130	85	2,9	2	2270
PL3U15L15C	33	2835 SMD	PCB	3510	2700 - 6500	57	1412	85	3,5	2	1835
PL3U15L15CSB	33	2835 SMD	PCB	3510	2700 - 6500	57	1408	85	3,5	2	1835
PL3U15L15CSO	33	2835 SMD	PCB	3510	2700 - 6500	57	1404	85	3,5	2	1835
PL3U15L25C	51	2835 SMD	PCB	5265	2700 - 6500	57	1412	85	3,5	2	1835
PL3U15L25CSB	51	2835 SMD	PCB	5265	2700 - 6500	57	1408	85	3,5	2	1835
PL3U15L25CSO	51	2835 SMD	PCB	5265	2700 - 6500	57	1404	85	3,5	2	1835
PL3U16L15C	39	2835 SMD	PCB	4210	2700 - 6500	57	1693	85	4,1	2	1575
PL3U16L15CSB	39	2835 SMD	PCB	4210	2700 - 6500	57	1689	85	4,1	2	1575
PL3U16L15CSO	39	2835 SMD	PCB	4210	2700 - 6500	57	1685	85	4,1	2	1575
PL3U16L25C	61	2835 SMD	PCB	6320	2700 - 6500	57	1693	85	4,1	2	1575
PL3U16L25CSB	61	2835 SMD	PCB	6320	2700 - 6500	57	1689	85	4,1	2	1575
PL3U16L25CSO	61	2835 SMD	PCB	6320	2700 - 6500	57	1685	85	4,1	2	1575
PL3U17L15C	47	2835 SMD	PCB	4915	2700 - 6500	57	1973	85	4,7	2	1250
PL3U17L15CSB	47	2835 SMD	PCB	4915	2700 - 6500	57	1969	85	4,7	2	1250
PL3U17L15CSO	47	2835 SMD	PCB	4915	2700 - 6500	57	1965	85	4,7	2	1250
PL3U17L25C	70	2835 SMD	PCB	7370	2700 - 6500	57	1973	85	4,7	2	1250
PL3U17L25CSB	70	2835 SMD	PCB	7370	2700 - 6500	57	1969	85	4,7	2	1250
PL3U17L25CSO	70	2835 SMD	PCB	7370	2700 - 6500	57	1965	85	4,7	2	1250
PL3U18L15C	53	2835 SMD	PCB	5615	2700 - 6500	57	2254	85	5,3	2	1250
PL3U18L15CSB	53	2835 SMD	PCB	5615	2700 - 6500	57	2250	85	5,3	2	1250
PL3U18L15CSO	53	2835 SMD	PCB	5615	2700 - 6500	57	2246	85	5,3	2	1250
PL3U19L15C	60	2835 SMD	PCB	6320	2700 - 6500	57	2534	85	5,9	2	1250
PL3U19L15CSB	60	2835 SMD	PCB	6320	2700 - 6500	57	2530	85	5,9	2	1250
PL3U19L15CSO	60	2835 SMD	PCB	6320	2700 - 6500	57	2526	85	5,9	2	1250
PL3U10L15C	66	2835 SMD	PCB	7020	2700 - 6500	57	2815	85	6,5	2	1000
PL3U10L15CSB	66	2835 SMD	PCB	7020	2700 - 6500	57	2811	85	6,5	2	1000
PL3U10L15CSO	66	2835 SMD	PCB	7020	2700 - 6500	57	2807	85	6,5	2	1000

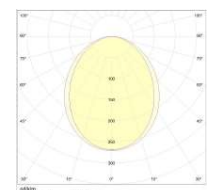
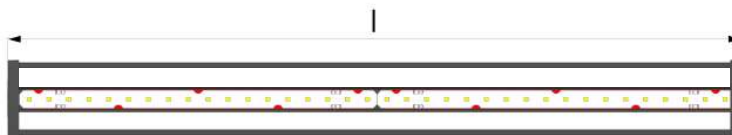
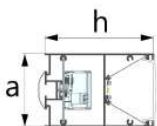



 **pamir**[®]
lighting





ELEGANT



ELEGANT

LED

Suspended 1X Lighting Fixtures With Frosted Diffuser

Luminaire Suspendus 1X Avec Diffuseur Givré

APPLICATION AREAS

Offices
Meeting rooms
Stores
Hospitals
Schools
Corridors

DOMAINES D'UTILISATION

Bureaux
Salles de Réunion
Magasins
Hopitaux
Ecoles
Couloirs

BODY

Anodized aluminum with satin finishing. Bronze, silver and white color options with thin (37mm) elegant design.

DIFFUSER

UV stabilized prismatic diffuser.

CONVERTER

Long life, low power loss converter with constant current. Compatible with ENEC standards.

LED

LED modules with 60.000 hours lifetime LUMILEDS / SAMSUNG / NICHIA brand LEDs.

SUSPENSION

Composed of 1mm steel wire rope and nickel-plated brass components. Suspension height is adjustable. Supplied with transparent electric cord and ceiling mounted electrical junction box with aesthetic design.

CORPS

Corps en aluminium anodisé, satiné. Design élégant. Couleurs argent, bronze et blanc disponibles. Epaisseur 37 mm.

DIFFUSEUR

Diffuseur prismatique. Anti UV.

CONVERTEUR

Convertisseur, conforme aux normes ENEC. Longue vie. Perte de puissance faible avec courant constant.

LED

Modules LED – Durée de vie 60.000 heures avec LED de marque LUMILEDS / SAMSUNG / NICHIA.

SYSTEME DE FIXATION

Composé d'un fil en acier de 1mm, de composants en laiton nickelés. Livré avec un cordon électrique transparent et une boîte de jonction électrique à fixer au plafond. Hauteur de fixation réglable.

**Color Options
Options de Couleur**

White
Blanc
Silver
Argent
Bronz
Bronze



LED Type / Type LED

Color Rendering Index / Indice de Rendu des Couleurs: (CRI): Ra>80

Code	Power Puissance (W)	LED Type Type De LED	LED Module Module LED	Lum. Flux Flux Lum. (lm)	Color Temperature Température De Couleur (K)	Dimensions (mm)			Weight Poids (kg)	Packing Quantity Colisage	Pcs./20" Container Pcs./20" Conteneur
						a	b	h			
PL1S11L15C	8	2835 SMD	PCB	655	2700 - 6500	165	418	37	1.2	2	4414
PL1S12L15C	14	2835 SMD	PCB	1310	2700 - 6500	165	699	37	1.9	2	2766
PL1S13L15C	21	2835 SMD	PCB	1970	2700 - 6500	165	980	37	2.6	2	2014
PL1S14L15C	26	2835 SMD	PCB	2620	2700 - 6500	165	1260	37	3.4	2	1572
PL1S15L15C	33	2835 SMD	PCB	3280	2700 - 6500	165	1540	37	4.1	2	1296

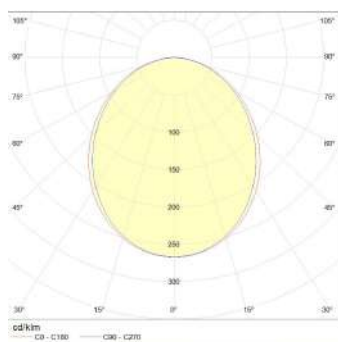
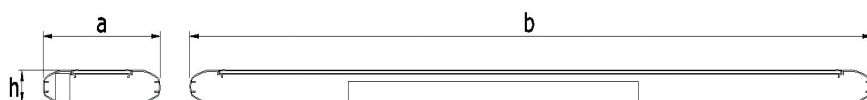

V / Hz 220 - 240 / 50 - 60

Options	Options
Dimmable electronic ballast or convertor.	Ballast électronique dimmable ou converteur.
Emergency kit	Kit d'urgence.

NOTE	NOTE
Given lumen values are net delivered luminaire output lumens.	Les valeurs de lumens données sont les lumens de sortie nets du luminaire.
Given power values are total consumed AC power of the luminaire.	Les valeurs de puissance données sont la puissance AC totale consommée du luminaire.



ELEGANT

LED

Suspended 2X Lighting Fixtures With Frosted Diffuser

Luminaire Suspendus 2X Avec Diffuseur Givré

APPLICATION AREAS

Offices
Meeting rooms
Stores
Hospitals
Schools
Corridors

DOMAINES D'UTILISATION

Bureaux
Salles de Réunion
Magasins
Hopitaux
Ecoles
Couloirs

BODY

Anodized aluminum with satin finishing. Bronze, silver and white color options with thin (37mm) elegant design.

DIFFUSER

UV stabilized prismatic diffuser.

CONVERTER

Long life, low power loss converter with constant current. Compatible with ENEC standards.

LED

LED modules with 60.000 hours lifetime LUMILEDS / SAMSUNG / NICHIA brand LEDs.

SUSPENSION

Composed of 1mm steel wire rope and nickel-plated brass components. Suspension height is adjustable. Supplied with transparent electric cord and ceiling mounted electrical junction box with aesthetic design.

CORPS

Corps en aluminium anodisé, satiné. Design élégant. Couleurs argent, bronze et blanc disponibles. Epaisseur 37 mm.

DIFFUSEUR

Diffuseur prismatique. Anti UV.

CONVERTEUR

Convertisseur, conforme aux normes ENEC. Longue vie. Perte de puissance faible avec courant constant.

LED

Modules LED – Durée de vie 60.000 heures avec LED de marque LUMILEDS / SAMSUNG / NICHIA.

SYSTEME DE FIXATION

Composé d'un fil en acier de 1mm, de composants en laiton nickelés. Livré avec un cordon électrique transparent et une boîte de jonction électrique à fixer au plafond. Hauteur de fixation réglable.

Color Options
Options de Couleur

White
Blanc
Silver
Argent
Bronz
Bronze



LED Type / Type LED

Color Rendering Index / Indice de Rendu des Couleurs: (CRI): Ra>80

Code	Power Puissance (W)	LED Type Type De LED	LED Module Module LED	Lum. Flux Flux Lum. (lm)	Color Temperature Température De Couleur (K)	Dimensions (mm)			Weight Poids (kg)	Packing Quantity Colisage	Pcs./20" Container Pcs./20" Conteneur
						a	b	h			
PL1S21L15C	14	2835 SMD	PCB	1310	2700 - 6500	287	418	37	2.2	2	2856
PL1S22L15C	26	2835 SMD	PCB	2620	2700 - 6500	287	699	37	3.3	2	1790
PL1S23L15C	39	2835 SMD	PCB	3930	2700 - 6500	287	980	37	4.3	2	1300
PL1S24L15C	53	2835 SMD	PCB	5245	2700 - 6500	287	1260	37	5.4	2	1020
PL1S25L15C	66	2835 SMD	PCB	6555	2700 - 6500	287	1540	37	6.7	2	844

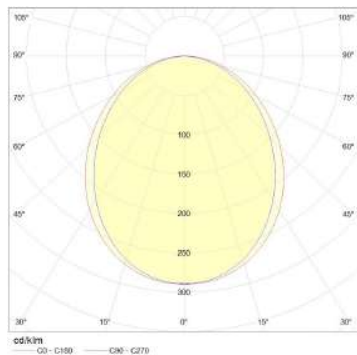
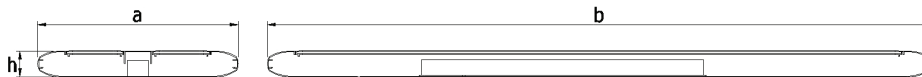

V / Hz | 220 - 240 / 50 - 60

Options	Options
Dimmable electronic ballast or convertor. Emergency kit	Ballast électronique dimmable ou convertor. Kit d'urgence.
NOTE	NOTE
Given lumen values are net delivered luminaire output lumens.	Les valeurs de lumens données sont les lumens de sortie nets du luminaire.
Given power values are total consumed AC power of the luminaire.	Les valeurs de puissance données sont la puissance AC totale consommée du luminaire.



ELEGANT

LED

Surface Mounted 4X Lighting Fixtures With Frosted Diffuser

Luminaire Apparents 4X Avec Diffuseur Givré

APPLICATION AREAS

Offices
Meeting rooms
Stores
Hospitals
Schools
Corridors

DOMAINES D'UTILISATION

Bureaux
Salles de Réunion
Magasins
Hopitaux
Ecoles
Couloirs

BODY

Anodized aluminum with satin finishing. Bronze, silver and white color options with thin (37mm) elegant design.

DIFFUSER

UV stabilized prismatic diffuser.

CONVERTER

Long life, low power loss converter with constant current. Compatible with ENEC standards.

LED

LED modules with 60.000 hours lifetime LUMILEDS / SAMSUNG / NICHIA brand LEDs.

CORPS

Corps en aluminium anodisé, satiné. Design élégant. Couleurs argent, bronze et blanc disponibles. Epaisseur 37 mm.

DIFFUSEUR

Diffuseur prismatique. Anti UV.

CONVERTEUR

Convertisseur, conforme aux normes ENEC. Longue vie. Perte de puissance faible avec courant constant.

LED

Modules LED – Durée de vie 60.000 heures avec LED de marque LUMILEDS / SAMSUNG / NICHIA.

Color Options
Options de Couleur

White
Blanc
Silver
Argent
Bronz
Bronze



LED Type / Type LED

Color Rendering Index / Indice de Rendu des Couleurs: (CRI): Ra>80

Code	Power Puissance (W)	LED Type Type De LED	LED Module Module LED	Lum. Flux Flux Lum. (lm)	Color Temperature Température de Couleur (K)	Dimensions (mm)			Weight Poids (kg)	Packing Quantity Colisage	Pcs./20" Container Pcs./20" Conteneur
						a	b	h			
PL1U42L15C	53	2835 SMD	PCB	5245	2700 - 6500	486	692	37	5.2	2	1126
PL1U43L15C	79	2835 SMD	PCB	7870	2700 - 6500	486	973	37	7.0	2	820
PL1U44L15C	105	2835 SMD	PCB	10490	2700 - 6500	486	1254	37	8.7	2	644
PL1U45L15C	132	2835 SMD	PCB	13110	2700 - 6500	486	1535	37	10.5	2	530

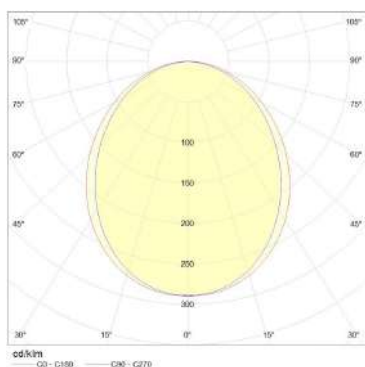
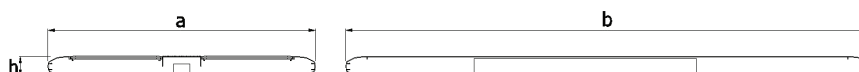

V / Hz 220 - 240 / 50 - 60

Options	Options
Dimmable electronic ballast or convertor. Emergency kit	Ballast électronique dimmable ou converteur. Kit d'urgence.

NOTE	NOTE
Given lumen values are net delivered luminaire output lumens.	Les valeurs de lumens données sont les lumens de sortie nets du luminaire.
Given power values are total consumed AC power of the luminaire.	Les valeurs de puissance données sont la puissance AC totale consommée du luminaire.



 **pamir**[®]
aydınlıkta

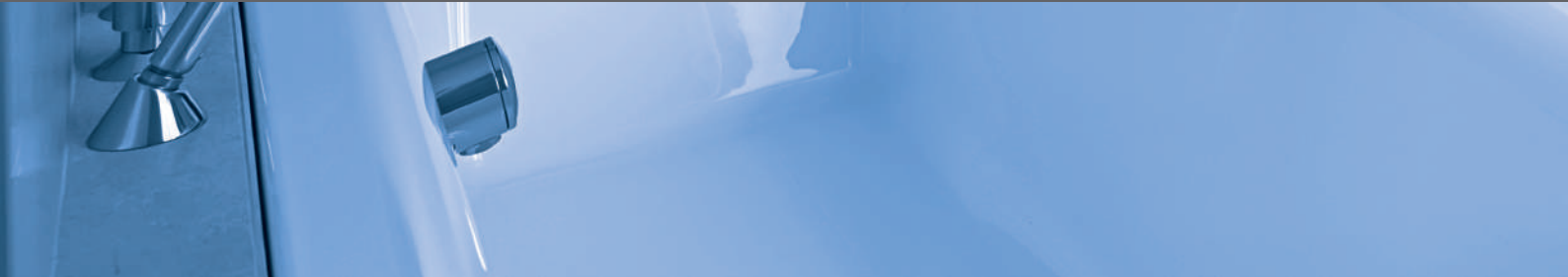



APPLIQUE



APLIK / APPLIQUE

LED

Mirror Type Applique Lighting Fixtures With Frosted Diffuser

Applique Pour Miroir Avec Diffuseur Givré

BODY

Anodized aluminum with satin finishing. Black, white and silver color options with elegant design.

DIFFUSER

UV stabilized frosted diffuser.

CONVERTER

Long life, low power loss converter with constant current. Compatible with ENEC standards.

LED

LED modules with 60.000 hours lifetime LUMILEDS / SAMSUNG / NICHIA brand LEDs.

APPLICATION AREAS

Washbasins
Bathrooms
Offices
Meeting rooms
Stores
Hospitals
Schools
Corridors

DOMAINES D'UTILISATION

Lavabos
Salles de Bain
Bureaux
Salles de Réunions
Magasins
Hopitaux
Ecoles
Couloirs

CORPS

Corps en aluminium anodisé, satiné. Design élégant. Couleurs blanc, argent, noir disponibles.

DIFFUSEUR

Diffuseur givré. Anti UV.

CONVERTEUR

Convertisseur, conforme aux normes ENEC. Longue vie. Perte de puissance faible avec courant constant.

LED

Modules LED – Durée de vie 60.000 heures avec LED de marque LUMILEDS / SAMSUNG / NICHIA.

Color Options
Options de Couleur



LED Type / Type LED

Color Rendering Index / Indice de Rendu des Couleurs: (CRI): Ra>80

Code	Power Puissance (W)	LED Type Type De LED	LED Module Module LED	Lum. Flux Flux Lum. (lm)	Color Temperature Température De Couleur (K)	Dimensions (mm)			Weight Poids (kg)	Packing Quantity Colisage	Pcs./20" Container Pcs./20" Conteneur
						a	b	h			
PL5U11L15C	8	2835 SMD	PCB	675	2700 - 6500	104	340	60	1.3	2	5620
PL5U12L15C	14	2835 SMD	PCB	1350	2700 - 6500	104	620	60	1.7	2	3120
PL5U13L15C	21	2835 SMD	PCB	2025	2700 - 6500	104	900	60	2.0	2	1454
PL5U14L15C	26	2835 SMD	PCB	2700	2700 - 6500	104	1181	60	2.4	2	1134

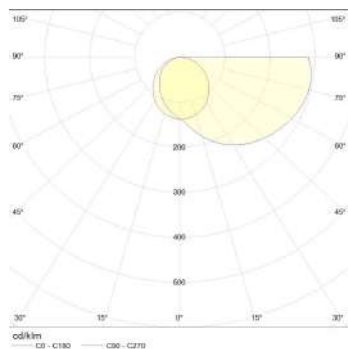

V / Hz 220 - 240 / 50 - 60

Options Dimmable electronic ballast or convertor. Emergency kit	Options Ballast électronique dimmable ou converteur. Kit d'urgence.
NOTE Given lumen values are net delivered luminaire output lumens. Given power values are total consumed AC power of the luminaire.	NOTE Les valeurs de lumens données sont les lumens de sortie nets du luminaire. Les valeurs de puissance données sont la puissance AC totale consommée du luminaire.



APLIK / APPLIQUE

LED

Kitchen Type Applique Lighting

Fixture With Frosted Diffuser

Applique Pour Cuisine Avec Diffuseur Givré

APPLICATION AREAS

Under Kitchen Cabinets
Under Shelves
Shopping Malls
Supermarkets
Offices
Meeting rooms
Stores
Hospitals
Schools
Corridors

DOMAINES D'UTILISATION

Sous Placards de Cuisine
Sous Etagerés
Centres Commerciaux
Supermarchés
Bureaux
Salles de Réunions
Magasins
Hopitaux
Ecoles
Couloirs

BODY

Anodized aluminum with satin finishing. Black, white and silver color options with elegant design.

DIFFUSER

UV stabilized frosted diffuser.

CONVERTER

Long life, low power loss converter with constant current. Compatible with ENEC standards.

LED

LED modules with 60.000 hours lifetime LUMILEDS / SAMSUNG / NICHIA brand LEDs.

CORPS

Corps en aluminium anodisé, satiné. Design élégant. Couleurs blanc, argent, noir disponibles.

DIFFUSEUR

Diffuseur givré. Anti UV.

CONVERTEUR

Convertisseur, conforme aux normes ENEC. Longue vie. Perte de puissance faible avec courant constant.

LED

Modules LED – Durée de vie 60.000 heures avec LED de marque LUMILEDS / SAMSUNG / NICHIA.

Color Options
Options de Couleur



LED Type / Type LED

Color Rendering Index / Indice de Rendu des Couleurs: (CRI): Ra>80

Code	Power Puissance (W)	LED Type Type De LED	LED Module Module LED	Lum. Flux Flux Lum. (lm)	Color Temperature Température De Couleur (K)	Dimensions (mm)			Weight Poids (kg)	Packing Quantity Colisage	Pcs./20" Container Pcs./20" Conteneur
						a	l	h			
PL9U11L15CP	8	2835 SMD	PCB	550	2700 - 6500	93	335	63	0,7	2	5890
PL9U12L15CP	14	2835 SMD	PCB	1105	2700 - 6500	93	616	63	1,8	2	3310
PL9U13L15CP	21	2835 SMD	PCB	1655	2700 - 6500	93	897	63	2,3	2	1454
PL9U14L15CP	26	2835 SMD	PCB	2205	2700 - 6500	93	1178	63	2,8	2	1134
PL9U15L15CP	33	2835 SMD	PCB	2755	2700 - 6500	93	1459	63	3,3	2	918

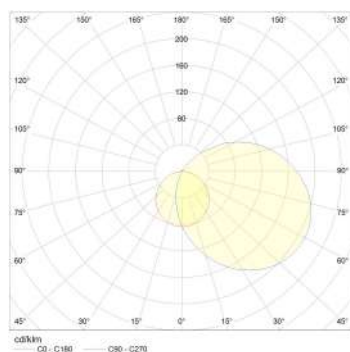
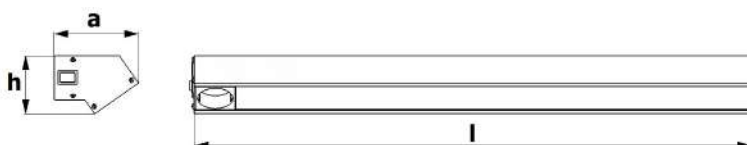

V / Hz 220 - 240 / 50 - 60

Options Dimmable electronic ballast or convertor. Emergency kit	Options Ballast électronique dimmable ou converteur. Kit d'urgence.
NOTE Given lumen values are net delivered luminaire output lumens. Given power values are total consumed AC power of the luminaire.	NOTE Les valeurs de lumens données sont les lumens de sortie nets du luminaire. Les valeurs de puissance données sont la puissance AC totale consommée du luminaire.

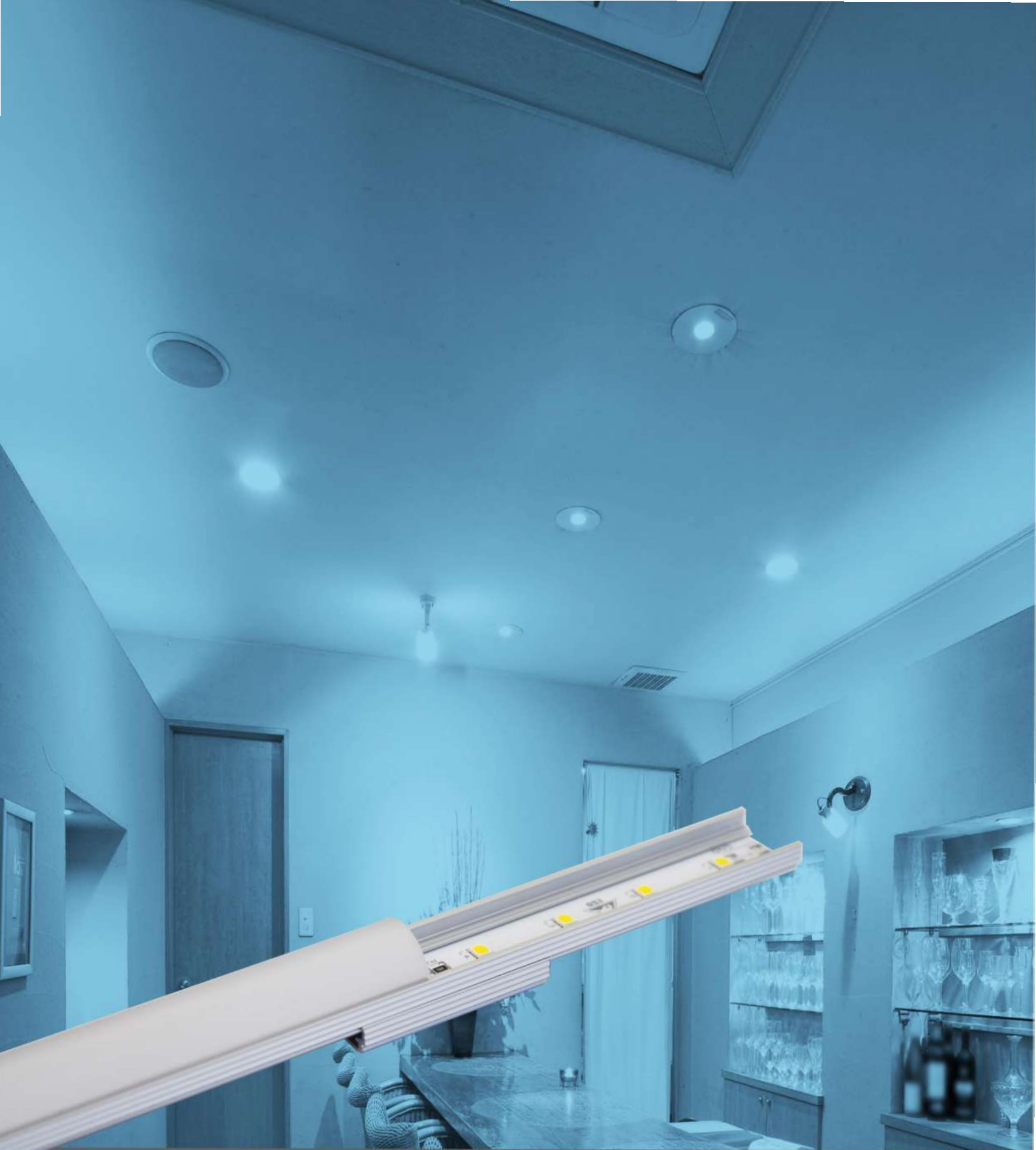

 **pamir**[®]
aydinlatma





COVE LIGHTING



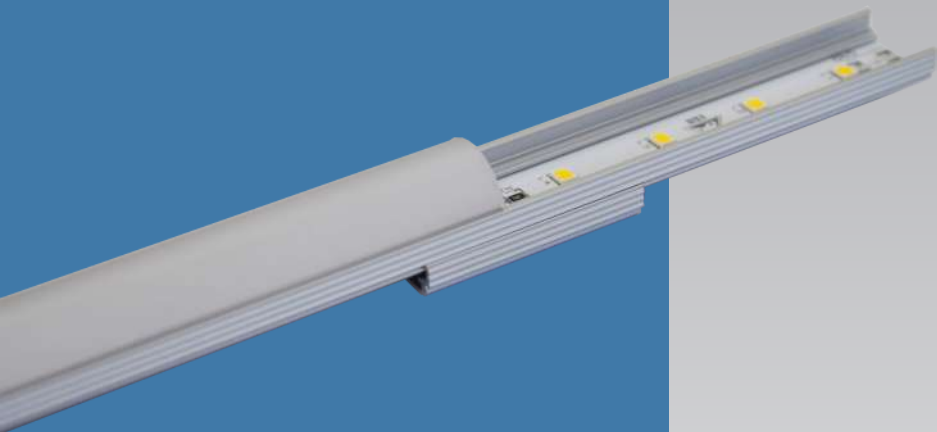

COVE LIGHTING

LED

Aluminum Profile Cove Lighting
Fixtures With Diffuser

Appareils D'éclairage De Crique De
Profil En Aluminium Avec Diffuseur

APPLICATION AREAS

Under Kitchen Cabinets
Under Shelves
Shopping Malls
Supermarkets
Offices
Meeting rooms
Stores
Hospitals
Schools
Corridors

DOMAINES D'UTILISATION

Sous Placards de Cuisine
Sous Etagères
Centres Commerciaux
Supermarchés
Bureaux
Salles de Réunions
Magasins
Hopitaux
Ecoles
Couloirs

BODY

Matt natural anodized, aluminum extrusion profile. With mounting accessories and plastic end cap.

DIFFUSER

UV stabilized frosted diffuser.

LED

24V constant voltage LED modules with 60.000 hours lifetime SEOUL brand LEDs.

CORPS

Profilé d'extrusion en aluminium anodisé naturel mat. Avec accessoires de montage et embout en plastique.

DIFFUSEUR

Diffuseur givré. Anti UV.

LED

Modules LED 24V tension constante – Durée de vie 60.000 heures avec LED de marque SEOUL.

Color Options
Options de Couleur



LED Type / Type LED

Color Rendering Index / Indice de Rendu des Couleurs: (CRI): Ra>80

Code	Power Puissance (W)	LED Type Type De LED	LED Module Module LED	Lum. Flux Flux Lum. (lm)	Color Temperature Température De Couleur (K)	Dimensions (mm)			Weight Poids (kg)	Packing Quantity Colisage	Pcs./20" Container Pcs./20" Conteneur
						a	l	h			
PL20U2415	17/m	2835 SMD	PCB	1475/m	2700 - 6500	17	1000	23	1.9	2	130860

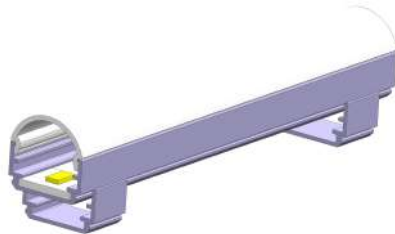
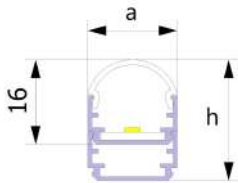

V / Hz 220 - 240 / 50 - 60

NOTE	NOTE
This product is produced in lengths multiples of 125 mm.	Ce produit est fabriqué en longueurs multiples de 125 mm.

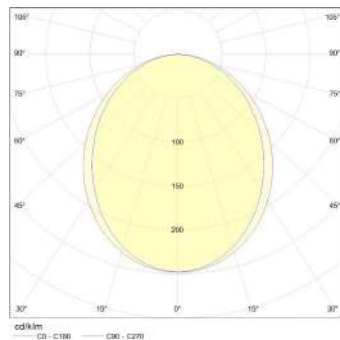

Options	Options
Dimmable electronic ballast or convertor.	Ballast électronique dimmable ou converteur.
Emergency kit	Kit d'urgence.

NOTE	NOTE
Given lumen values are net delivered luminaire output lumens.	Les valeurs de lumens données sont les lumens de sortie nets du luminaire.
Given power values are total consumed AC power of the luminaire.	Les valeurs de puissance données sont la puissance AC totale consommée du luminaire.



 **pamir**[®]
aydınlıkta



QUADRO



QUADRO

LED (GU-10)

Honeycomb Ceiling Lighting Fixtures

Luminaire de Plafond en Nid D'abeille

APPLICATION AREAS

Shopping Malls
Supermarkets
Offices
Meeting rooms
Living Rooms
Waiting Rooms
Stores
Hospitals
Schools
Corridors

DOMAINES D'UTILISATION

Centres Commerciaux
Supermarchés
Bureaux
Salles de Réunions
Salles de Séjour
Salles D'attente
Magasins
Hopitaux
Ecoles
Couloirs

BODY

0.70mm thick DKP metal sheet body.

COLOR

Black body as standard. As an option, it can be produced in ceiling color.

SUPPLY

220V AC supply, easy connection with push-in terminal block.

LED

20.000 hours lifetime LED Bulb with GU-10 lampholder.

CORPS

Corps en tôle DKP de 0,70 mm d'épaisseur.

COULEUR

Corps noir en standard. En option, il peut être réalisé en couleur plafond.

D'ALIMENTATION

Alimentation 220V AC, raccordement facile avec bornier push-in.

LED

Ampoule LED d'une durée de vie de 20 000 heures avec douille GU-10.

Color Options
Options de Couleur



LED Type / Type LED

Color Rendering Index / Indice de Rendu des Couleurs: (CRI): Ra > 80

Code	Power Puissance (W)	LED Type Type De LED	LED Module Module LED	Lum. Flux Flux Lum. (lm)	Color Temperature Température De Couleur (K)	Dimensions (mm)			Packing Quantity Colisage	Pcs./20" Container Pcs./20" Conteneur
						a	b	h		
PL19A11Q8	4	GU-10	SMD	340	3000 - 6500	100	100	76	1	15600
PL19A11Q10	4	GU-10	SMD	340	3000 - 6500	119	119	76	1	12000
PL19A12Q8	8	GU-10	SMD	680	3000 - 6500	200	100	76	1	9000
PL19A12Q10	8	GU-10	SMD	680	3000 - 6500	237	119	76	1	6900
PL19A22Q8	16	GU-10	SMD	1360	3000 - 6500	200	200	76	1	5100
PL19A22Q10	16	GU-10	SMD	1360	3000 - 6500	237	237	76	1	4000

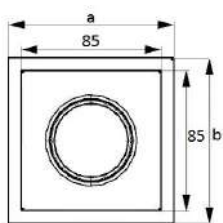

PL19A11Q8

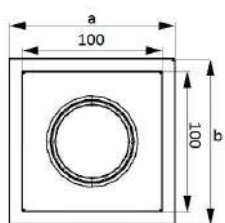

PL19A11Q10

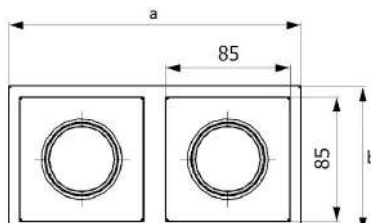

PL19A12Q8

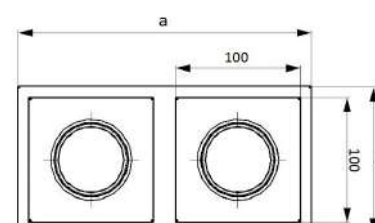

PL19A12Q10

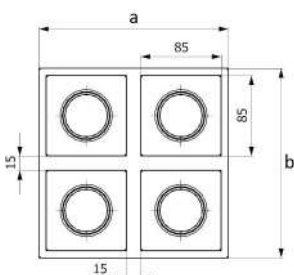

PL19A22Q8

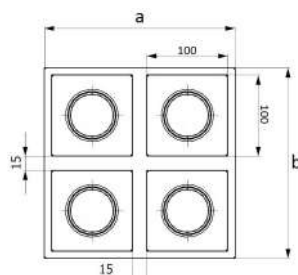

PL19A22Q10

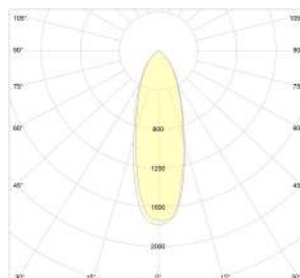

V / Hz 220 - 240 / 50 - 60

NOTE	NOTE
Given lumen values are net delivered luminaire output lumens.	Les valeurs de lumens données sont les lumens de sortie nets du luminaire.
Given power values are total consumed AC power of the luminaire.	Les valeurs de puissance données sont la puissance AC totale consommée du luminaire.

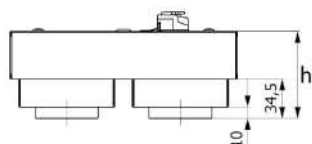





SURFACE MOUNTED



SURFACE BACK LIGHT

LED

Surface Mounted Lighting Fixtures With Frosted Diffuser

Luminaire Apparents Avec Diffuseur Givré

APPLICATION AREAS

Shopping Malls
Supermarkets
Offices
Meeting rooms
Stores
Hospitals
Schools
Corridors

DOMAINES D'UTILISATION

Centres Commerciaux
Supermarchés
Bureaux
Salles de Réunions
Magasins
Hopitaux
Ecoles
Couloirs

BODY

Electrostatic powder coated sheetmetal.

DIFFUSER

UV stabilized frosted diffuser.

CONVERTER

Long life, low power loss converter with constant current.
Compatible with ENEC standards.

LED

LED modules with 60.000 hours lifetime LUMILEDS / SAMSUNG / NICHIA / SEOUL brand LEDs.

CORPS

Feuille de métal peinte électrostatiquement.

DIFFUSEUR

Diffuseur givré. Anti UV.

CONVERTEUR

Convertisseur, conforme aux normes ENEC. Longue vie. Perte de puissance faible avec courant constant .

LED

Modules LED – Durée de vie 60.000 heures avec LED de marque LUMILEDS / SAMSUNG / NICHIA / SEOUL.



LED Type / Type LED

Color Rendering Index / Indice de Rendu des Couleurs: (CRI): Ra>80

Code	Power Puissance (W)	LED Type Type De LED	LED Module Module LED	Lum. Flux Flux Lum. (lm)	Color Temperature Température De Couleur (K)	Dimensions (mm)			Weight Poids (kg)	Packing Quantity Colisage	Pcs./20" Container Pcs./20" Conteneur
						a	b	h			
PL11U11E06C	14	2835 SMD	PCB	1530	2700 - 6500	300	300	64	2.0	4	2600
PL11U12E04C	14	2835 SMD	PCB	2250	2700 - 6500	300	600	64	3.0	2	1318
PL11U12E05C	20	2835 SMD	PCB	3010	2700 - 6500	300	600	64	3.0	2	1318
PL11U14E04C	29	2835 SMD	PCB	4055	2700 - 6500	300	1200	64	4.6	2	680
PL11U14E05C	42	2835 SMD	PCB	4590	2700 - 6500	300	1200	64	4.6	2	680
PL11U22E04C	36	2835 SMD	PCB	4055	2700 - 6500	600	600	64	3.5	2	700
PL11U22E05C	42	2835 SMD	PCB	4590	2700 - 6500	600	600	64	3.5	2	700
PL11U22E06C	56	2835 SMD	PCB	5790	2700 - 6500	600	600	64	3.5	2	700
PL11U24E04C	72	2835 SMD	PCB	7065	2700 - 6500	600	1200	64	7.0	2	360
PL11U24E05C	84	2835 SMD	PCB	8005	2700 - 6500	600	1200	64	7.0	2	360
PL11U24E06C	112	2835 SMD	PCB	10095	2700 - 6500	600	1200	64	7.0	2	360

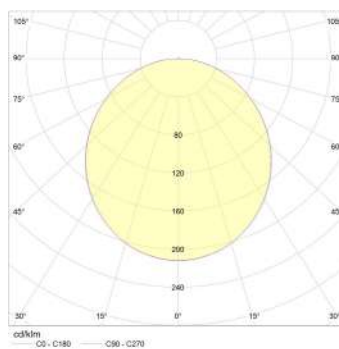
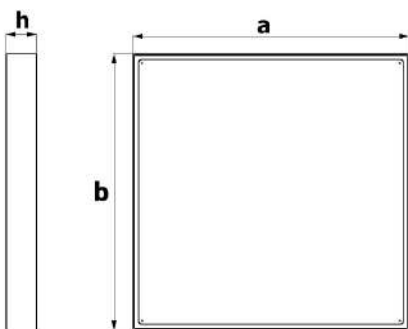

V / Hz 220 - 240 / 50 - 60

Options	Options
Dimmable electronic ballast or convertor.	Ballast électronique dimmable ou converteur.
Emergency kit	Kit d'urgence.

NOTE	NOTE
Given lumen values are net delivered luminaire output lumens.	Les valeurs de lumens données sont les lumens de sortie nets du luminaire.
Given power values are total consumed AC power of the luminaire.	Les valeurs de puissance données sont la puissance AC totale consommée du luminaire.



 **pamir**[®]
aydınlatma



**STERILE
STÉRILE**



STERILE

LED

Recessed Lighting Fixtures With Frosted Diffuser

Luminaire Encastrés Avec Diffuseur Givré

APPLICATION AREAS

Patient Rooms
Surgery Rooms
Consulting Rooms

DOMAINES D'UTILISATION

Chambres Des Patients
Salles d'Opération
Salles de Consultation

BODY

Electrostatic powder coated sheetmetal.

DIFFUSER

UV stabilized frosted diffuser.

CONVERTER

Long life, low power loss converter with constant current.
Compatible with ENEC standards.

LED

LED modules with 60.000 hours lifetime LUMILEDS / SAMSUNG / NICHIA / SEOUL brand LEDs.

SEAL

Thermoplastic elastomer.

GLASS

4mm tempered glass (with certificate).

CORPS

Feuille de métal peinte électrostatiquement.

DIFFUSEUR

Diffuseur givré. Anti UV.

CONVERTEUR

Convertisseur, conforme aux normes ENEC. Longue vie. Perte de puissance faible avec courant constant.

LED

Modules LED – Durée de vie 60.000 heures avec LED de marque LUMILEDS / SAMSUNG / NICHIA / SEOUL.

JOINT

Elastomère thermoplastique.

VERRE

4 mm verre trempé (avec certificat).

Ceiling Mounting System
Système de Montage au Plafond

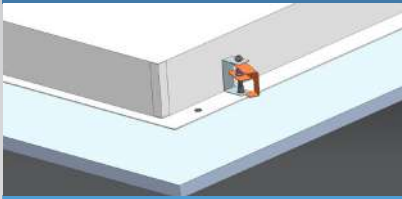

LED Type / Type LED

Color Rendering Index / Indice de Rendu des Couleurs: (CRI): Ra>80

Code	Power Puissance (W)	LED Type Type De LED	LED Module Module LED	Lum. Flux Flux Lum. (lm)	Color Temperature Température De Couleur (K)	Dimensions (mm)					Weight Poids (kg)	Packing Quantity Colisage	Pcs./20" Container Pcs./20" Conteneur
						a1	a2	b1	b2	h			
PL12A11E06C	14	2835 SMD	PCB/350	1335	2700 - 6500	316	290	316	290	85	2.5	2	2596
PL12A12E04C	14	2835 SMD	PCB/350	1960	2700 - 6500	316	290	616	590	85	3.5	2	1318
PL12A12E05C	20	2835 SMD	PCB/500	2230	2700 - 6500	316	290	616	590	85	3.5	2	1318
PL12A13E04C	22	2835 SMD	PCB/350	2110	2700 - 6500	316	290	916	890	85	4.5	2	1100
PL12A13E05C	32	2835 SMD	PCB/500	3070	2700 - 6500	316	290	916	890	85	4.5	2	1100
PL12A14E04C	29	2835 SMD	PCB/350	2790	2700 - 6500	316	290	1216	1190	85	6.5	2	600
PL12A14E05C	42	2835 SMD	PCB/500	4040	2700 - 6500	316	290	1216	1190	85	6.5	2	600
PL12A22E04C	36	2835 SMD	PCB/900	3530	2700 - 6500	616	590	616	590	85	8.0	2	650
PL12A22E05C	42	2835 SMD	PCB/1050	4000	2700 - 6500	616	590	616	590	85	8.0	2	650
PL12A22E06C	56	2835 SMD	PCB/1400	5045	2700 - 6500	616	590	616	590	85	8.0	2	650
PL12A24E04C	72	2835 SMD	PCB/900	6150	2700 - 6500	616	590	1165	1140	85	16.0	1	250
PL12A24E05C	84	2835 SMD	PCB/1050	6960	2700 - 6500	616	590	1165	1140	85	16.0	1	250
PL12A24E06C	112	2835 SMD	PCB/1400	8780	2700 - 6500	616	590	1165	1140	85	16.0	1	250

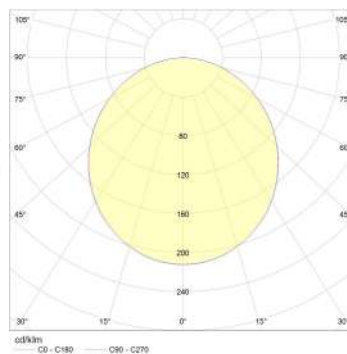
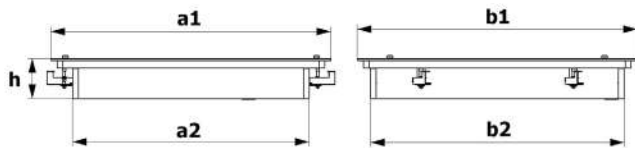

V / Hz 220 - 240 / 50 - 60

Options	Options
Dimmable electronic ballast or convertor. Emergency kit	Ballast électronique dimmable ou converteur. Kit d'urgence.
NOTE	NOTE
Given lumen values are net delivered luminaire output lumens.	Les valeurs de lumens données sont les lumens de sortie nets du luminaire.
Given power values are total consumed AC power of the luminaire.	Les valeurs de puissance données sont la puissance AC totale consommée du luminaire.



STERILE INDIRECT

LED

Recessed Lighting Fixtures With Frosted Diffuser

Luminaire Encastrés Avec Diffuseur Givré

APPLICATION AREAS

Patient Rooms
Surgery Rooms
Consulting Rooms

DOMAINES D'UTILISATION

Chambres Des Patients
Salles d'Opération
Salles de Consultation

BODY

Electrostatic powder coated sheetmetal.

DIFFUSER

UV stabilized frosted diffuser.

CONVERTER

Long life, low power loss converter with constant current.
Compatible with ENEC standards.

LED

LED modules with 60.000 hours lifetime LUMILEDS / SAMSUNG / NICHIA / SEOUL brand LEDs.

SEAL

Thermoplastic elastomer.

GLASS

4mm tempered glass (with certificate)

CORPS

Feuille de métal peinte électrostatiquement.

DIFFUSEUR

Diffuseur givré. Anti UV.

CONVERTEUR

Convertisseur, conforme aux normes ENEC. Longue vie. Perte de puissance faible avec courant constant.

LED

Modules LED – Durée de vie 60.000 heures avec LED de marque LUMILEDS / SAMSUNG / NICHIA / SEOUL.

JOINT

Elastomère thermoplastique.

VERRE

4 mm verre trempé (avec certificat)

Ceiling Mounting System
Système de Montage au Plafond

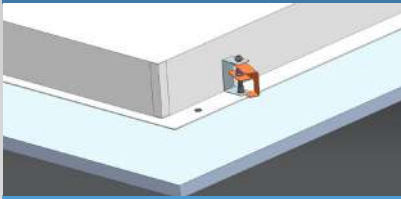

LED Type / Type LED

Color Rendering Index / Indice de Rendu des Couleurs: (CRI): Ra>80

Code	Power Puissance (W)	LED Type Type De LED	LED Module Module LED	Lum. Flux Flux Lum. (lm)	Color Temperature Température De Couleur (K)	Dimensions (mm)					Weight Poids (kg)	Packing Quantity Colisage	Pcs./20" Container Pcs./20" Conteneur
						a1	a2	b1	b2	h			
PL12EA22L15C	26	2835 SMD	PCB	2450	2700 - 6500	616	595	616	595	85	8.5	2	700
PL12EA22L25C	41	2835 SMD	PCB	3665	2700 - 6500	616	595	616	595	85	8.6	2	700

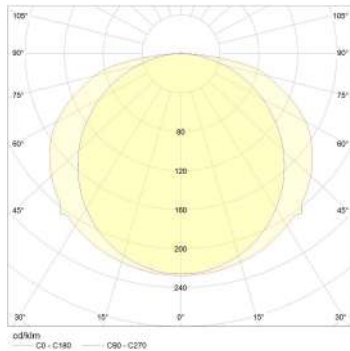
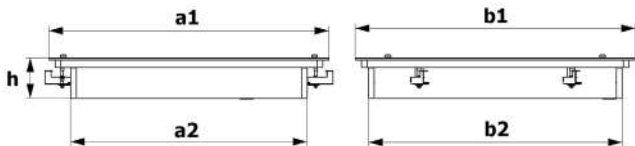

V / Hz 220 - 240 / 50 - 60

Options	Options
Dimmable electronic ballast or convertor. Emergency kit	Ballast électronique dimmable ou converteur. Kit d'urgence.
NOTE	NOTE
Given lumen values are net delivered luminaire output lumens.	Les valeurs de lumens données sont les lumens de sortie nets du luminaire.
Given power values are total consumed AC power of the luminaire.	Les valeurs de puissance données sont la puissance AC totale consommée du luminaire.



 **pamir**[®]
aydınlıq



RECESSED / ENCASTRE

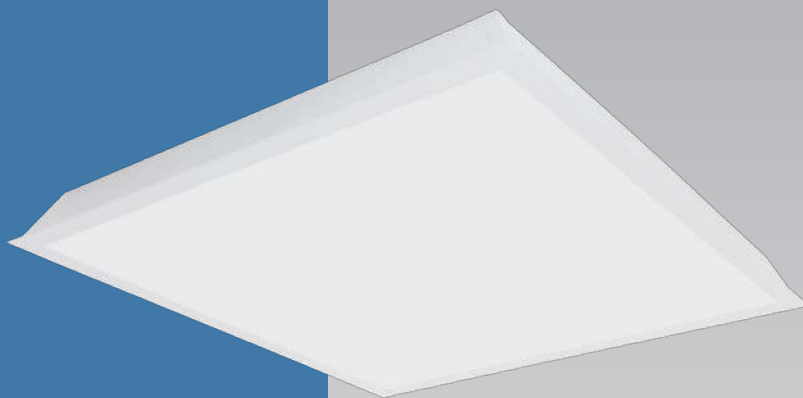

RECESSED BACK LIGHT T BAR CEILING

LED

Lighting Fixtures With Frosted Diffuser

Luminaire Avec Diffuseur Givré

APPLICATION AREAS

Offices
Meeting rooms
Stores
Hospitals
Schools
Corridors

DOMAINES D'UTILISATION

Bureaux
Salles de Réunion
Magasins
Hopitaux
Ecoles
Couloirs

BODY

Electrostatic powder coated sheetmetal.

DIFFUSER

UV stabilized frosted diffuser.

CONVERTER

Long life, low power loss converter with constant current.
Compatible with ENEC standards.

LED

LED modules with 60.000 hours lifetime LUMILEDS /
SAMSUNG / NICHIA / SEOUL brand LEDs.

CORPS

Feuille de métal peinte électrostatiquement.

DIFFUSEUR

Diffuseur givré. Anti UV.

CONVERTEUR

Convertisseur, conforme aux normes ENEC. Longue vie. Perte de puissance faible avec courant constant .

LED

Modules LED – Durée de vie 60.000 heures avec LED de marque LUMILEDS / SAMSUNG / NICHIA / SEOUL.

Ceiling Mounting System
Système de Montage au Plafond



LED Type / Type LED

Color Rendering Index / Indice de Rendu des Couleurs: (CRI): Ra>80

Code	Power Puissance (W)	LED Type Type De LED	LED Module Module LED	Lum. Flux Flux Lum. (lm)	Color Temperature Température De Couleur (K)	Dimensions (mm)					Weight Poids (kg)	Packing Quantity Colisage	Pcs./20" Container Pcs./20" Conteneur
						a1	a2	b1	b2	h			
PL11A11E06C	14	2835 SMD	PCB	1500	2700 - 6500	293	268	293	268	60	1.5	2	2596
PL11A12E04C	14	2835 SMD	PCB	2200	2700 - 6500	293	268	593	568	60	2.5	2	1318
PL11A12E05C	20	2835 SMD	PCB	2960	2700 - 6500	293	268	593	568	60	2.5	2	1318
PL11A14E04C	29	2835 SMD	PCB	3950	2700 - 6500	293	268	1193	1168	60	4.1	2	680
PL11A14E05C	42	2835 SMD	PCB	4475	2700 - 6500	293	268	1193	1168	60	4.1	2	680
PL11A22E04C	36	2835 SMD	PCB	3950	2700 - 6500	593	568	593	568	60	3.0	2	700
PL11A22E05C	42	2835 SMD	PCB	4475	2700 - 6500	593	568	593	568	60	3.0	2	700
PL11A22E06C	56	2835 SMD	PCB	5640	2700 - 6500	593	568	593	568	60	3.0	2	700
PL11A24E04C	72	2835 SMD	PCB	6885	2700 - 6500	593	568	1193	1168	60	6.0	2	360
PL11A24E05C	84	2835 SMD	PCB	7800	2700 - 6500	593	568	1193	1168	60	6.0	2	360
PL11A24E06C	112	2835 SMD	PCB	9835	2700 - 6500	593	568	1193	1168	60	6.0	2	360

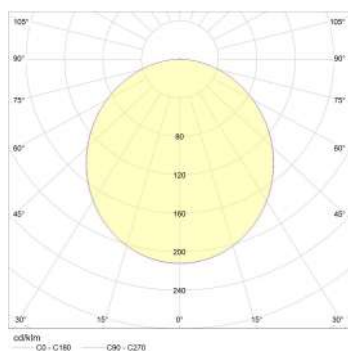
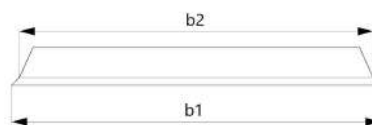
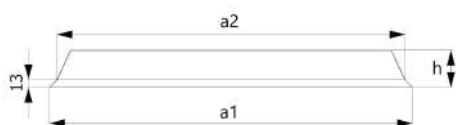

V / Hz | 220 - 240 / 50 - 60

Options	Options
Dimmable electronic ballast or convertor. Emergency kit	Ballast électronique dimmable ou converteur. Kit d'urgence.
NOTE	NOTE
Given lumen values are net delivered luminaire output lumens.	Les valeurs de lumens données sont les lumens de sortie nets du luminaire.
Given power values are total consumed AC power of the luminaire.	Les valeurs de puissance données sont la puissance AC totale consommée du luminaire.



RECESSED BACK LIGHT GYPSUM CEILING

LED

Lighting Fixtures With Frosted Diffuser

Luminaire Avec Diffuseur Givré

APPLICATION AREAS

Offices
Meeting rooms
Stores
Hospitals
Schools
Corridors

DOMAINES D'UTILISATION

Bureaux
Salles de Réunion
Magasins
Hopitaux
Ecoles
Couloirs

BODY

Electrostatic powder coated sheetmetal.

DIFFUSER

UV stabilized frosted diffuser.

CONVERTER

Long life, low power loss converter with constant current.
Compatible with ENEC standards.

LED

LED modules with 60.000 hours lifetime LUMILEDS /
SAMSUNG / NICHIA / SEOUL brand LEDs.

CORPS

Feuille de métal peinte électrostatiquement.

DIFFUSEUR

Diffuseur givré. Anti UV.

CONVERTEUR

Convertisseur, conforme aux normes ENEC. Longue vie. Perte de puissance faible avec courant constant .

LED

Modules LED – Durée de vie 60.000 heures avec LED de marque LUMILEDS / SAMSUNG / NICHIA / SEOUL.

Ceiling Mounting System
Système de Montage au Plafond

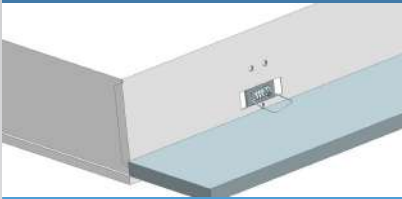

LED Type / Type LED

Color Rendering Index / Indice de Rendu des Couleurs: (CRI): Ra>80

Code	Power Puissance (W)	LED Type Type De LED	LED Module Module LED	Lum. Flux Flux Lum. (lm)	Color Temperature Température De Couleur (K)	Dimensions (mm)					Weight Poids (kg)	Packing Quantity Colisage	Pcs./20" Container Pcs./20" Conteneur
						a1	a2	b1	b2	h			
PL11AY11E06C	14	2835 SMD	PCB	1530	2700 - 6500	295	275	295	275	65	1.5	2	2596
PL11AY12E04C	14	2835 SMD	PCB	2250	2700 - 6500	295	275	595	575	65	2.5	2	1318
PL11AY12E05C	20	2835 SMD	PCB	3010	2700 - 6500	295	275	595	575	65	2.5	2	1318
PL11AY14E04C	29	2835 SMD	PCB	4055	2700 - 6500	295	275	1195	1175	65	4.1	2	680
PL11AY14E05C	42	2835 SMD	PCB	4590	2700 - 6500	295	275	1195	1175	65	4.1	2	680
PL11AY22E04C	36	2835 SMD	PCB	4055	2700 - 6500	595	575	595	575	65	3.0	2	700
PL11AY22E05C	42	2835 SMD	PCB	4590	2700 - 6500	595	575	595	575	65	3.0	2	700
PL11AY22E06C	56	2835 SMD	PCB	5790	2700 - 6500	595	575	595	575	65	3.0	2	700
PL11AY24E04C	72	2835 SMD	PCB	7065	2700 - 6500	595	575	1195	1175	65	6.0	2	360
PL11AY24E05C	84	2835 SMD	PCB	8005	2700 - 6500	595	575	1195	1175	65	6.0	2	360
PL11AY24E06C	112	2835 SMD	PCB	10095	2700 - 6500	595	575	1195	1175	65	6.0	2	360

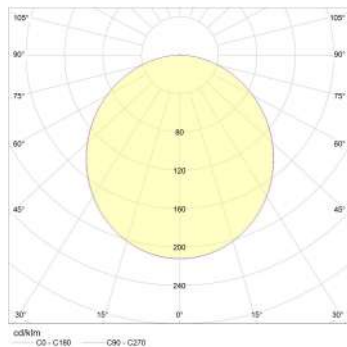
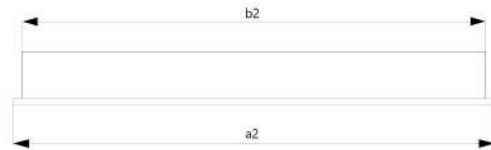
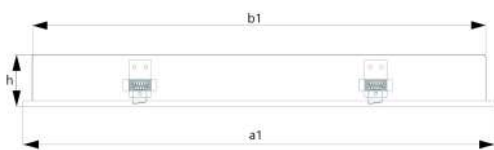

V / Hz 220 - 240 / 50 - 60

Options	Options
Dimmable electronic ballast or convertor.	Ballast électronique dimmable ou converteur.
Emergency kit	Kit d'urgence.
NOTE	NOTE
Given lumen values are net delivered luminaire output lumens.	Les valeurs de lumens données sont les lumens de sortie nets du luminaire.
Given power values are total consumed AC power of the luminaire.	Les valeurs de puissance données sont la puissance AC totale consommée du luminaire.



RECESSED INDIRECT

LED

Indirect Lighting Fixtures With Frosted Diffuser

Indirect Luminaires Avec Diffuseur Givré

APPLICATION AREAS

Offices
Meeting rooms
Stores
Hospitals
Schools
Corridors

DOMAINES D'UTILISATION

Bureaux
Salles de Réunion
Magasins
Hopitaux
Ecoles
Couloirs

BODY

Electrostatic powder coated sheetmetal.

DIFFUSER

UV stabilized microprismatic diffuser.

CONVERTER

Long life, low power loss converter with constant current.
Compatible with ENEC standards.

LED

LED modules with 60.000 hours lifetime LUMILEDS / SAMSUNG / NICHIA brand LEDs.

CORPS

Feuille de métal peinte électrostatiquement.

DIFFUSEUR

Diffuseur microprismatique stabilisé aux UV.

CONVERTEUR

Convertisseur, conforme aux normes ENEC. Longue vie. Perte de puissance faible avec courant constant .

LED

Modules LED – Durée de vie 60.000 heures avec LED de marque LUMILEDS / SAMSUNG / NICHIA.



LED Type / Type LED

Color Rendering Index / Indice de Rendu des Couleurs: (CRI): Ra>80

Code	Power Puissance (W)	LED Type Type De LED	LED Module Module LED	Lum. Flux Flux Lum. (lm)	Color Temperature Température De Couleur (K)	Dimensions (mm)			Weight Poids (kg)	Packing Quantity Colisage	Pcs./20" Container Pcs./20" Conteneur
						a	b	h			
PL11EA22L15C	26	2835 SMD	PCB	2810	2700 - 6500	594	594	80	3.7	2	690
PL11EA22L25C	41	2835 SMD	PCB	4210	2700 - 6500	594	594	80	3.8	2	690

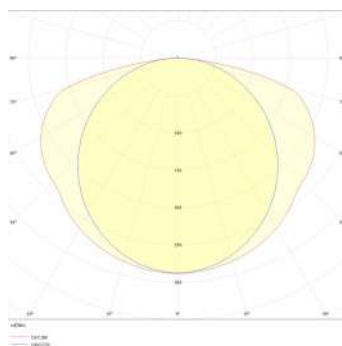
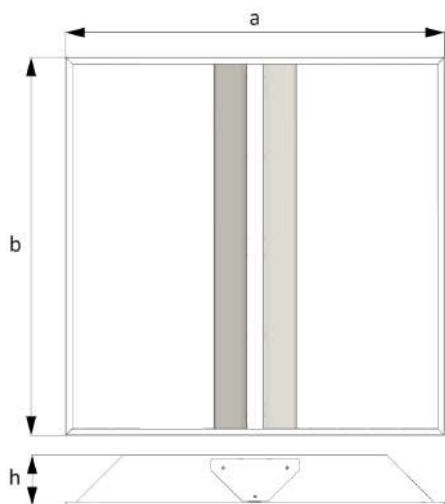

V / Hz | 220 - 240 / 50 - 60

Options	Options
Dimmable electronic ballast or convertor.	Ballast électronique dimmable ou converteur.
Emergency kit	Kit d'urgence.

NOTE	NOTE
Given lumen values are net delivered luminaire output lumens.	Les valeurs de lumens données sont les lumens de sortie nets du luminaire.
Given power values are total consumed AC power of the luminaire.	Les valeurs de puissance données sont la puissance AC totale consommée du luminaire.



 **pamir**[®]
aydınlatma



CLIP - IN



CLIP-IN BACK LIGHT

LED

Lighting Fixtures With Frosted Diffuser

Luminaires Avec Diffuseur Givré

APPLICATION AREAS

Offices
Meeting rooms
Stores
Hospitals
Schools
Corridors

DOMAINES D'UTILISATION

Bureaux
Salles de Réunion
Magasins
Hopitaux
Ecoles
Couloirs

BODY

Electrostatic powder coated sheetmetal.

DIFFUSER

UV stabilized frosted diffuser.

CONVERTER

Long life, low power loss converter with constant current.
Compatible with ENEC standards.

LED

LED modules with 60.000 hours lifetime LUMILEDS / SAMSUNG / NICHIA / SEOUL brand LEDs.

CORPS

Feuille de métal peinte électrostatiquement.

DIFFUSEUR

Diffuseur givré. Anti UV.

CONVERTEUR

Convertisseur, conforme aux normes ENEC. Longue vie. Perte de puissance faible avec courant constant .

LED

Modules LED – Durée de vie 60.000 heures avec LED de marque LUMILEDS / SAMSUNG / NICHIA / SEOUL.



LED Type / Type LED

Color Rendering Index / Indice de Rendu des Couleurs: (CRI): Ra>80

Code	Power Puissance (W)	LED Type Type De LED	LED Module Module LED	Lum. Flux Flux Lum. (lm)	Color Temperature Température De Couleur (K)	Dimensions (mm)					Weight Poids (kg)	Packing Quantity Colisage	Pcs./20" Container Pcs./20" Conteneur
						a1	a2	b1	b2	h			
PL11C11E06C	14	2835 SMD	PCB	1530	2700 - 6500	300	272	300	272	65	1.5	2	1318
PL11C12E04C	14	2835 SMD	PCB	2250	2700 - 6500	300	272	600	572	65	2.5	2	1318
PL11C12E05C	20	2835 SMD	PCB	3010	2700 - 6500	300	272	600	572	65	2.5	2	1318
PL11C14E04C	29	2835 SMD	PCB	4055	2700 - 6500	300	272	1200	1172	65	4.1	2	680
PL11C14E05C	42	2835 SMD	PCB	4590	2700 - 6500	300	272	1200	1172	65	4.1	2	680
PL11C22E04C	36	2835 SMD	PCB	4055	2700 - 6500	600	572	600	572	65	3.0	2	700
PL11C22E05C	42	2835 SMD	PCB	4590	2700 - 6500	600	572	600	572	65	3.0	2	700
PL11C22E06C	56	2835 SMD	PCB	5790	2700 - 6500	600	572	600	572	65	3.0	2	700
PL11C24E04C	72	2835 SMD	PCB	7065	2700 - 6500	600	572	1200	1172	65	6.0	2	360
PL11C24E05C	84	2835 SMD	PCB	8005	2700 - 6500	600	572	1200	1172	65	6.0	2	360
PL11C24E06C	112	2835 SMD	PCB	10095	2700 - 6500	600	572	1200	1172	65	6.0	2	360

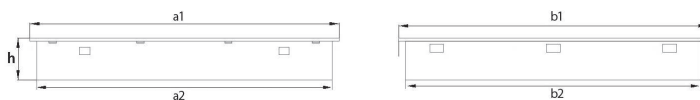

V / Hz 220 - 240 / 50 - 60

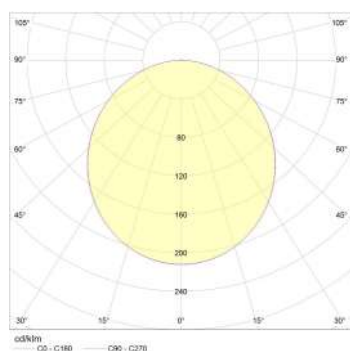

Options	Options
Dimmable electronic ballast or convertor. Emergency kit	Ballast électronique dimmable ou converteur. Kit d'urgence.
NOTE Given lumen values are net delivered luminaire output lumens. Given power values are total consumed AC power of the luminaire.	NOTE Les valeurs de lumens données sont les lumens de sortie nets du luminaire. Les valeurs de puissance données sont la puissance AC totale consommée du luminaire.





TRIM LINE

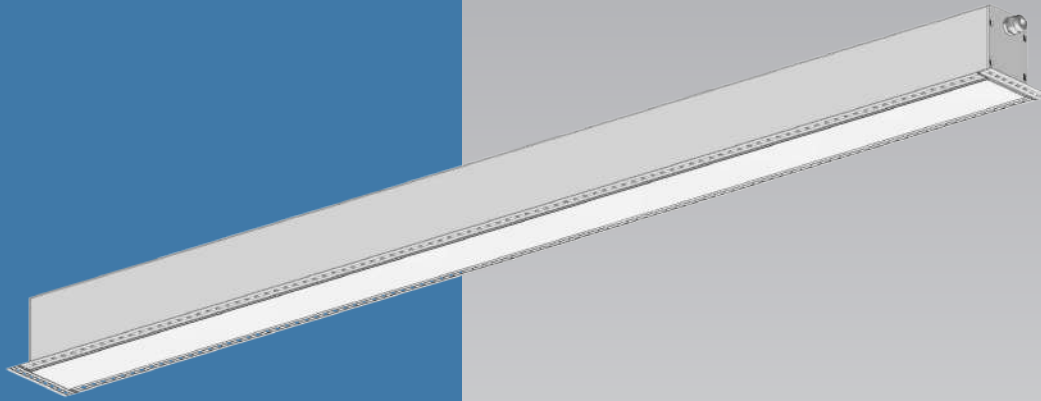

TRIM LINE

LED

Recessed Lighting Fixtures With Diffuser

Luminaire Encastrés Avec Diffuseur

APPLICATION AREAS

Shopping Malls
Supermarkets
Offices
Meeting rooms
Stores
Hospitals
Schools

DOMAINES D'UTILISATION

Centres Commerciaux
Supermarchés
Bureaux
Salles de Réunions
Magasins
Hopitaux
Ecoles

BODY

White colored aluminium.

DIFFUSER

UV stabilized extruded PC diffuser.

CONVERTER

Long life, low power loss converter with constant current.
Compatible with ENEC standards.

LED

LED modules with 60.000 hours lifetime LUMILEDS / SAMSUNG / NICHIA brand LEDs.

CORPS

Corps en aluminium de couleur blanc. Design Elegant.

DIFFUSEUR

Diffuseur en PC extrudé stabilisé aux UV.

CONVERTEUR

Convertisseur, conforme aux normes ENEC. Longue vie. Perte de puissance faible avec courant constant.

LED

Modules LED – Durée de vie 60.000 heures avec LED de marque LUMILEDS / SAMSUNG / NICHIA.

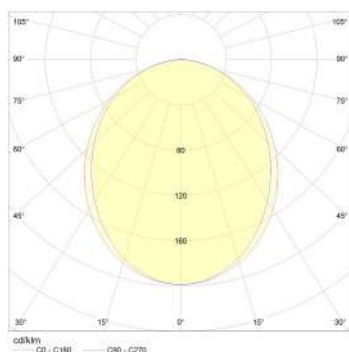

V / Hz 220 - 240 / 50 - 60

Options	Options
Dimmable electronic ballast or convertor.	Ballast électronique dimmable ou converteur.
Emergency kit	Kit d'urgence.

NOTE	NOTE
Given lumen values are net delivered luminaire output lumens.	Les valeurs de lumens données sont les lumens de sortie nets du luminaire.
Given power values are total consumed AC power of the luminaire.	Les valeurs de puissance données sont la puissance AC totale consommée du luminaire.

Ceiling Mounting System
Système de Montage au Plafond

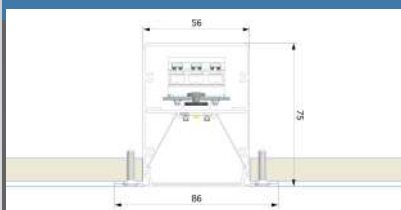

LED Type / Type LED

Color Rendering Index / Indice de Rendu des Couleurs: (CRI): Ra>80

Code	Power Puissance (W)	LED Type Type De LED	LED Module Module LED	Lum. Flux Flux Lum. (lm)	Color Temperature Température De Couleur (K)	Dimensions (mm)			Weight Poids (kg)	Packing Quantity Colisage	Pcs./20" Container Pcs./20" Conteneur
						a	l	h			
PL13A12L15C	14	2835 SMD	PCB	990	2700 - 6500	57	570	75	1.2	2	2908
PL13A12L25C	21	2835 SMD	PCB	1490	2700 - 6500	57	570	75	1.2	2	2908
PL13A13L15C	21	2835 SMD	PCB	1485	2700 - 6500	57	850	75	1.7	2	2908
PL13A13L25C	30	2835 SMD	PCB	2230	2700 - 6500	57	850	75	1.8	2	2908
PL13A14L15C	26	2835 SMD	PCB	1980	2700 - 6500	57	1130	75	2.1	2	2268
PL13A14L25C	41	2835 SMD	PCB	2975	2700 - 6500	57	1130	75	2.2	2	2268
PL13A15L15C	33	2835 SMD	PCB	2470	2700 - 6500	57	1412	75	2.5	2	1836
PL13A15L15CSB	33	2835 SMD	PCB	2470	2700 - 6500	57	1408	75	2.5	2	1836
PL13A15L15CSO	33	2835 SMD	PCB	2470	2700 - 6500	57	1404	75	2.5	2	1836
PL13A15L25C	51	2835 SMD	PCB	3720	2700 - 6500	57	1412	75	2.6	2	1836
PL13A15L25CSB	51	2835 SMD	PCB	3720	2700 - 6500	57	1408	75	2.6	2	1836
PL13A15L25CSO	51	2835 SMD	PCB	3720	2700 - 6500	57	1404	75	2.6	2	1836
PL13A16L15C	39	2835 SMD	PCB	2965	2700 - 6500	57	1693	75	2.9	2	1576
PL13A16L15CSB	39	2835 SMD	PCB	2965	2700 - 6500	57	1689	75	2.9	2	1576
PL13A16L15CSO	39	2835 SMD	PCB	2965	2700 - 6500	57	1685	75	2.9	2	1576
PL13A16L25C	61	2835 SMD	PCB	4465	2700 - 6500	57	1693	75	3.0	2	1576
PL13A16L25CSB	61	2835 SMD	PCB	4465	2700 - 6500	57	1689	75	3.0	2	1576
PL13A16L25CSO	61	2835 SMD	PCB	4465	2700 - 6500	57	1685	75	3.0	2	1576
PL13A17L15C	47	2835 SMD	PCB	3460	2700 - 6500	57	1973	75	3.3	2	1248
PL13A17L15CSB	47	2835 SMD	PCB	3460	2700 - 6500	57	1969	75	3.3	2	1248
PL13A17L15CSO	47	2835 SMD	PCB	3460	2700 - 6500	57	1965	75	3.3	2	1248
PL13A17L25C	70	2835 SMD	PCB	5205	2700 - 6500	57	1973	75	3.3	2	1248
PL13A17L25CSB	70	2835 SMD	PCB	5205	2700 - 6500	57	1969	75	3.3	2	1248
PL13A17L25CSO	70	2835 SMD	PCB	5205	2700 - 6500	57	1965	75	3.3	2	1248
PL13A18L15C	53	2835 SMD	PCB	3955	2700 - 6500	57	2254	75	3.7	2	1248
PL13A18L15CSB	53	2835 SMD	PCB	3955	2700 - 6500	57	2250	75	3.7	2	1248
PL13A18L15CSO	53	2835 SMD	PCB	3955	2700 - 6500	57	2246	75	3.7	2	1248
PL13A19L15C	60	2835 SMD	PCB	4450	2700 - 6500	57	2534	75	4.1	2	1004
PL13A19L15CSB	60	2835 SMD	PCB	4450	2700 - 6500	57	2530	75	4.1	2	1004
PL13A19L15CSO	60	2835 SMD	PCB	4450	2700 - 6500	57	2526	75	4.1	2	1004
PL13A10L15C	66	2835 SMD	PCB	4940	2700 - 6500	57	2815	75	4.5	2	1004
PL13A10L15CSB	66	2835 SMD	PCB	4940	2700 - 6500	57	2811	75	4.5	2	1004
PL13A10L15CSO	66	2835 SMD	PCB	4940	2700 - 6500	57	2807	75	4.5	2	1004

Visible frame width / Largeur de cadre visible: 86mm

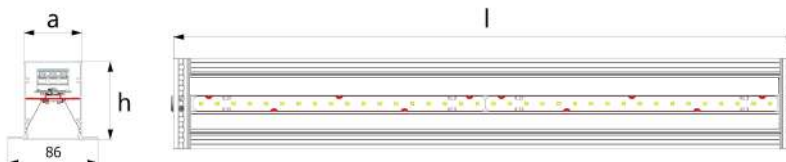



 **pamir**[®]
aydinlatma





ASYMMETRIC





ASYMMETRIC SURFACE

LED

Surface Mounted Asymmetric Lighting Fixtures With Diffuser

Asymétrique Luminaires Apparents Avec Diffuseur Givré

BODY

White or silver color options aluminum.

DIFFUSER

UV stabilized frosted diffuser.

CONVERTER

Long life, low power loss converter with constant current.
Compatible with ENEC standards.

LED

LED modules with 60.000 hours lifetime LUMILEDS /
SAMSUNG / NICHIA brand LEDs.

APPLICATION AREAS

Shopping Malls
Supermarkets
Offices
Meeting rooms
Stores
Hospitals
Schools
Corridors

DOMAINES D'UTILISATION

Centres Commerciaux
Supermarchés
Bureaux
Salles de Réunions
Magasins
Hopitaux
Ecoles
Couloirs

CORPS

Corps en aluminium de couleurs argent et blanc disponibles. Design Elegant.

DIFFUSEUR

Diffuseur givré. Anti UV.

CONVERTEUR

Convertisseur, conforme aux normes ENEC. Longue vie. Perte de puissance faible avec courant constant .

LED

Modules LED – Durée de vie 60.000 heures avec LED de marque LUMILEDS / SAMSUNG / NICHIA.

Color Options
Options de Couleur



LED Type / Type LED

Color Rendering Index / Indice de Rendu des Couleurs: (CRI): Ra>80

Code	Power Puissance (W)	LED Type Type De LED	LED Module Module LED	Lum. Flux Flux Lum. (lm)	Color Temperature Température De Couleur (K)	Dimensions (mm)			Weight Poids (kg)	Packing Quantity Colisage	Pcs./20" Container Pcs./20" Conteneur
						a	l	h			
PL15U12L15C	14	2835 SMD	PCB	950	2700 - 6500	63	573	93	1.7	3	2118
PL15U12L25C	21	2835 SMD	PCB	1430	2700 - 6500	63	573	93	1.8	3	2118
PL15U13L15C	21	2835 SMD	PCB	1425	2700 - 6500	63	854	93	2.1	3	2118
PL15U13L25C	30	2835 SMD	PCB	2145	2700 - 6500	63	854	93	2.2	3	2118
PL15U14L15C	26	2835 SMD	PCB	1900	2700 - 6500	63	1134	93	2.5	3	1701
PL15U14L25C	41	2835 SMD	PCB	2860	2700 - 6500	63	1134	93	2.6	3	1701
PL15U15L15C	33	2835 SMD	PCB	2375	2700 - 6500	63	1415	93	2.9	3	1377
PL15U15L25C	51	2835 SMD	PCB	3575	2700 - 6500	63	1415	93	3.0	3	1377
PL15U16L15C	39	2835 SMD	PCB	2850	2700 - 6500	63	1695	93	3.3	3	1182
PL15U16L25C	61	2835 SMD	PCB	4290	2700 - 6500	63	1695	93	3.5	3	1182
PL15U17L15C	47	2835 SMD	PCB	3325	2700 - 6500	63	1976	93	3.7	3	936
PL15U17L25C	70	2835 SMD	PCB	5005	2700 - 6500	63	1976	93	3.9	3	936
PL15U18L15C	53	2835 SMD	PCB	3800	2700 - 6500	63	2256	93	4.1	3	936
PL15U19L15C	60	2835 SMD	PCB	4275	2700 - 6500	63	2537	93	4.5	3	753
PL15U10L15C	66	2835 SMD	PCB	4750	2700 - 6500	63	2817	93	4.9	3	753

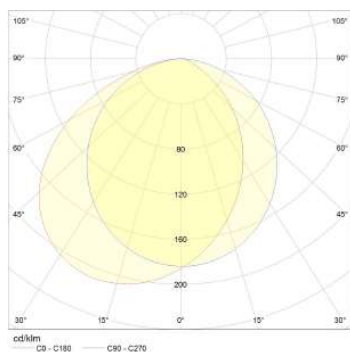
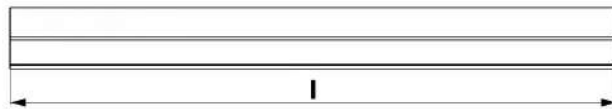
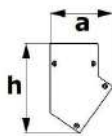

V / Hz 220 - 240 / 50 - 60

Options	Options
Dimmable electronic ballast or converter.	Ballast électronique dimmable ou converteur.
Emergency kit	Kit d'urgence.
NOTE	NOTE
Given lumen values are net delivered luminaire output lumens.	Les valeurs de lumens données sont les lumens de sortie nets du luminaire.
Given power values are total consumed AC power of the luminaire.	Les valeurs de puissance données sont la puissance AC totale consommée du luminaire.



ASYMMETRIC RECESSED

LED

Recessed Asymmetric Lighting Fixtures With Diffuser

Asymétrique Luminaires Encastrés Diffuseur Givré

APPLICATION AREAS

Shopping Malls
Supermarkets
Offices
Meeting rooms
Stores
Hospitals
Schools
Corridors

DOMAINES D'UTILISATION

Centres Commerciaux
Supermarchés
Bureaux
Salles de Réunions
Magasins
Hopitaux
Ecoles
Couloirs

BODY

White or silver color options aluminum.

DIFFUSER

UV stabilized extruded PC diffuser.

CONVERTER

Long life, low power loss converter with constant current.
Compatible with ENEC standards.

LED

LED modules with 60.000 hours lifetime LUMILEDS /
SAMSUNG / NICHIA brand LEDs.

CORPS

Corps en aluminium de couleurs argent et blanc disponibles. Design Elegant.

DIFFUSEUR

Diffuseur en PC extrudé stabilisé aux UV.

CONVERTEUR

Convertisseur, conforme aux normes ENEC. Longue vie. Perte de puissance faible avec courant constant .

LED

Modules LED – Durée de vie 60.000 heures avec LED de marque LUMILEDS / SAMSUNG / NICHIA.

Color Options
Options de Couleur



LED Type / Type LED

Color Rendering Index / Indice de Rendu des Couleurs: (CRI): Ra>80

Code	Power Puissance (W)	LED Type Type De LED	LED Module Module LED	Lum. Flux Flux Lum. (lm)	Color Temperature Température De Couleur (K)	Dimensions (mm)			Weight Poids (kg)	Packing Quantity Colisage	Pcs./20" Container Pcs./20" Conteneur
						a	l	h			
PL15A13L15C	21	2835 SMD	PCB	2055	2700 - 6500	88	861	93	1.7	3	2181
PL15A13L25C	30	2835 SMD	PCB	3090	2700 - 6500	88	861	93	1.8	3	2181
PL15A14L15C	26	2835 SMD	PCB	2740	2700 - 6500	88	1141	93	2.1	3	1701
PL15A14L25C	41	2835 SMD	PCB	4120	2700 - 6500	88	1141	93	2.2	3	1701
PL15A15L15C	33	2835 SMD	PCB	3420	2700 - 6500	88	1422	93	2.5	3	1377
PL15A15L25C	51	2835 SMD	PCB	5150	2700 - 6500	88	1422	93	2.6	3	1377
PL15A16L15C	39	2835 SMD	PCB	4105	2700 - 6500	88	1710	93	2.9	3	1182
PL15A16L25C	61	2835 SMD	PCB	6180	2700 - 6500	88	1710	93	3.0	3	1182
PL15A17L15C	47	2835 SMD	PCB	4790	2700 - 6500	88	1999	93	3.3	3	936
PL15A17L25C	70	2835 SMD	PCB	7210	2700 - 6500	88	1999	93	3.5	3	936
PL15A18L15C	53	2835 SMD	PCB	5475	2700 - 6500	88	2280	93	3.7	3	936
PL15A19L15C	60	2835 SMD	PCB	6160	2700 - 6500	88	2560	93	4.1	3	753
PL15A10L15C	66	2835 SMD	PCB	6840	2700 - 6500	88	2837	93	4.5	3	753

Visible frame width / Largeur de cadre visible: 104mm

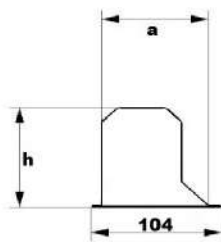
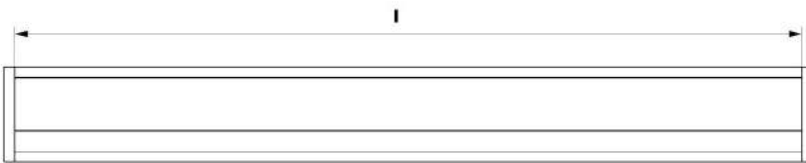

V / Hz 220 - 240 / 50 - 60

Options	Options
Dimmable electronic ballast or convertor. Emergency kit	Ballast électronique dimmable ou converteur. Kit d'urgence.
NOTE	NOTE
Given lumen values are net delivered luminaire output lumens.	Les valeurs de lumens données sont les lumens de sortie nets du luminaire.
Given power values are total consumed AC power of the luminaire.	Les valeurs de puissance données sont la puissance AC totale consommée du luminaire.

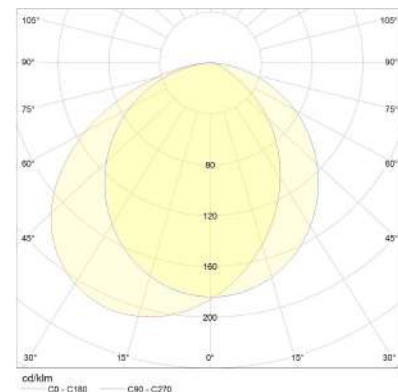



 **pamir**[®]
aydinlatma





V-LINE RECESSED



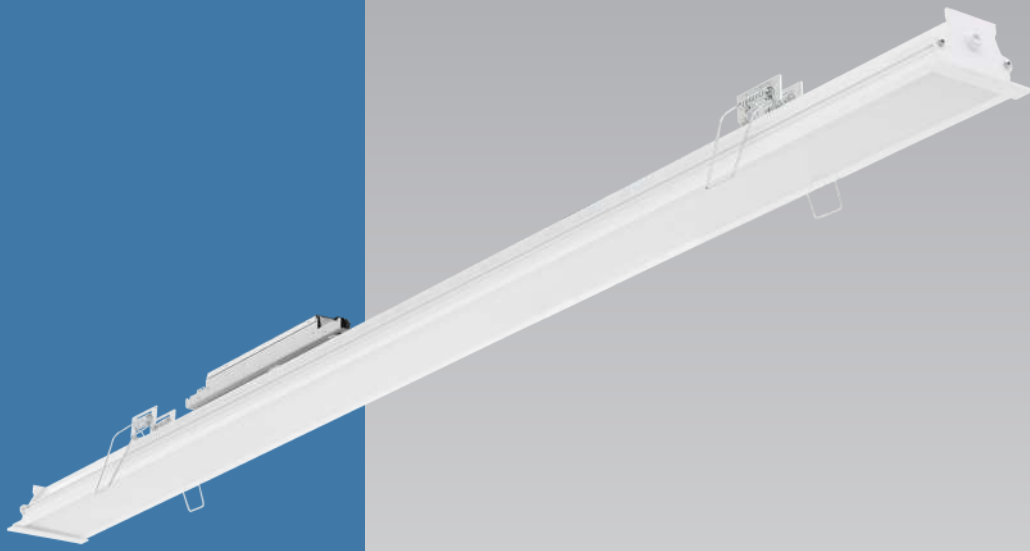

V-LINE RECESSED

LED

Recessed Lighting Fixtures With Diffuser

Luminaire Encastre Avec Diffuseur

APPLICATION AREAS

Shopping Malls
Supermarkets
Offices
Meeting rooms
Stores
Hospitals
Schools

DOMAINES D'UTILISATION

Centres Commerciaux
Supermarchés
Bureaux
Salles de Réunions
Magasins
Hopitaux
Ecoles

BODY

Anodized aluminum with satin finishing. Black and white color options with elegant design.

DIFFUSER

UV stabilized extruded PC diffuser.

CONVERTER

Long life, low power loss converter with constant current. Compatible with ENEC standards.

LED

LED modules with 60.000 hours lifetime LUMILEDS / SAMSUNG / NICHIA brand LEDs.

CORPS

Corps en aluminium anodisé, satiné. Design élégant. Couleurs blanc, noir disponibles.

DIFFUSEUR

Diffuseur en PC extrudé stabilisé aux UV.

CONVERTEUR

Convertisseur, conforme aux normes ENEC. Longue vie. Perte de puissance faible avec courant constant.

LED

Modules LED – Durée de vie 60.000 heures avec LED de marque LUMILEDS / SAMSUNG / NICHIA.

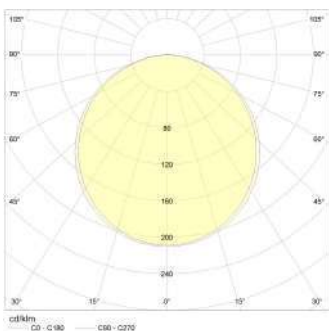

V / Hz 220 - 240 / 50 - 60

Options

Dimmable electronic ballast or converter.
Emergency kit

Options

Ballast électronique dimmable ou convertisseur.
Kit d'urgence.

NOTE

Given lumen values are net delivered luminaire output lumens.

Given power values are total consumed AC power of the luminaire.

NOTE

Les valeurs de lumens données sont les lumens de sortie nets du luminaire.

Les valeurs de puissance données sont la puissance AC totale consommée du luminaire.

Color Options
Options de Couleur



LED Type / Type LED

Color Rendering Index / Indice de Rendu des Couleurs: (CRI): Ra>80

Code	Power Puissance (W)	LED Type Type De LED	LED Module Module LED	Lum. Flux Flux Lum. (lm)	Température De Couleur (K)	Dimensions (mm)			Weight Poids (kg)	Packing Quantity Colisage	Pcs./20" Container Pcs./20" Conteneur
						a	l	h			
PL24A13L15C	21	2835 SMD	PCB	1655	2700 - 6500	57	861	72	1.7	4	2908
PL24A13L25C	30	2835 SMD	PCB	2490	2700 - 6500	57	861	72	1.8	4	2908
PL24A14L15C	26	2835 SMD	PCB	2205	2700 - 6500	57	1141	72	2.1	4	2268
PL24A14L25C	41	2835 SMD	PCB	3320	2700 - 6500	57	1141	72	2.2	4	2268
PL24A15L15C	33	2835 SMD	PCB	2755	2700 - 6500	57	1422	72	2.5	4	1826
PL24A15L15CSB	33	2835 SMD	PCB	2755	2700 - 6500	57	1420	72	2.5	4	1826
PL24A15L15CSO	33	2835 SMD	PCB	2755	2700 - 6500	57	1418	72	2.5	4	1826
PL24A15L25C	51	2835 SMD	PCB	4150	2700 - 6500	57	1422	72	2.6	4	1826
PL24A15L25CSB	51	2835 SMD	PCB	4150	2700 - 6500	57	1420	72	2.6	4	1826
PL24A15L25CSO	51	2835 SMD	PCB	4150	2700 - 6500	57	1418	72	2.6	4	1826
PL24A16L15C	39	2835 SMD	PCB	3305	2700 - 6500	57	1711	72	2.9	4	1576
PL24A16L15CSB	39	2835 SMD	PCB	3305	2700 - 6500	57	1709	72	2.9	4	1576
PL24A16L15CSO	39	2835 SMD	PCB	3305	2700 - 6500	57	1707	72	2.9	4	1576
PL24A16L25C	61	2835 SMD	PCB	4975	2700 - 6500	57	1711	72	3.0	4	1576
PL24A16L25CSB	61	2835 SMD	PCB	4975	2700 - 6500	57	1709	72	3.0	4	1576
PL24A16L25CSO	61	2835 SMD	PCB	4975	2700 - 6500	57	1707	72	3.0	4	1576
PL24A17L15C	47	2835 SMD	PCB	3855	2700 - 6500	57	1999	72	3.3	4	1250
PL24A17L15CSB	47	2835 SMD	PCB	3855	2700 - 6500	57	1997	72	3.3	4	1250
PL24A17L15CSO	47	2835 SMD	PCB	3855	2700 - 6500	57	1995	72	3.3	4	1250
PL24A17L25C	70	2835 SMD	PCB	5805	2700 - 6500	57	1999	72	3.5	4	1250
PL24A17L25CSB	70	2835 SMD	PCB	5805	2700 - 6500	57	1997	72	3.5	4	1250
PL24A17L25CSO	70	2835 SMD	PCB	5805	2700 - 6500	57	1995	72	3.5	4	1250
PL24A18L15C	53	2835 SMD	PCB	4410	2700 - 6500	57	2280	72	3.7	4	1250
PL24A18L15CSB	53	2835 SMD	PCB	4410	2700 - 6500	57	2278	72	3.7	4	1250
PL24A18L15CSO	53	2835 SMD	PCB	4410	2700 - 6500	57	2276	72	3.7	4	1250
PL24A19L15C	60	2835 SMD	PCB	4960	2700 - 6500	57	2560	72	4.1	4	1005
PL24A19L15CSB	60	2835 SMD	PCB	4960	2700 - 6500	57	2558	72	4.1	4	1005
PL24A19L15CSO	60	2835 SMD	PCB	4960	2700 - 6500	57	2556	72	4.1	4	1005
PL24A10L15C	66	2835 SMD	PCB	5510	2700 - 6500	57	2840	72	4.5	4	1005
PL24A10L15CSB	66	2835 SMD	PCB	5510	2700 - 6500	57	2838	72	4.5	4	1005
PL24A10L15CSO	66	2835 SMD	PCB	5510	2700 - 6500	57	2836	72	4.5	4	1005

Visible frame width / Largeur de cadre visible: 72mm

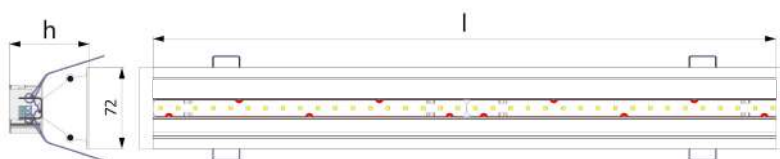





SLIM LINE



SLIM LINE

LED

Recessed Lighting Fixtures With Diffuser

Luminaire Encastrés Avec Diffuseur

APPLICATION AREAS

Shopping Malls
Supermarkets
Offices
Meeting rooms
Stores
Hospitals
Schools

DOMAINES D'UTILISATION

Centres Commerciaux
Supermarchés
Bureaux
Salles de Réunions
Magasins
Hopitaux
Ecoles

BODY

White or silver color options aluminum.

DIFFUSER

UV stabilized extruded PC diffuser.

CONVERTER

Long life, low power loss converter with constant current.
Compatible with ENEC standards.

LED

LED modules with 60.000 hours lifetime LUMILEDS / SAMSUNG / NICHIA brand LEDs.

CORPS

Corps en aluminium de couleurs argent et blanc disponibles. Design Elegant.

DIFFUSEUR

Diffuseur en PC extrudé stabilisé aux UV.

CONVERTEUR

Convertisseur, conforme aux normes ENEC. Longue vie. Perte de puissance faible avec courant constant .

LED

Modules LED – Durée de vie 60.000 heures avec LED de marque LUMILEDS / SAMSUNG / NICHIA.

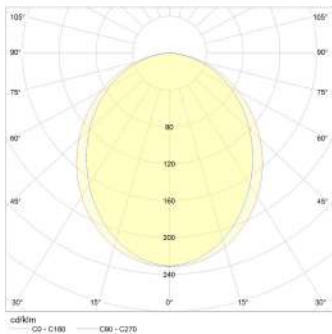

V / Hz 220 - 240 / 50 - 60

Options	Options
Dimmable electronic ballast or convertor.	Ballast électronique dimmable ou converteur.
Emergency kit	Kit d'urgence.

NOTE	NOTE
Given lumen values are net delivered luminaire output lumens.	Les valeurs de lumens données sont les lumens de sortie nets du luminaire.
Given power values are total consumed AC power of the luminaire.	Les valeurs de puissance données sont la puissance AC totale consommée du luminaire.

Color Options
Options de Couleur



LED Type / Type LED

Color Rendering Index / Indice de Rendu des Couleurs: (CRI): Ra>80

Code	Power Puissance (W)	LED Type Type De LED	LED Module Module LED	Lum. Flux Flux Lum. (lm)	Température De Couleur (K)	Dimensions (mm)			Weight Poids (kg)	Packing Quantity Colisage	Pcs./20" Container Pcs./20" Conteneur
						a	l	h			
PL14A13L15C	21	2835 SMD	PCB	1655	2700 - 6500	57	861	75	1.7	4	2908
PL14A13L25C	30	2835 SMD	PCB	2490	2700 - 6500	57	861	75	1.8	4	2908
PL14A14L15C	26	2835 SMD	PCB	2205	2700 - 6500	57	1141	75	2.1	4	2268
PL14A14L25C	41	2835 SMD	PCB	3320	2700 - 6500	57	1141	75	2.2	4	2268
PL14A15L15C	33	2835 SMD	PCB	2755	2700 - 6500	57	1422	75	2.5	4	1826
PL14A15L15CSB	33	2835 SMD	PCB	2755	2700 - 6500	57	1420	75	2.5	4	1826
PL14A15L15CSO	33	2835 SMD	PCB	2755	2700 - 6500	57	1418	75	2.5	4	1826
PL14A15L25C	51	2835 SMD	PCB	4150	2700 - 6500	57	1422	75	2.6	4	1826
PL14A15L25CSB	51	2835 SMD	PCB	4150	2700 - 6500	57	1420	75	2.6	4	1826
PL14A15L25CSO	51	2835 SMD	PCB	4150	2700 - 6500	57	1418	75	2.6	4	1826
PL14A16L15C	39	2835 SMD	PCB	3305	2700 - 6500	57	1711	75	2.9	4	1576
PL14A16L15CSB	39	2835 SMD	PCB	3305	2700 - 6500	57	1709	75	2.9	4	1576
PL14A16L15CSO	39	2835 SMD	PCB	3305	2700 - 6500	57	1707	75	2.9	4	1576
PL14A16L25C	61	2835 SMD	PCB	4975	2700 - 6500	57	1711	75	3.0	4	1576
PL14A16L25CSB	61	2835 SMD	PCB	4975	2700 - 6500	57	1709	75	3.0	4	1576
PL14A16L25CSO	61	2835 SMD	PCB	4975	2700 - 6500	57	1707	75	3.0	4	1576
PL14A17L15C	47	2835 SMD	PCB	3855	2700 - 6500	57	1999	75	3.3	4	1250
PL14A17L15CSB	47	2835 SMD	PCB	3855	2700 - 6500	57	1997	75	3.3	4	1250
PL14A17L15CSO	47	2835 SMD	PCB	3855	2700 - 6500	57	1995	75	3.3	4	1250
PL14A17L25C	70	2835 SMD	PCB	5805	2700 - 6500	57	1999	75	3.5	4	1250
PL14A17L25CSB	70	2835 SMD	PCB	5805	2700 - 6500	57	1997	75	3.5	4	1250
PL14A17L25CSO	70	2835 SMD	PCB	5805	2700 - 6500	57	1995	75	3.5	4	1250
PL14A18L15C	53	2835 SMD	PCB	4410	2700 - 6500	57	2280	75	3.7	4	1250
PL14A18L15CSB	53	2835 SMD	PCB	4410	2700 - 6500	57	2278	75	3.7	4	1250
PL14A18L15CSO	53	2835 SMD	PCB	4410	2700 - 6500	57	2276	75	3.7	4	1250
PL14A19L15C	60	2835 SMD	PCB	4960	2700 - 6500	57	2560	75	4.1	4	1005
PL14A19L15CSB	60	2835 SMD	PCB	4960	2700 - 6500	57	2558	75	4.1	4	1005
PL14A19L15CSO	60	2835 SMD	PCB	4960	2700 - 6500	57	2556	75	4.1	4	1005
PL14A10L15C	66	2835 SMD	PCB	5510	2700 - 6500	57	2840	75	4.5	4	1005
PL14A10L15CSB	66	2835 SMD	PCB	5510	2700 - 6500	57	2838	75	4.5	4	1005
PL14A10L15CSO	66	2835 SMD	PCB	5510	2700 - 6500	57	2836	75	4.5	4	1005

Visible frame width / Largeur de cadre visible: 72mm







PROLINE

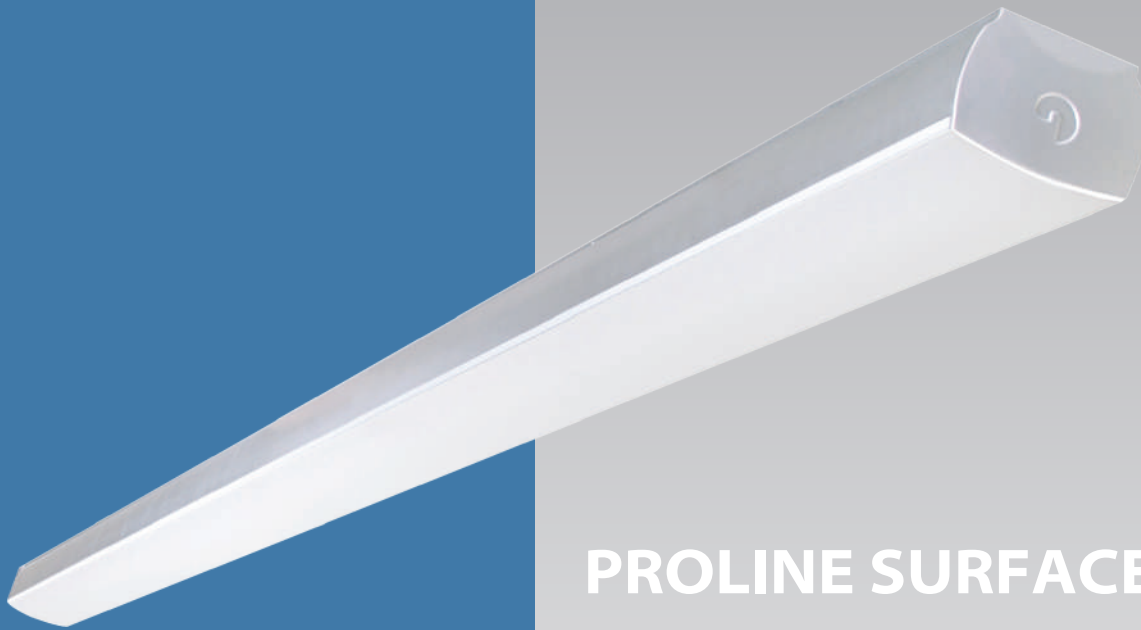

PROLINE SURFACE

LED

Surface Mounted Lighting Fixtures With Diffuser Luminaires Apparents Avec Diffuseur

APPLICATION AREAS

Shopping Malls
Supermarkets
Offices
Meeting rooms
Stores
Hospitals
Schools
Corridors

DOMAINES D'UTILISATION

Centres Commerciaux
Supermarchés
Bureaux
Salles de Réunions
Magasins
Hopitaux
Ecoles
Couloirs

BODY

Anodized aluminum with satin finishing, elegant design with silver color.

DIFFUSER

UV stabilized extruded PC diffuser.

CONVERTER

Long life, low power loss converter with constant current. Compatible with ENEC standards.

LED

LED modules with 60.000 hours lifetime LUMILEDS / SAMSUNG / NICHIA brand LEDs.

CORPS

Corps en aluminium anodisé, satiné. Design Elegant Couleur Argent.

DIFFUSEUR

Diffuseur en PC extrudé stabilisé aux UV.

CONVERTEUR

Convertisseur, conforme aux normes ENEC. Longue vie. Perte de puissance faible avec courant constant.

LED

Modules LED – Durée de vie 60.000 heures avec LED de marque LUMILEDS / SAMSUNG / NICHIA.

V / Hz 220 - 240 / 50 - 60

Options	Options
 <p>Suspension: Composed of 1mm steel wire rope and nickel-plated brass components. Suspension height is adjustable. Supplied with transparent electric cord and ceiling mounted electrical junction box with aesthetic design.</p>	<p>Fixation: Comprend un cable en acier de 1 mm et des composants en laiton nickelé. Livré avec un cordon électrique transparent, une boîte de jonction électrique au design esthétique, à fixer au plafond.</p>

Options	Options
Dimmable electronic ballast or convertor. Emergency kit	Ballast électronique dimmable ou converteur. Kit d'urgence.
NOTE	NOTE
Given lumen values are net delivered luminaire output lumens.	Les valeurs de lumens données sont les lumens de sortie nets du luminaire.
Given power values are total consumed AC power of the luminaire.	Les valeurs de puissance données sont la puissance AC totale consommée du luminaire.



LED Type / Type LED

Color Rendering Index / Indice de Rendu des Couleurs: (CRI): Ra>80

Code	Power Puissance (W)	LED Type Type De LED	LED Module Module LED	Lum. Flux Flux Lum. (lm)	Color Temperature Température De Couleur (K)	Dimensions (mm)			Weight Poids (kg)	Packing Quantity Colisage	Pcs./20" Container Pcs./20" Conteneur
						a	b	h			
PL2U13L15C	21	2835 SMD	PCB	2140	2700 - 6500	98	853	76	1.6	5	3635
PL2U13L25C	30	2835 SMD	PCB	3220	2700 - 6500	98	853	76	1.6	5	3635
PL2U14L15C	26	2835 SMD	PCB	2850	2700 - 6500	98	1133	76	2.2	5	2835
PL2U14L25C	41	2835 SMD	PCB	4290	2700 - 6500	98	1133	76	2.2	5	2835
PL2U15L15C	33	2835 SMD	PCB	3565	2700 - 6500	98	1414	76	2.7	5	2295
PL2U15L15CSB	33	2835 SMD	PCB	3565	2700 - 6500	98	1409	76	2.6	5	2295
PL2U15L25CSO	33	2835 SMD	PCB	3565	2700 - 6500	98	1404	76	2.5	5	2295
PL2U15L25C	51	2835 SMD	PCB	5365	2700 - 6500	98	1414	76	2.7	5	2295
PL2U15L25CSB	51	2835 SMD	PCB	5365	2700 - 6500	98	1409	76	2.6	5	2295
PL2U15L25CSO	51	2835 SMD	PCB	5365	2700 - 6500	98	1404	76	2.5	5	2295
PL2U16L15C	39	2835 SMD	PCB	4275	2700 - 6500	98	1695	76	3.3	5	1970
PL2U16L15CSB	39	2835 SMD	PCB	4275	2700 - 6500	98	1690	76	3.2	5	1970
PL2U16L15CSO	39	2835 SMD	PCB	4275	2700 - 6500	98	1685	76	3.1	5	1970
PL2U16L25C	61	2835 SMD	PCB	6435	2700 - 6500	98	1695	76	3.3	5	1970
PL2U16L25CSB	61	2835 SMD	PCB	6435	2700 - 6500	98	1690	76	3.2	5	1970
PL2U16L25CSO	61	2835 SMD	PCB	6435	2700 - 6500	98	1685	76	3.1	5	1970
PL2U17L15C	47	2835 SMD	PCB	4990	2700 - 6500	98	1976	76	3.8	5	1560
PL2U17L15CSB	47	2835 SMD	PCB	4990	2700 - 6500	98	1971	76	3.7	5	1560
PL2U17L15CSO	47	2835 SMD	PCB	4990	2700 - 6500	98	1966	76	3.6	5	1560
PL2U17L25C	70	2835 SMD	PCB	7510	2700 - 6500	98	1976	76	3.8	5	1560
PL2U17L25CSB	70	2835 SMD	PCB	7510	2700 - 6500	98	1971	76	3.7	5	1560
PL2U17L25CSO	70	2835 SMD	PCB	7510	2700 - 6500	98	1966	76	3.6	5	1560
PL2U18L15C	53	2835 SMD	PCB	5700	2700 - 6500	98	2256	76	4.3	5	1560
PL2U18L15CSB	53	2835 SMD	PCB	5700	2700 - 6500	98	2251	76	4.2	5	1560
PL2U18L15CSO	53	2835 SMD	PCB	5700	2700 - 6500	98	2246	76	4.1	5	1560
PL2U19L15C	60	2835 SMD	PCB	6415	2700 - 6500	98	2536	76	4.8	5	1255
PL2U19L15CSB	60	2835 SMD	PCB	6415	2700 - 6500	98	2531	76	4.7	5	1255
PL2U19L15CSO	60	2835 SMD	PCB	6415	2700 - 6500	98	2526	76	4.6	5	1255
PL2U10L15C	66	2835 SMD	PCB	7125	2700 - 6500	98	2816	76	5.3	5	1255
PL2U10L15CSB	66	2835 SMD	PCB	7125	2700 - 6500	98	2811	76	5.2	5	1255
PL2U10L15CSO	66	2835 SMD	PCB	7125	2700 - 6500	98	2806	76	5.1	5	1255

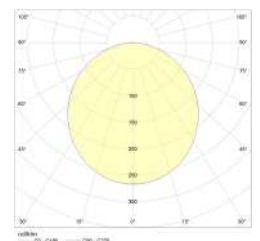
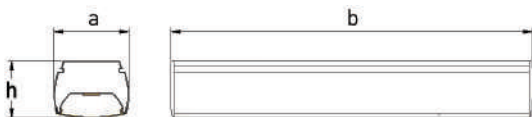

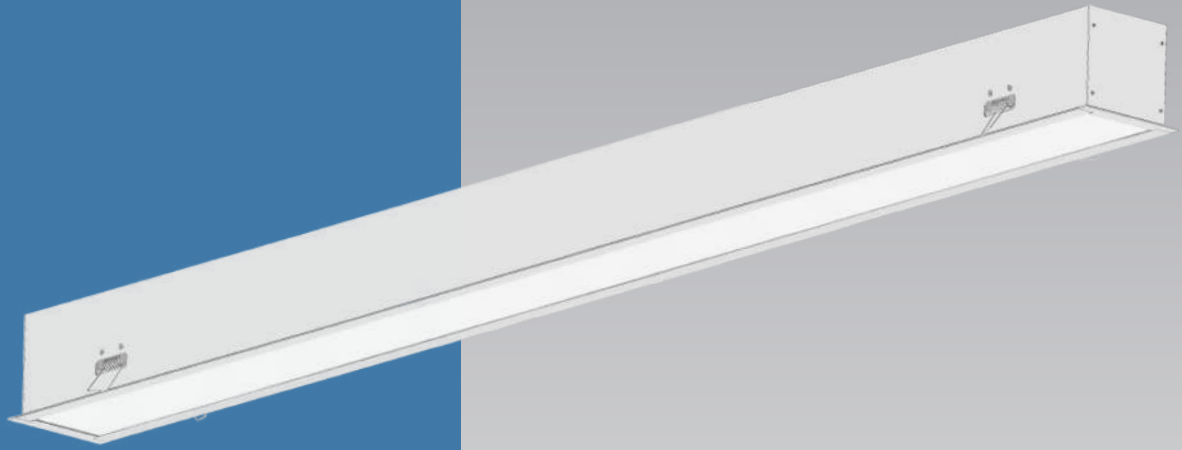

PROLINE RECESSED

LED

Recessed Lighting Fixtures With Diffuser

Luminaire Encastrés Avec Diffuseur

APPLICATION AREAS

Shopping Malls
Supermarkets
Offices
Meeting rooms
Stores
Hospitals
Schools
Corridors

DOMAINES D'UTILISATION

Centres Commerciaux
Supermarchés
Bureaux
Salles de Réunions
Magasins
Hopitaux
Ecoles
Couloirs

BODY

Anodized aluminum with satin finishing. Black and white color options with elegant design.

DIFFUSER

UV stabilized frosted diffuser.

CONVERTER

Long life, low power loss converter with constant current. Compatible with ENEC standards.

LED

LED modules with 60.000 hours lifetime LUMILEDS / SAMSUNG / NICHIA brand LEDs.

CORPS

Corps en aluminium anodisé, satiné. Design élégant. Couleurs blanc, noir disponibles.

DIFFUSEUR

Diffuseur givré. Anti UV.

CONVERTEUR

Convertisseur, conforme aux normes ENEC. Longue vie. Perte de puissance faible avec courant constant.

LED

Modules LED – Durée de vie 60.000 heures avec LED de marque LUMILEDS / SAMSUNG / NICHIA.

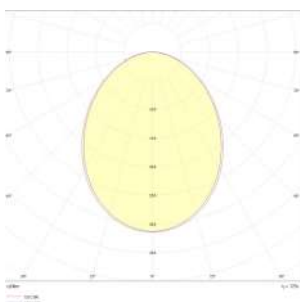

V / Hz 220 - 240 / 50 - 60

Options	Options
Dimmable electronic ballast or convertor.	Ballast électronique dimmable ou converteur.
Emergency kit	Kit d'urgence.

NOTE	NOTE
Given lumen values are net delivered luminaire output lumens.	Les valeurs de lumens données sont les lumens de sortie nets du luminaire.
Given power values are total consumed AC power of the luminaire.	Les valeurs de puissance données sont la puissance AC totale consommée du luminaire.

Ceiling Mounting System
Système de Montage au Plafond

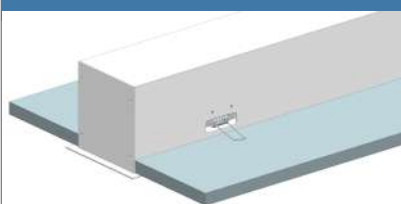

LED Type / Type LED

Color Rendering Index / Indice de Rendu des Couleurs: (CRI): Ra>80

Code	Power Puissance (W)	LED Type Type De LED	LED Module Module LED	Lum. Flux Flux Lum. (lm)	Color Temperature Température De Couleur (K)	Dimensions (mm)			Weight Poids (kg)	Packing Quantity Colisage	Pcs./20" Container Pcs./20" Conteneur
						a	b	h			
PL2A11L15C	8	2835 SMD	PCB	685	2700 - 6500	84	290	84	1.2	2	4230
PL2A11L25C	12	2835 SMD	PCB	1030	2700 - 6500	84	290	84	1.2	2	4230
PL2A12L15C	14	2835 SMD	PCB	1370	2700 - 6500	84	571	84	1.5	2	2268
PL2A12L25C	21	2835 SMD	PCB	2055	2700 - 6500	84	571	84	1.5	2	2268
PL2A13L15C	21	2835 SMD	PCB	2055	2700 - 6500	84	851	84	2.0	2	1412
PL2A13L25C	30	2835 SMD	PCB	3080	2700 - 6500	84	851	84	2.0	2	1412
PL2A14L15C	26	2835 SMD	PCB	2740	2700 - 6500	84	1132	84	2.6	2	1134
PL2A14L25C	41	2835 SMD	PCB	4105	2700 - 6500	84	1132	84	2.6	2	1134
PL2A15L15C	33	2835 SMD	PCB	3420	2700 - 6500	84	1412	84	3.3	2	980
PL2A15L15CSB	33	2835 SMD	PCB	3420	2700 - 6500	84	1410	84	3.3	2	980
PL2A15L15CSO	33	2835 SMD	PCB	3420	2700 - 6500	84	1408	84	3.3	2	980
PL2A15L25C	51	2835 SMD	PCB	5130	2700 - 6500	84	1412	84	3.3	2	980
PL2A15L25CSB	51	2835 SMD	PCB	5130	2700 - 6500	84	1410	84	3.3	2	980
PL2A15L25CSO	51	2835 SMD	PCB	5130	2700 - 6500	84	1408	84	3.3	2	980
PL2A16L15C	39	2835 SMD	PCB	4105	2700 - 6500	84	1692	84	3.9	2	870
PL2A16L15CSB	39	2835 SMD	PCB	4105	2700 - 6500	84	1690	84	3.9	2	870
PL2A16L15CSO	39	2835 SMD	PCB	4105	2700 - 6500	84	1688	84	3.9	2	870
PL2A16L25C	61	2835 SMD	PCB	6160	2700 - 6500	84	1692	84	3.9	2	870
PL2A16L25CSB	61	2835 SMD	PCB	6160	2700 - 6500	84	1690	84	3.9	2	870
PL2A16L25CSO	61	2835 SMD	PCB	6160	2700 - 6500	84	1688	84	3.9	2	870
PL2A17L15C	47	2835 SMD	PCB	4790	2700 - 6500	84	1973	84	4.5	2	740
PL2A17L15CSB	47	2835 SMD	PCB	4790	2700 - 6500	84	1971	84	4.5	2	740
PL2A17L15CSO	47	2835 SMD	PCB	4790	2700 - 6500	84	1969	84	4.5	2	740
PL2A17L25C	70	2835 SMD	PCB	7185	2700 - 6500	84	1973	84	4.5	2	740
PL2A17L25CSB	70	2835 SMD	PCB	7185	2700 - 6500	84	1971	84	4.5	2	740
PL2A17L25CSO	70	2835 SMD	PCB	7185	2700 - 6500	84	1969	84	4.5	2	740
PL2A18L15C	53	2835 SMD	PCB	5475	2700 - 6500	84	2254	84	5.1	2	650
PL2A18L15CSB	53	2835 SMD	PCB	5475	2700 - 6500	84	2252	84	5.1	2	650
PL2A18L15CSO	53	2835 SMD	PCB	5475	2700 - 6500	84	2250	84	5.1	2	650
PL2A19L15C	60	2835 SMD	PCB	6160	2700 - 6500	84	2534	84	5.5	2	576
PL2A19L15CSB	60	2835 SMD	PCB	6160	2700 - 6500	84	2532	84	5.5	2	576
PL2A19L15CSO	60	2835 SMD	PCB	6160	2700 - 6500	84	2530	84	5.5	2	576
PL2A10L15C	66	2835 SMD	PCB	6840	2700 - 6500	84	2815	84	5.9	2	520
PL2A10L15CSB	66	2835 SMD	PCB	6840	2700 - 6500	84	2813	84	5.9	2	520
PL2A10L15CSO	66	2835 SMD	PCB	6840	2700 - 6500	84	2811	84	5.9	2	520

Visible frame width / Largeur de cadre visible: 95mm

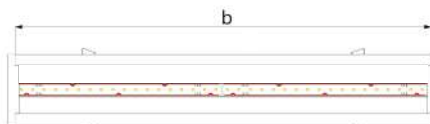
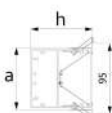



 **pamir**[®]
aydınlatma



WALLWASHER



WALLWASHER

LED

Wall Washer With Lens

Lèche-Mur Avec Lentille

APPLICATION AREAS

Tunnels
Warehouses
Factories
Sport Areas
Outdoor Lighting
Open-air Car Park

DOMAINES D'UTILISATION

Tunnels
Hangars de Stockage
Usines
Complexes Sportifs
Espaces Extérieurs
Parking en Plein Air

BODY

High-resistance body against harsh natural conditions with 20 micron electrical coating.

LENS

Lenses with wide variety of light distribution angle options and high light transparency. (15° / 30° / 60°)

CONVERTER

Converter compatible with ENEC standards.

LED

LED modules with 60.000 hours lifetime CREE / SAMSUNG / NICHIA brand LEDs.

CORPS

Corps à haute résistance contre les conditions naturelles difficiles avec revêtement électrique de 20 microns..

LENS

Lentilles avec une grande variété d'options d'angle de distribution de lumière, et transparence de grande. (15° / 30° / 60°)

CONVERTEUR

Convertisseur, conforme aux normes ENEC.

LED

Modules LED – Durée de vie 60.000 heures avec LED de marque CREE / SAMSUNG / NICHIA.



3000K / 4000K / 6500K

Color Rendering Index / Indice de Rendu des Couleurs: (CRI): Ra>70

Code	Power Puissance (W)	Led Type Type De Led	Lum. Flux Flux Lum. (lm)	Color Temperature Température de couleur(K)	Dimensions (mm) l h	Weight Poids (kg)	Packing Quantity Colisage	Pcs./20" Container Pcs./20" Conteneur
EALW11U	11	Power Led	900	3000 - 4000 - 6500	173 180	0,7	1	741
EALW20U	20	Power Led	1900	3000 - 4000 - 6500	329 180	1,1	1	417
EALW38U	38	Power Led	3600	3000 - 4000 - 6500	614 180	1,8	1	231
EALW54U	54	Power Led	4800	3000 - 4000 - 6500	914 180	2,8	1	157
EALW64U	64	Power Led	6250	3000 - 4000 - 6500	1064 180	3,0	1	136
EALW76U	76	Power Led	7000	3000 - 4000 - 6500	1214 180	3,5	1	119

Red-Blue-Green-Amber / Rouge-Bleu-Vert-Ambre

Color Rendering Index / Indice de Rendu des Couleurs: (CRI): Ra>70

Code	Power Puissance (W)	Led Type Type De Led	Color Temperature Température de couleur(K)	Dimensions (mm) l h	Weight Poids (kg)	Packing Quantity Colisage	Pcs./20" Container Pcs./20" Conteneur
EALWA9U	9	Power Led	Red-Blue-Green-Amber	173 180	0,7	1	741
EALWA16U	16	Power Led	Red-Blue-Green-Amber	329 180	1,1	1	417
EALWA30U	30	Power Led	Red-Blue-Green-Amber	614 180	1,8	1	231
EALWA46U	46	Power Led	Red-Blue-Green-Amber	914 180	2,8	1	157
EALWA52U	52	Power Led	Red-Blue-Green-Amber	1064 180	3,0	1	136
EALWA60U	60	Power Led	Red-Blue-Green-Amber	1214 180	3,5	1	119

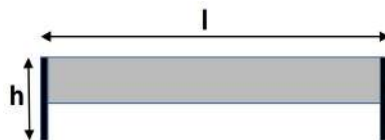

15° Lens

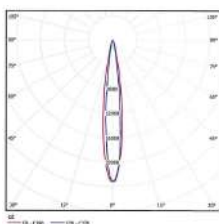

30° Lens

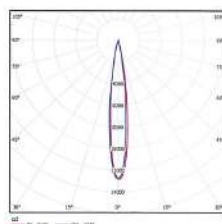

60° Lens

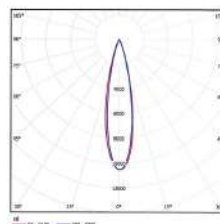

V / Hz 220 - 240 / 50 - 60

Options	Options
Dimmable electronic ballast or convertor.	Ballast électronique dimmable ou converteur.
Emergency kit	Kit d'urgence.

NOTE	NOTE
Given lumen values are net delivered luminaire output lumens.	Les valeurs de lumens données sont les lumens de sortie nets du luminaire.
Given power values are total consumed AC power of the luminaire.	Les valeurs de puissance données sont la puissance AC totale consommée du luminaire.



 **pamir**[®]
aydinlatma

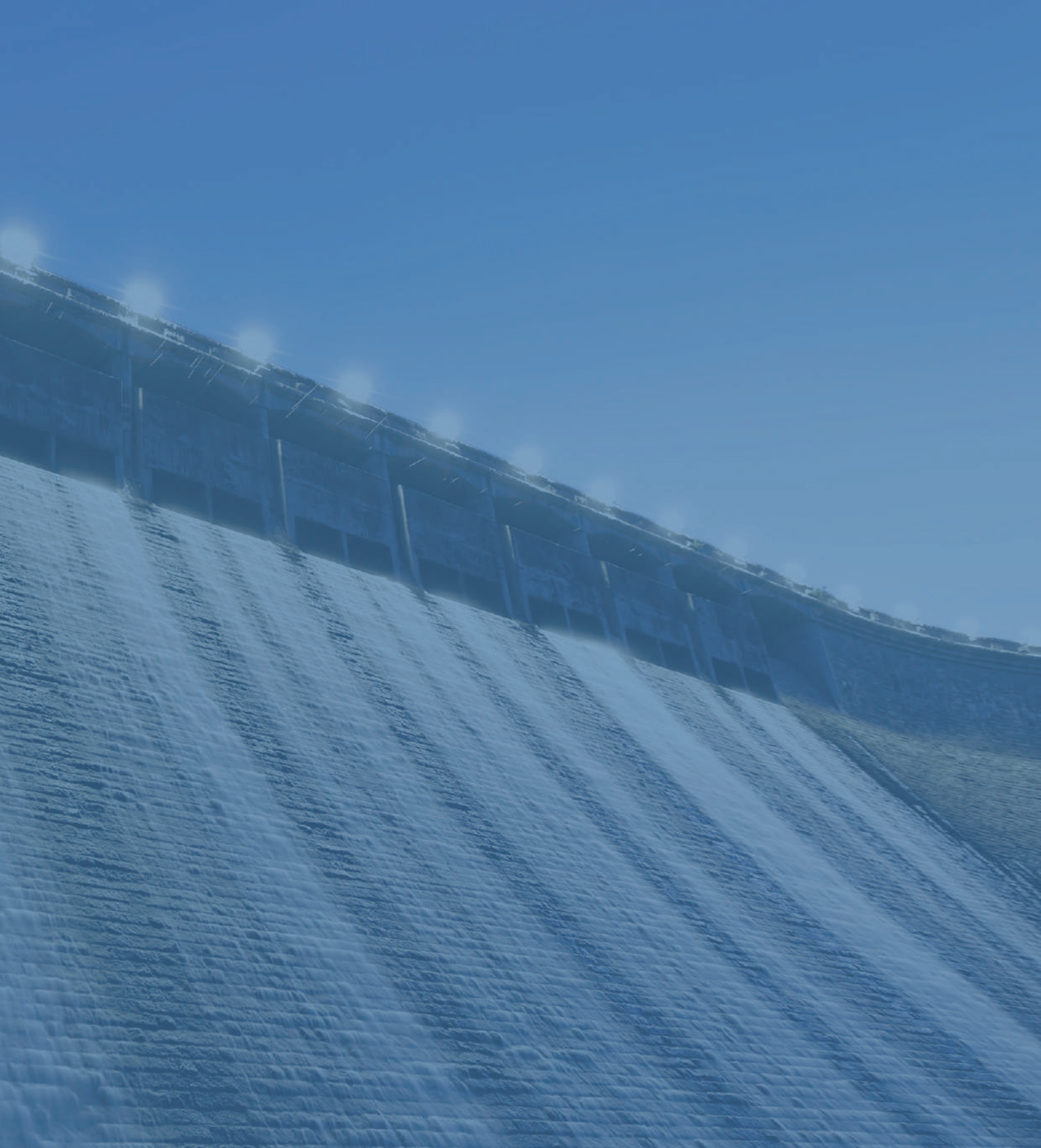

RADIANT





RADIANT

LED

Flood Light With Lens

Projecteur Avec Lentille

APPLICATION AREAS

Tunnels
Warehouses
Factories
Sport Areas
Outdoor Lighting
Open-air Car Park

DOMAINES D'UTILISATION

Tunnels
Hangars de Stockage
Usines
Complexes Sportifs
Espaces Extérieurs
Parking en Plein Air

BODY

Silver colored aluminum body with 15° - 30° rotating modules and effective cooling performance. (Rotating modules are valid for only rotating type)

LENS

Lenses with wide variety of light distribution angle options and high light transparency.

CONVERTER

IP67 converter compatible with ENEC standards.

LED

LED modules with 60.000 hours lifetime LUMILEDS / OSRAM / NICHIA brand LEDs.

CORPS

Corps en aluminum tournant module de 15° - 30° en couleur argent avec performance de refroidissement efficaces. (Les modules rotatifs ne sont valables que pour le type rotatif)

LENTILLE

Lentilles avec une grande variété d'options d'angle de distribution de lumière, et transparence de grande.

CONVERTEUR

IP67 converteur, conforme aux normes ENEC.

LED

Modules LED – Durée de vie 60.000 heures avec LED de marque LUMILEDS / OSRAM / NICHIA.

V / Hz		220 - 240 / 50 - 60	
Options	Options	NOTE	NOTE
Dimmable electronic ballast or convertor. Emergency kit	Ballast électronique dimmable ou converteur. Kit d'urgence.	Given lumen values are net delivered luminaire output lumens. Given power values are total consumed AC power of the luminaire.	Les valeurs de lumens données sont les lumens de sortie nets du luminaire. Les valeurs de puissance données sont la puissance AC totale consommée du luminaire.



Fixed Type / Type Fixes

Color Rendering Index / Indice de Rendu des Couleurs: (CRI): Ra>70

Code	Power Puissance (W)	Led Type Type De Led	Lum. Flux Flux Lum. (lm)	Color Temperature Température de couleur(K)	Dimensions (mm)			Weight Poids (kg)	Packing Quantity Colisage	Pcs./20" Container Pcs./20" Conteneur
					a	b	h			
EALPS11U	42	POWERLED	5490	2700 - 6500	85	220	117	2,0	1	4618
EALPS21U	84	POWERLED	10970	2700 - 6500	188	240	144	4,2	1	2131
EALPS31U	126	POWERLED	16460	2700 - 6500	287	240	142	4,8	1	1504
EALPS41U	168	POWERLED	21960	2700 - 6500	385	240	146	6,2	1	1162
EALPS51U	210	POWERLED	27450	2700 - 6500	485	240	152	7,7	1	900

Rotating Type / Type Tournant

Code	Power Puissance (W)	Led Type Type De Led	Lum. Flux Flux Lum. (lm)	Color Temperature Température de couleur(K)	Dimensions (mm)			Weight Poids (kg)	Packing Quantity Colisage	Pcs./20" Container Pcs./20" Conteneur
					a	b	h			
EALPH21U	84	POWERLED	10970	2700 - 6500	188	240	144	4,2	1	2131
EALPH31U	126	POWERLED	16460	2700 - 6500	287	240	142	4,8	1	1504
EALPH41U	168	POWERLED	21960	2700 - 6500	385	240	146	6,2	1	1162
EALPH51U	210	POWERLED	27450	2700 - 6500	485	240	152	7,7	1	900

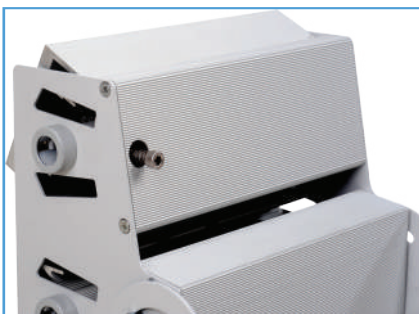

Rotating Module / Module Tournant

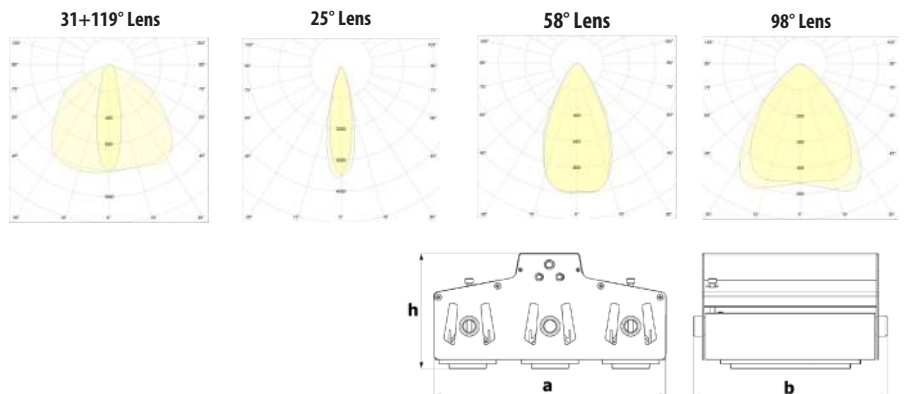



RADIANT

LED

High Bay Lighting Fixtures With Lens

Luminaire Grande Hauteur Avec Lentille

APPLICATION AREAS

Tunnels
Warehouses
Factories
Sport Areas
Outdoor Lighting
Open-air Car Park

DOMAINES D'UTILISATION

Tunnels
Hangars de Stockage
Usines
Complexes Sportifs
Espaces Exterieurs
Parking en Plein Air

BODY

Silver colored aluminum body with 15° - 30° rotating modules and effective cooling performance. (Rotating modules are valid for only rotating type)

LENS

Lenses with wide variety of light distribution angle options and high light transparency.

CONVERTER

IP67 converter compatible with ENEC standards.

LED

LED modules with 60.000 hours lifetime LUMILEDS / OSRAM / NICHIA brand LEDs.

CORPS

Corps en aluminum tournant module de 15° - 30° en couleur argent avec performance de refroidissement efficaces. (Les modules rotatifs ne sont valables que pour le type rotatif)

LENTILLE

Lentilles avec une grande variété d'options d'angle de distribution de lumière, et transparence de grande.

CONVERTEUR

IP67 converteur, conforme aux normes ENEC.

LED

Modules LED – Durée de vie 60.000 heures avec LED de marque LUMILEDS / OSRAM / NICHIA.

V / Hz		220 - 240 / 50 - 60	
Options	Options	NOTE	NOTE
Dimmable electronic ballast or convertor. Emergency kit	Ballast électronique dimmable ou converteur. Kit d'urgence.	Given lumen values are net delivered luminaire output lumens. Given power values are total consumed AC power of the luminaire.	Les valeurs de lumens données sont les lumens de sortie nets du luminaire. Les valeurs de puissance données sont la puissance AC totale consommée du luminaire.



Fixed Type / Type Fixes

Color Rendering Index / Indice de Rendu des Couleurs: (CRI): Ra>70

Code	Power Puissance (W)	Led Type Type De Led	Lum. Flux Flux Lum. (lm)	Color Temperature Température de couleur(K)	Dimensions (mm)			Weight Poids (kg)	Packing Quantity Colisage	Pcs./20" Container Pcs./20" Conteneur
					a	b	h			
EALYS13U	126	POWERLED	16460	2700 - 6500	85	730	142	4,7	1	1358
EALYS14U	168	POWERLED	21960	2700 - 6500	85	958	142	5,0	1	1049
EALYS15U	210	POWERLED	27450	2700 - 6500	85	1192	142	8,5	1	847
EALYS23U	252	POWERLED	32940	2700 - 6500	188	823	142	9,4	1	782
EALYS24U	336	POWERLED	38430	2700 - 6500	188	958	142	10,0	1	612

Rotating Type / Type Tournant

Code	Power Puissance (W)	Led Type Type De Led	Lum. Flux Flux Lum. (lm)	Color Temperature Température de couleur(K)	Dimensions (mm)			Weight Poids (kg)	Packing Quantity Colisage	Pcs./20" Container Pcs./20" Conteneur
					a	b	h			
EALYH13U	126	POWERLED	16460	2700 - 6500	85	690	142	5,3	1	1432
EALYH14U	168	POWERLED	21960	2700 - 6500	85	914	142	5,7	1	1092
EALYH15U	210	POWERLED	27450	2700 - 6500	85	1236	142	6,0	1	821



Rotating Module / Module Tournant

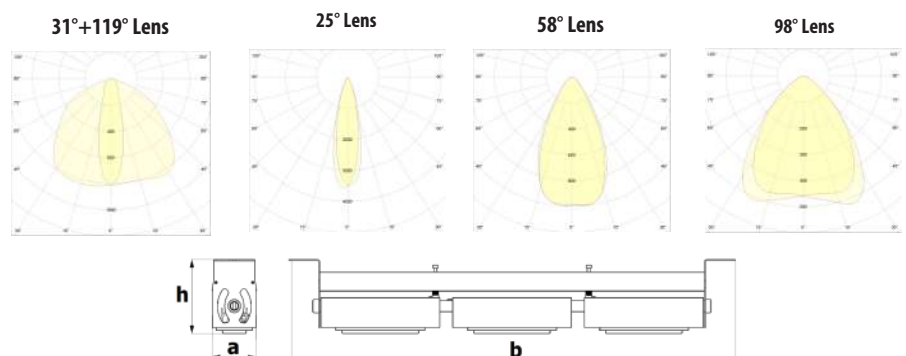



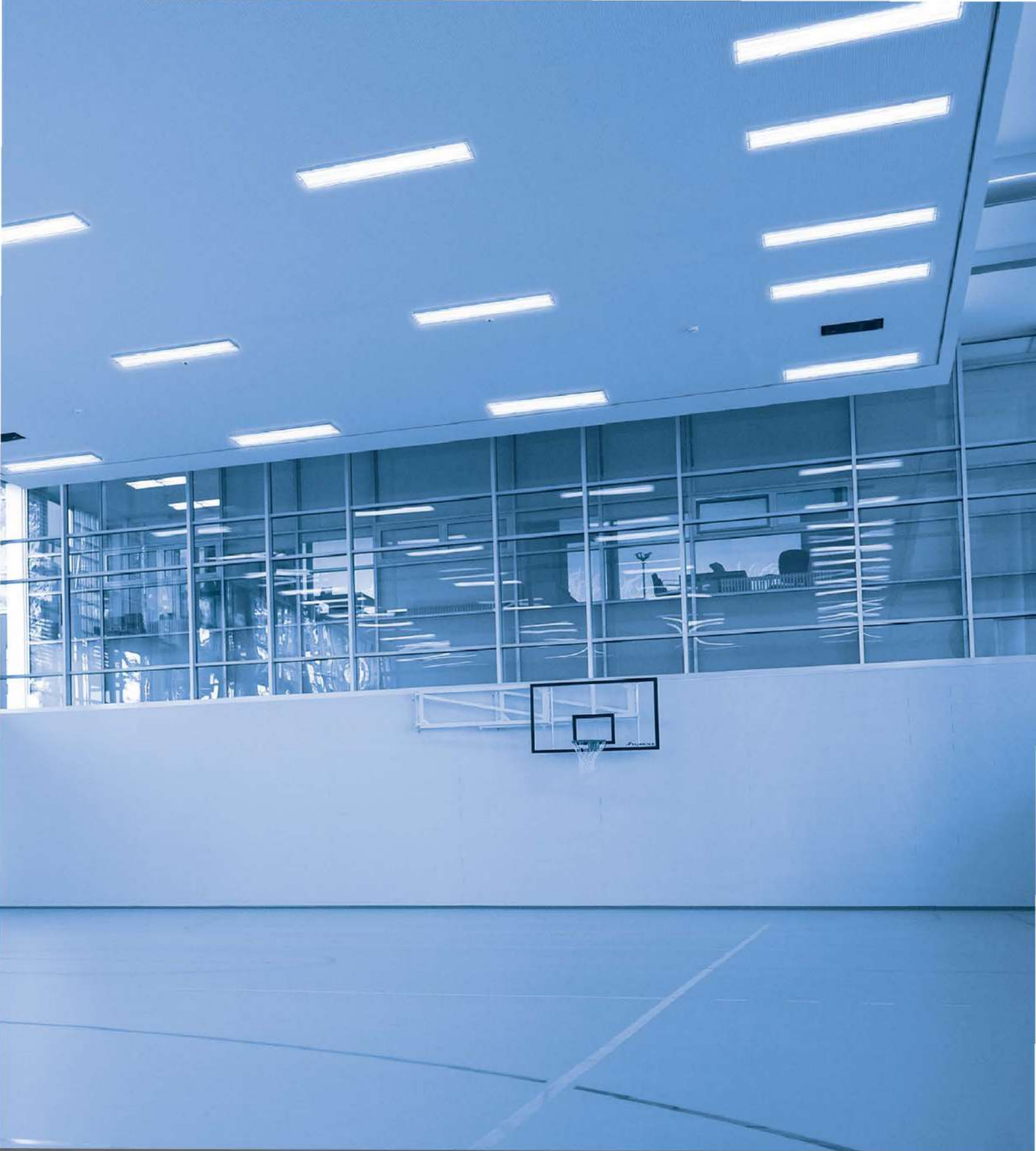

INDUSTRIAL / INDUSTRIEL

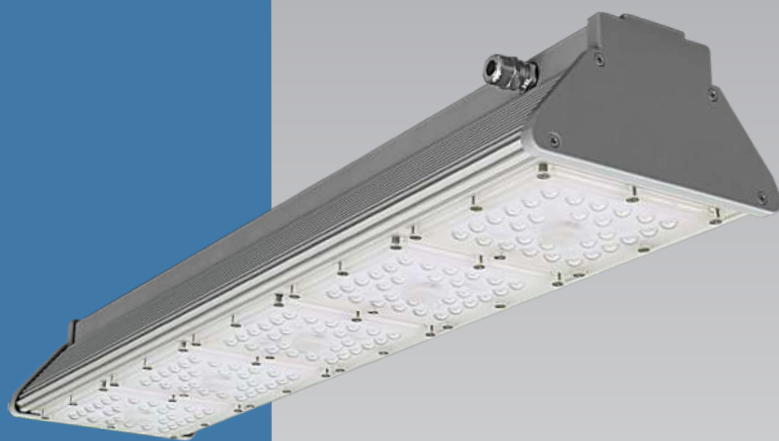

HERCULES

LED

High Bay Lighting Fixtures With Lens

Luminaires Grande Hauteur Avec Lentille

APPLICATION AREAS

Tunnels
Warehouses
Factories
Sport Areas
Outdoor Lighting
Open-air Car Park

DOMAINES D'UTILISATION

Tunnels
Hangars de Stockage
Usines
Complexes Sportifs
Espaces Exterieurs
Parking en Plein Air

BODY

Silver colored aluminum body and effective cooling performance.

LENS

Lenses with wide variety of light distribution angle options and high light transparency.

CONVERTER

Long life, low power loss converter with constant current. Compatible with ENEC standards.

LED

LED modules with 60.000 hours lifetime LUMILEDS / OSRAM / NICHIA brand LEDs.

CORPS

Corps en aluminium de couleur argentée et refroidissement efficace performance.

LENTILLE

Lentilles avec une grande variété d'options d'angle de distribution de lumière, et transparence de grande.

CONVERTEUR

Convertisseur, conforme aux normes ENEC. Longue vie. Perte de puissance faible avec courant constant .

LED

Modules LED – Durée de vie 60.000 heures avec LED de marque LUMILEDS / OSRAM / NICHIA.



LED Type / Type LED

Color Rendering Index / Indice de Rendu des Couleurs: (CRI): Ra>80

Code	Power Puissance (W)	Led Type Type De Led	Lum. Flux Flux Lum. (lm)	Color Temperature Température de couleur(K)	Dimensions (mm)			Weight Poids (kg)	Packing Quantity Colisage	Pcs./20" Container Pcs./20" Conteneur
					a	l	h			
EALH13U35L	45	POWERLED	7290	2700 - 6500	135	350	77	1,3	1	4580
EALH14U35L	60	POWERLED	9720	2700 - 6500	135	460	77	1,7	1	4320
EALH15U35L	75	POWERLED	12150	2700 - 6500	135	570	77	2,1	1	3390
EALH16U35L	90	POWERLED	14580	2700 - 6500	135	680	77	2,5	1	3150
EALH17U35L	105	POWERLED	17010	2700 - 6500	135	790	77	2,9	1	2730
EALH18U35L	120	POWERLED	19440	2700 - 6500	135	900	77	3,3	1	2175
EALH19U35L	135	POWERLED	21870	2700 - 6500	135	1010	77	3,7	1	2175
EALH110U35L	150	POWERLED	24300	2700 - 6500	135	1120	77	4,1	1	1680
EALH13U50L	66	POWERLED	10100	2700 - 6500	135	350	77	1,3	1	4580
EALH14U50L	88	POWERLED	13465	2700 - 6500	135	460	77	1,7	1	4320
EALH15U50L	110	POWERLED	16850	2700 - 6500	135	570	77	2,1	1	3390
EALH16U50L	132	POWERLED	20195	2700 - 6500	135	680	77	2,5	1	3150
EALH17U50L	154	POWERLED	23560	2700 - 6500	135	790	77	2,9	1	2730
EALH18U50L	176	POWERLED	26930	2700 - 6500	135	900	77	3,3	1	2175
EALH19U50L	198	POWERLED	30290	2700 - 6500	135	1010	77	3,7	1	2175
EALH110U50L	220	POWERLED	33660	2700 - 6500	135	1120	77	4,1	1	1680

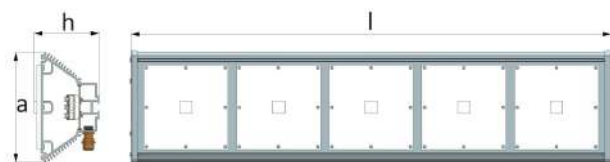

30° Lens

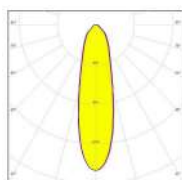

60° Lens

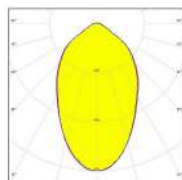

90° Lens

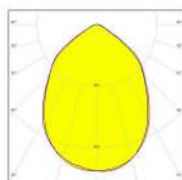

V / Hz 220 - 240 / 50 - 60

Options	Options
Dimmable electronic ballast or convertor.	Ballast électronique dimmable ou converteur.
Emergency kit	Kit d'urgence.
NOTE	NOTE
Given lumen values are net delivered luminaire output lumens.	Les valeurs de lumens données sont les lumens de sortie nets du luminaire.
Given power values are total consumed AC power of the luminaire.	Les valeurs de puissance données sont la puissance AC totale consommée du luminaire.



INDUSTRIAL HIGH BAY

LED

High Bay Lighting Fixtures

Luminaire Grande Hauteur

APPLICATION AREAS

Factories
Supermarkets
Warehouses
Stations
Subways and Tunnels
Sport Halls
Indoor Swimming
Pools

DOMAINES D'UTILISATION

Usines
Supermarchés
Hangars de stockage
Gares
Tunnels - Métros
Complexes sportifs
Piscines couvertes

BODY

RAL 9016 electrostatic powder coated sheet-metal.

GLASS

4mm tempered glass (with certificate).

REFLECTOR

Anodized aluminum with %99,9 purity and with mirror like glossy surface having high reflection performance and design enabling the efficient distribution of the light to the targeted area.

CONVERTER

Long life, low power loss converter with constant current. Compatible with ENEC standards.

LED

LED modules with 60.000 hours lifetime LUMILEDS / OSRAM / NICHIA brand LEDs.

SEAL

Thermoplastic elastomer.

CORPS

RAL 9016 Feuille de métal peinte électrostatiquement .

VERRE

4 mm verre trempé (avec certificat).

REFLECTEUR

En aluminium anodisé à 99,99% de pureté et avec une surface brillante comme un miroir , assurant un niveau élevé de réflexion. Design élégant. Permet une répartition efficace de la lumière vers l'endroit ciblé.

CONVERTEUR

Convertisseur, conforme aux normes ENEC. Longue vie. Perte de puissance faible avec courant constant .

LED

Modules LED – Durée de vie 60.000 heures avec LED de marque LUMILEDS / OSRAM / NICHIA.

JOINT

Elastomère thermoplastique.



LED Type / Type LED

Color Rendering Index / Indice de Rendu des Couleurs: (CRI): Ra>80

Code	Power Puissance (W)	LED Type Type De LED	LED Module Module LED	Lum. Flux Flux Lum. (lm)	Color Temperature Température De Couleur (K)	Dimensions (mm)			Weight Poids (kg)	Packing Quantity Colisage	Pcs./20" Container Pcs./20" Conteneur
						a	b	h			
EAL2U22L25C	40	2835 SMD	PCB	4870	2700 - 6500	225	632	73	4.0	1	1650
EAL2U32L25C	60	2835 SMD	PCB	7300	2700 - 6500	225	632	73	4.1	1	1650
EAL2U42L25C	80	2835 SMD	PCB	9740	2700 - 6500	225	632	73	4.4	1	1650
EAL2U23L25C	60	2835 SMD	PCB	7300	2700 - 6500	225	912	73	5.0	1	1200
EAL2U33L25C	90	2835 SMD	PCB	10990	2700 - 6500	225	912	73	5.2	1	1200
EAL2U43L25C	120	2835 SMD	PCB	14605	2700 - 6500	225	912	73	5.3	1	1200
EAL2U24L25C	80	2835 SMD	PCB	9740	2700 - 6500	225	1193	73	5.8	1	950
EAL2U34L25C	120	2835 SMD	PCB	14605	2700 - 6500	225	1193	73	6.0	1	950
EAL2U44L25C	160	2835 SMD	PCB	19475	2700 - 6500	225	1193	73	6.1	1	950
EAL2U25L25C	100	2835 SMD	PCB	12170	2700 - 6500	225	1473	73	7.6	1	750
EAL2U35L25C	150	2835 SMD	PCB	18255	2700 - 6500	225	1473	73	7.7	1	750
EAL2U45L25C	200	2835 SMD	PCB	24340	2700 - 6500	225	1473	73	7.8	1	750

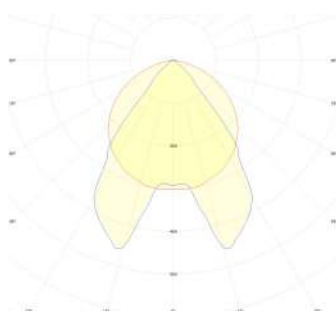

V / Hz 220 - 240 / 50 - 60

Options	Options
Dimmable electronic ballast or convertor. Emergency kit	Ballast électronique dimmable ou converteur. Kit d'urgence.
NOTE	NOTE
Given lumen values are net delivered luminaire output lumens.	Les valeurs de lumens données sont les lumens de sortie nets du luminaire.
Given power values are total consumed AC power of the luminaire.	Les valeurs de puissance données sont la puissance AC totale consommée du luminaire.





WATERPROOF / ETANCHE

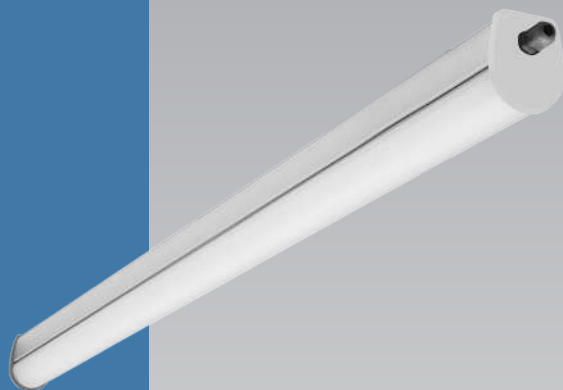

ALUMINUM WATERPROOF D'ALUMINUM ETANCHE

LED

Aluminum Waterproof Lighting Fixtures

Luminaire Etanches D'aluminium

APPLICATION AREAS

Factories
Industrial Kitchens
Laundries
Parking Areas
Outdoor Areas
Tunnels

DOMAINES D'UTILISATION

Usines
Cuisines Industrielles
Blanchisseries
Parkings
Espaces Exterieurs
Tunnels

BODY

Aluminum extrusion and corrosion resistant body.

DIFFUSER

UV stabilized extruded PC diffuser.

CEILING FIXING BRACE

Stainless steel sheet metal with 0.5 mm thickness.

CONVERTER

Long life, low power loss converter with constant current. Compatible with ENEC standards.

LED

LED modules with 60.000 hours lifetime SEOUL / LUMILEDS / NICHIA brand LEDs.

CORPS

Extrusion en aluminium et corps résistant à la corrosion.

DIFFUSEUR

Diffuseur en PC extrudé stabilisé aux UV.

ACCOLADE DE FIXATION AU PLAFOND

Feuille d'acier inoxydable de 0.5 mm d'épaisseur.

CONVERTEUR

Convertisseur, conforme aux normes ENEC. Longue vie. Perte de puissance faible avec courant constant.

LED

Modules LED – Durée de vie 60.000 heures avec LED de marque SEOUL / LUMILEDS / NICHIA.



LED Type / Type LED

Color Rendering Index / Indice de Rendu des Couleurs: (CRI): Ra>80

Code	Power Puissance (W)	LED Type Type De LED	LED Module Module LED	Lum. Flux Flux Lum. (lm)	Color Temperature Température De Couleur (K)	Dimensions (mm)			Weight Poids (kg)	Packing Quantity Colisage	Pcs./20" Container Pcs./20" Conteneur
						a	l	h			
EALAE12L15C	14	2835 SMD	PCB	1420	2700 - 6500	51	570	65	0.7	4	8000
EALAE12L25C	21	2835 SMD	PCB	2140	2700 - 6500	51	570	65	0.7	4	8000
EALAE13L15C	21	2835 SMD	PCB	2140	2700 - 6500	51	850	65	1.1	4	8000
EALAE13L25C	30	2835 SMD	PCB	3220	2700 - 6500	51	850	65	1.1	4	8000
EALAE14L15C	26	2835 SMD	PCB	2850	2700 - 6500	51	1130	65	1.4	4	5650
EALAE14L25C	41	2835 SMD	PCB	4290	2700 - 6500	51	1130	65	1.4	4	5650
EALAE15L15C	33	2835 SMD	PCB	3565	2700 - 6500	51	1412	65	1.8	4	4570
EALAE15L25C	51	2835 SMD	PCB	5365	2700 - 6500	51	1412	65	1.8	4	4570
EALAE16L15C	39	2835 SMD	PCB	4275	2700 - 6500	51	1693	65	2.1	4	4100
EALAE16L25C	61	2835 SMD	PCB	6435	2700 - 6500	51	1693	65	2.1	4	4100
EALAE17L15C	47	2835 SMD	PCB	4990	2700 - 6500	51	1973	65	2.5	4	3550
EALAE17L25C	70	2835 SMD	PCB	7510	2700 - 6500	51	1973	65	2.5	4	3550
EALAE18L15C	53	2835 SMD	PCB	5700	2700 - 6500	51	2254	65	2.8	4	3100
EALAE19L15C	60	2835 SMD	PCB	6415	2700 - 6500	51	2534	65	3.2	4	2650
EALAE10L15C	66	2835 SMD	PCB	7125	2700 - 6500	51	2815	65	3.5	4	2450

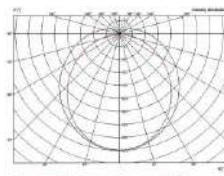
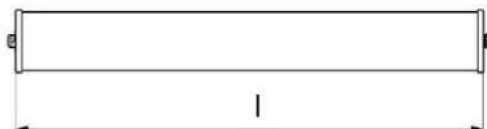
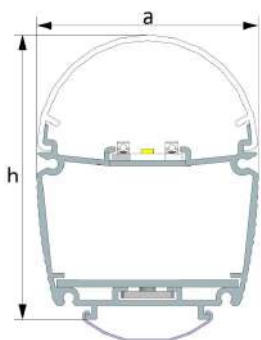

V / Hz 220 - 240 / 50 - 60

Options	Options
Dimmable electronic ballast or convertor.	Ballast électronique dimmable ou converteur.
Emergency kit for models with LED	Kit d'urgence pour les modèles LED.
NOTE	NOTE
Given lumen values are net delivered luminaire output lumens.	Les valeurs de lumens données sont les lumens de sortie nets du luminaire.
Given power values are total consumed AC power of the luminaire.	Les valeurs de puissance données sont la puissance AC totale consommée du luminaire.



FLUENT

LED

Surface Mounted Lighting Fixtures With Diffuser

Luminaire Apparents Avec Diffuseur

APPLICATION AREAS

Factories
Industrial Kitchens
Laundries
Parking Areas
Outdoor Areas
Tunnels

DOMAINES D'UTILISATION

Usines
Cuisines Industrielles
Blanchisseries
Parkings
Espaces Exterieurs
Tunnels

BODY

PC extrusion and corrosion resistant body.

DIFFUSER

UV stabilized extruded PC diffuser.

CEILING FIXING BRACE

Galvanised steel sheet metal with 0.5 mm thickness.

CONVERTER

Long life, low power loss converter with constant current. Compatible with ENEC standards.

LED

LED modules with 60.000 hours lifetime LUMILEDS / SAMSUNG / NICHIA / SEOUL.

CORPS

Extrusion en PC et corps résistant à la corrosion.

DIFFUSEUR

Diffuseur en PC extrudé stabilisé aux UV.

ACCOLADE DE FIXATION AU PLAFOND

Tôle d'acier galvanisé de 0,5 mm d'épaisseur.

CONVERTEUR

Convertisseur, conforme aux normes ENEC. Longue vie. Perte de puissance faible avec courant constant.

LED

Modules LED – Durée de vie 60.000 heures avec LED de marque LUMILEDS / SAMSUNG / NICHIA / SEOUL.

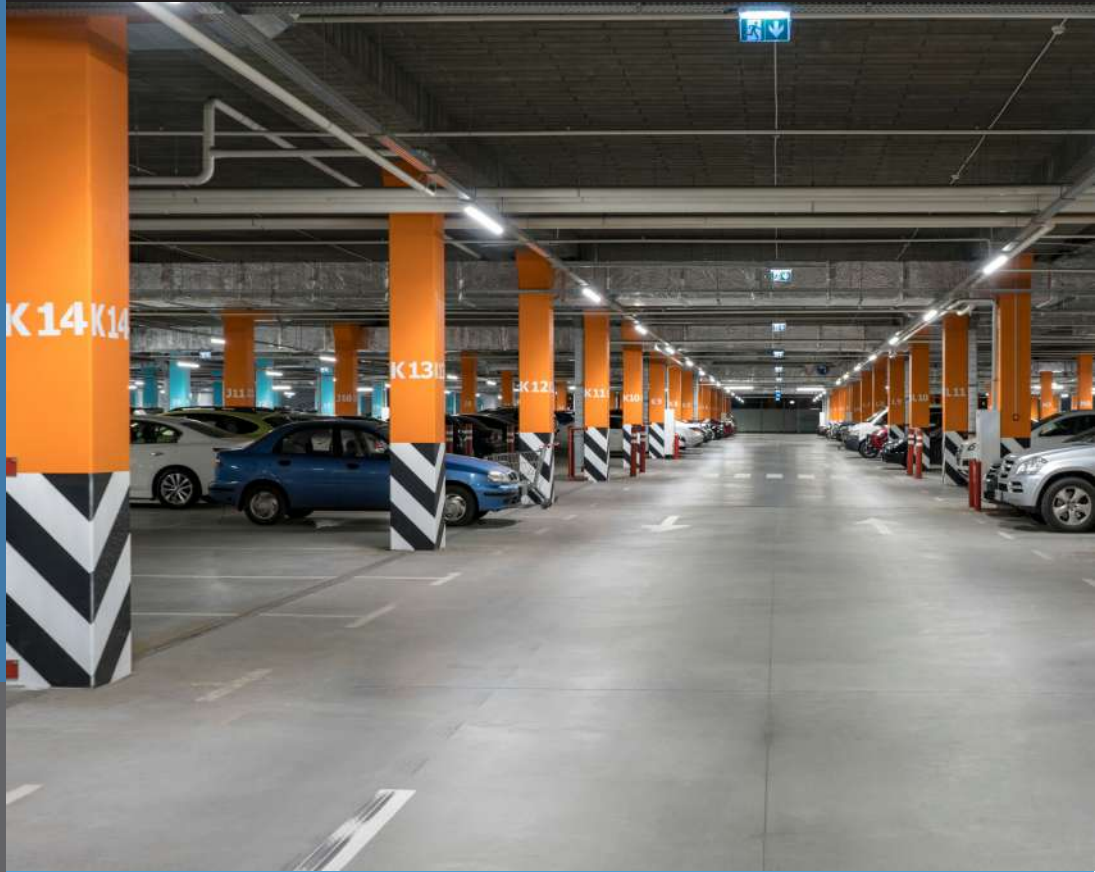

LED Type / Type LED

Color Rendering Index / Indice de Rendu des Couleurs: (CRI): Ra>80

Code	Power Puissance (W)	LED Type Type De LED	LED Module Module LED	Lum. Flux Flux Lum. (lm)	Color Temperature Température De Couleur (K)	Dimensions (mm)			Weight Poids (kg)	Packing Quantity Colisage	Pcs./20" Container Pcs./20" Conteneur
						a	l	h			
EALPE12L15C	14	2835 SMD	PCB	1540	2700 - 6500	58	575	53	0.7	9	10330
EALPE12L25C	21	2835 SMD	PCB	2315	2700 - 6500	58	575	53	0.8	9	10330
EALPE13L15C	21	2835 SMD	PCB	2310	2700 - 6500	58	853	53	1.1	9	6615
EALPE13L25C	30	2835 SMD	PCB	3475	2700 - 6500	58	853	53	1.2	9	6615
EALPE14L15C	26	2835 SMD	PCB	3080	2700 - 6500	58	1133	53	1.5	9	5165
EALPE14L25C	41	2835 SMD	PCB	4630	2700 - 6500	58	1133	53	1.6	9	5165
EALPE15L15C	33	2835 SMD	PCB	3850	2700 - 6500	58	1414	53	1.9	9	4140
EALPE15L25C	51	2835 SMD	PCB	5790	2700 - 6500	58	1414	53	2.0	9	4140
EALPE16L15C	39	2835 SMD	PCB	4620	2700 - 6500	58	1695	53	2.3	9	3420
EALPE16L25C	61	2835 SMD	PCB	6950	2700 - 6500	58	1695	53	2.4	9	3420
EALPE17L15C	47	2835 SMD	PCB	5385	2700 - 6500	58	1976	53	2.7	9	3420
EALPE17L25C	70	2835 SMD	PCB	8110	2700 - 6500	58	1976	53	2.8	9	3420
EALPE18L15C	53	2835 SMD	PCB	6155	2700 - 6500	58	2256	53	3.1	9	2790
EALPE19L15C	60	2835 SMD	PCB	6925	2700 - 6500	58	2536	53	3.5	9	2610
EALPE10L15C	66	2835 SMD	PCB	7695	2700 - 6500	58	2816	53	3.9	9	2250



V / Hz 220 - 240 / 50 - 60

Options	Options
 <p>Suspension: Composed of 1mm steel wire rope and nickel-plated brass components. Suspension height is adjustable. Supplied with transparent electric cord and ceiling mounted electrical junction box with aesthetic design.</p>	<p>Fixation: Comprend un cable en acier de 1 mm et des composants en laiton nickelé. Livré avec un cordon électrique transparent, une boîte de jonction électrique au design esthétique, à fixer au plafond.</p>

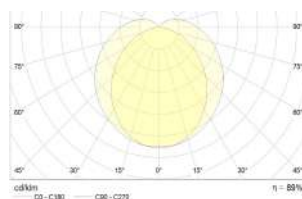

Options	Options
<p>Dimmable electronic ballast or convertor.</p> <p>Emergency kit for models with LED</p>	<p>Ballast électronique dimmable ou converteur.</p> <p>Kit d'urgence pour les modèles LED.</p>
NOTE	NOTE
<p>Given lumen values are net delivered luminaire output lumens.</p> <p>Given power values are total consumed AC power of the luminaire.</p>	<p>Les valeurs de lumens données sont les lumens de sortie nets du luminaire.</p> <p>Les valeurs de puissance données sont la puissance AC totale consommée du luminaire.</p>



WATERPROOF ETANCHE

LED

1X Waterproof Lighting Fixtures

Luminaire Etanches 1X

APPLICATION AREAS

Factories
Industrial Kitchens
Laundries
Parking Areas
Outdoor Areas
Tunnels

DOMAINES D'UTILISATION

Usines
Cuisines Industrielles
Blanchisseries
Parkings
Espaces Extérieurs
Tunnels

BODY

Polycarbonate or ABS body of gray color with polycarbonate diffuser holder.

DIFFUSER

Polycarbonate diffuser with high light transparency.

CEILING FIXING BRACE

Stainless steel sheet metal with 0.5 mm thickness.

REFLECTOR

White electrostatic powder coated, sheet metal with 0.5 mm thickness.

CONVERTER

Long life, low power loss converter with constant current. Compatible with ENEC standards.

LED

LED modules with 60.000 hours lifetime LUMILEDS / SAMSUNG / NICHIA / SEOUL brand LEDs.

CORPS

Corps gris en Polycarbonate ou ABS avec por-teur du diffuseur en polycarbonate.

DIFFUSEUR

En polycarbonate. Permet une tres grande diffusion de la lumière.

ACCOLADE DE FIXATION AU PLAFOND

Feuille d'acier inoxydable de 0.5 mm d'epaisseur.

REFLECTEUR

Feuille métallique de 0.5 mm d'épaisseur et peinte en blanc électrostatiquement.

CONVERTEUR

Convertisseur, conforme aux normes ENEC. Longue vie. Perte de puissance faible avec cou-rant constant .

LED

Modules LED – Durée de vie 60.000 heures avec LED de marque LUMILEDS / SAMSUNG / NICHIA / SEOUL.



LED Type / Type LED

Color Rendering Index / Indice de Rendu des Couleurs: (CRI): Ra>80

Code	Power Puissance (W)	LED Type Type De LED	LED Module Module LED	Lum. Flux Flux Lum. (lm)	Color Temperature Température De Couleur (K)	Dimensions (mm)			Weight Poids (kg)	Packing Quantity Colisage	Pcs./20" Container Pcs./20" Conteneur
						a	b	h			
EAL12L15C	14	2835 SMD	PCB	1635	2700 - 6500	670	95	102	1.2	9	4230
EAL14L15C	26	2835 SMD	PCB	3270	2700 - 6500	1280	95	102	2.2	6	2250
EAL15C02C	25	2835 SMD	PCB	2905	2700 - 6500	1280	95	102	2.2	6	2250
EAL15C03C	35	2835 SMD	PCB	3870	2700 - 6500	1280	95	102	2.2	6	2250
EAL15C04C	47	2835 SMD	PCB	4840	2700 - 6500	1280	95	102	2.2	6	2250

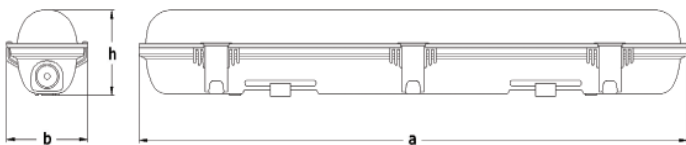

V / Hz 220 - 240 / 50 - 60

Options	Options
Dimmable electronic ballast or convertor. Emergency kit for models with LED	Ballast électronique dimmable ou converteur. Kit d'urgence pour les modèles LED.
NOTE	NOTE
Given lumen values are net delivered luminaire output lumens.	Les valeurs de lumens données sont les lumens de sortie nets du luminaire.
Given power values are total consumed AC power of the luminaire.	Les valeurs de puissance données sont la puissance AC totale consommée du luminaire.

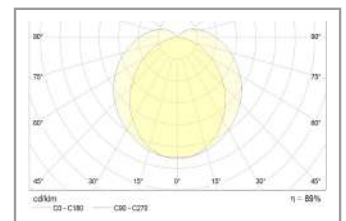
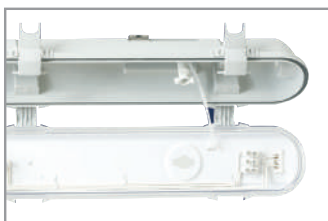



WATERPROOF ETANCHE

LED

2X Waterproof Lighting Fixtures

Luminaire Etanches 2X

APPLICATION AREAS

Factories
Industrial Kitchens
Laundries
Parking Areas
Outdoor Areas
Tunnels

DOMAINES D'UTILISATION

Usines
Cuisines Industrielles
Blanchisseries
Parkings
Espaces Extérieurs
Tunnels

BODY

Polycarbonate or ABS body of gray color with polycarbonate diffuser holder.

DIFFUSER

Polycarbonate diffuser with high light transparency.

CEILING FIXING BRACE

Stainless steel sheet metal with 0.5 mm thickness.

REFLECTOR

White electrostatic powder coated, sheet metal with 0.5 mm thickness.

CONVERTER

Long life, low power loss converter with constant current. Compatible with ENEC standards.

LED

LED modules with 60.000 hours lifetime LUMILEDS / SAMSUNG / NICHIA / SEOUL brand LEDs.

CORPS

Corps gris en Polycarbonate ou ABS avec porteur du diffuseur en polycarbonate.

DIFFUSEUR

En polycarbonate. Permet une très grande diffusion de la lumière.

ACCOLADE DE FIXATION AU PLAFOND

Feuille d'acier inoxydable de 0.5 mm d'épaisseur.

REFLECTEUR

Feuille métallique de 0.5 mm d'épaisseur et peinte en blanc électrostatiquement.

CONVERTEUR

Convertisseur, conforme aux normes ENEC. Longue vie. Perte de puissance faible avec courant constant.

LED

Modules LED – Durée de vie 60.000 heures avec LED de marque LUMILEDS / SAMSUNG / NICHIA / SEOUL.



LED Type / Type LED

Color Rendering Index / Indice de Rendu des Couleurs: (CRI): Ra>80

Code	Power Puissance (W)	LED Type Type De LED	LED Module Module LED	Lum. Flux Flux Lum. (lm)	Color Temperature Température De Couleur (K)	Dimensions (mm)			Weight Poids (kg)	Packing Quantity Colisage	Pcs./20" Container Pcs./20" Conteneur
						a	b	h			
EAL22L15C	26	2835 SMD	PCB	3270	2700 - 6500	670	140	102	1.2	9	3015
EAL24L15C	53	2835 SMD	PCB	6540	2700 - 6500	1280	140	102	2.2	6	1560
EAL215C02C	50	2835 SMD	PCB	5810	2700 - 6500	1280	140	102	2.2	6	1560
EAL215C03C	70	2835 SMD	PCB	7740	2700 - 6500	1280	140	102	2.2	6	1560

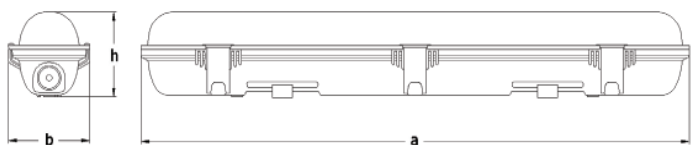

V / Hz 220 - 240 / 50 - 60

Options	Options
Dimmable electronic ballast or convertor.	Ballast électronique dimmable ou converteur.
Emergency kit for models with LED	Kit d'urgence pour les modèles LED.
NOTE	NOTE
Given lumen values are net delivered luminaire output lumens.	Les valeurs de lumens données sont les lumens de sortie nets du luminaire.
Given power values are total consumed AC power of the luminaire.	Les valeurs de puissance données sont la puissance AC totale consommée du luminaire.

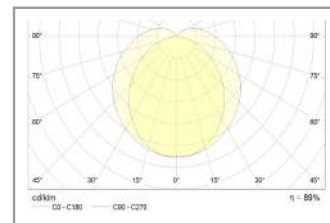
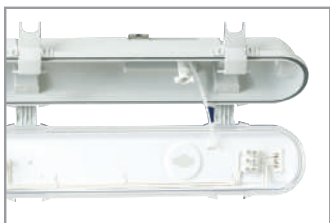



EXPROOF

WATERPROOF ETANCHE

Ex-Proof LED

Ex-Proof Waterproof
Lighting Fixtures

Luminaire Etanches Ex-Proof

APPLICATION AREAS

Factories
Refinery
Boiler Room
Fuel Stations
Fuel Filling Plants
Chemical Production

DOMAINES D'UTILISATION

Des usines
Raffinerie
Chaufferie
Stations d'essence
Usines de remplissage de carburant
Production chimique

BODY

Polycarbonate or ABS body of gray color with stainless steel diffuser holder.

DIFFUSER

Polycarbonate diffuser with high light transparency.

CEILING FIXING BRACE

Stainless steel sheet metal with 0.5 mm thickness.

REFLECTOR

White electrostatic powder coated, sheet metal with 0.5 mm thickness.

CONVERTER

Long life, low power loss converter with constant current. Compatible with ENEC standards.

CABLE GLAND

Cable gland with ATEX certification.

LED

LED modules with 60.000 hours lifetime LUMILEDS / SAMSUNG / NICHIA / SEOUL brand LEDs.

CORPS

Corps en polycarbonate ou ABS de couleur grise avec support de diffuseur en acier inoxydable.

DIFFUSEUR

En polycarbonate. Permet une tres grande diffusion de la lumière.

ACCOLADE DE FIXATION AU PLAFOND

Feuille d'acier inoxydable de 0.5 mm d'épaisseur.

REFLECTEUR

Feuille métallique de 0.5 mm d'épaisseur et peinte en blanc électrostatiquement.

CONVERTEUR

Convertisseur, conforme aux normes ENEC. Longue vie. Perte de puissance faible avec courant constant .

CABLE GLAND

Presse-étoupe avec certification ATEX.

LED

Modules LED – Durée de vie 60.000 heures avec LED de marque LUMILEDS / SAMSUNG / NICHIA / SEOUL.



LED Type / Type LED

Color Rendering Index / Indice de Rendu des Couleurs: (CRI): Ra>80

Code	Power Puissance (W)	LED Type Type De LED	LED Module Module LED	Lum. Flux Flux Lum. (lm)	Color Temperature Température De Couleur (K)	Dimensions (mm)			Weight Poids (kg)	Packing Quantity Colisage	Pcs./20" Container Pcs./20" Conteneur
						a	b	h			
EAXL22L15C	26	2835 SMD	PCB	3000	2700 - 6500	670	140	102	1.2	9	4230
EAXL22L25C	41	2835 SMD	PCB	4500	2700 - 6500	670	140	102	1.3	9	4230
EAXL14L15C	26	2835 SMD	PCB	3000	2700 - 6500	1280	95	102	1.4	6	2250
EAXL14L25C	41	2835 SMD	PCB	4500	2700 - 6500	1280	95	102	1.5	6	2250
EAXL24L15C	53	2835 SMD	PCB	6000	2700 - 6500	1280	140	102	2.2	6	1560
EAXL24L25C	80	2835 SMD	PCB	9000	2700 - 6500	1280	140	102	2.2	6	1560

V / Hz 220 - 240 / 50 - 60

Options	Options
Dimmable electronic ballast or convertor.	Ballast électronique dimmable ou converteur.
Emergency kit for models with LED	Kit d'urgence pour les modèles LED.

NOTE	NOTE
Given lumen values are net delivered luminaire output lumens.	Les valeurs de lumens données sont les lumens de sortie nets du luminaire.
Given power values are total consumed AC power of the luminaire.	Les valeurs de puissance données sont la puissance AC totale consommée du luminaire.

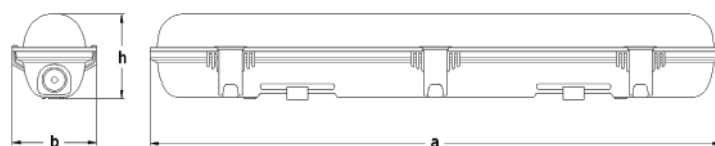





TRACK LIGHT / ÉCLAIRAGE SUR RAIL



RAY SPOT

LED

Track Light

Éclairage Sur Rail

APPLICATION AREAS

Shopping Malls
Supermarkets
Offices
Meeting rooms
Stores
Hospitals
Schools
Corridors

DOMAINES D'UTILISATION

Centres Commerciaux
Supermarchés
Bureaux
Salles de Réunion
Magasins
Hopitaux
Ecoles
Couloirs

BODY

Aluminum profile frame and injection head.

REFLECTOR

High-purity aluminum reflector; narrow, medium and wide angle options.

CONVERTER

Long life, low power loss converter with constant current. Compatible with ENEC standards.

LED

LED modules with 60.000 hours lifetime SAMSUNG / OSRAM / PHILIPS brand LEDs.

CORPS

Profilé en aluminium et tête d'injection.

REFLECTEUR

Réflecteur en aluminium de haute pureté; options d'angle étroit, moyen et large.

CONVERTEUR

Convertisseur, conforme aux normes ENEC. Longue vie. Perte de puissance faible avec courant constant.

LED

Modules LED – Durée de vie 60.000 heures avec LED de marque SAMSUNG / OSRAM / PHILIPS.



LED Type / Type LED

Color Rendering Index / Indice de Rendu des Couleurs: (CRI): Ra>80

Code	Power Puissance (W)	Led Type Type De Led	Lum. Flux Flux Lum. (lm)	Color Temperature Température De Couleur (K)	Dimensions (mm)			Weight Poids (kg)	Packing Quantity Colisage	Pcs./20" Container Pcs./20" Conteneur
					a	b	h			
PLR1U21C	21	COB	1910	2700 - 6500	118	245	302	1,50	24	12960
PLR1U28C	28	COB	2870	2700 - 6500	118	245	302	1,50	24	12960

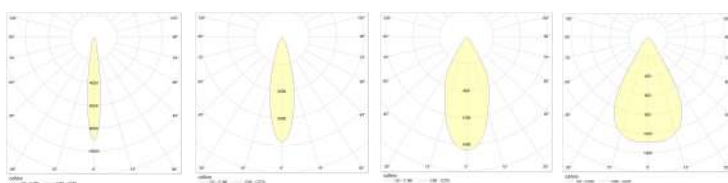
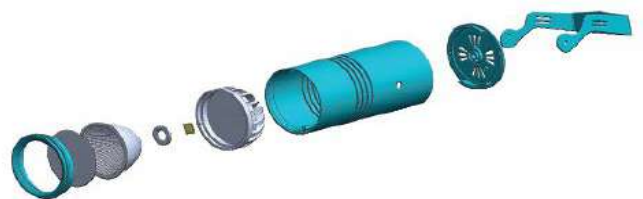
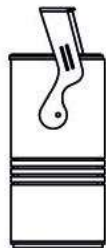
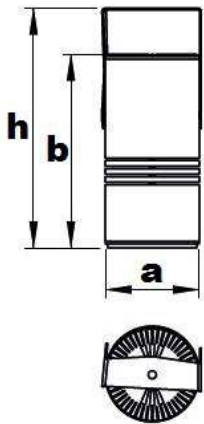

15° Reflector

30° Reflector

45° Reflector

60° Reflector

V / Hz 220 - 240 / 50 - 60

Options	Options
Dimmable electronic ballast or convertor.	Ballast électronique dimmable ou converteur.
Emergency kit for models with LED	Kit d'urgence pour les modèles LED.
NOTE	NOTE
Given lumen values are net delivered luminaire output lumens.	Les valeurs de lumens données sont les lumens de sortie nets du luminaire.
Given power values are total consumed AC power of the luminaire.	Les valeurs de puissance données sont la puissance AC totale consommée du luminaire.



RAY SPOT

LED

Track Light

Éclairage Sur Rail

APPLICATION AREAS

Shopping Malls
Supermarkets
Offices
Meeting rooms
Stores
Hospitals
Schools
Corridors

DOMAINES D'UTILISATION

Centres Commerciaux
Supermarchés
Bureaux
Salles de Réunion
Magasins
Hopitaux
Ecoles
Couloirs

BODY

Aluminum profile frame and injection head.

REFLECTOR

High-purity aluminum reflector; narrow, medium and wide angle options.

CONVERTER

Long life, low power loss converter with constant current. Compatible with ENEC standards.

LED

LED modules with 60.000 hours lifetime SAMSUNG / OSRAM / PHILIPS brand LEDs.

CORPS

Profilé en aluminium et tête d'injection.

REFLECTEUR

Réflecteur en aluminium de haute pureté; options d'angle étroit, moyen et large.

CONVERTEUR

Convertisseur, conforme aux normes ENEC. Longue vie. Perte de puissance faible avec courant constant.

LED

Modules LED – Durée de vie 60.000 heures avec LED de marque SAMSUNG / OSRAM / PHILIPS.



LED Type / Type LED

Color Rendering Index / Indice de Rendu des Couleurs: (CRI): Ra>80

Code	Power Puissance (W)	Led Type Type De Led	Lum. Flux Flux Lum. (lm)	Color Temperature Température De Couleur (K)	Dimensions (mm)			Weight Poids (kg)	Packing Quantity Colisage	Pcs./20" Container Pcs./20" Conteneur
					a	b	h			
PLR2U21C	21	COB	1910	2700 - 6500	90	150	178	1,50	24	12960
PLR2U28C	28	COB	2870	2700 - 6500	90	150	178	1,50	24	12960
PLR2U36C	36	COB	3420	2700 - 6500	90	150	178	1,50	24	12960
PLR2U42C	42	COB	3660	2700 - 6500	90	150	178	1,50	24	12960

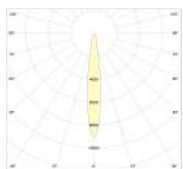
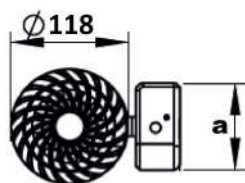
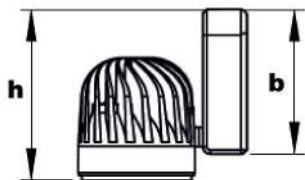

15° Reflector

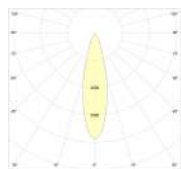

30° Reflector

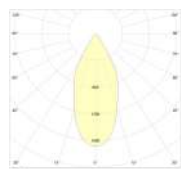

45° Reflector

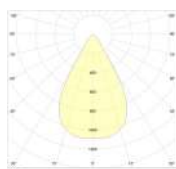

60° Reflector



V / Hz 220 - 240 / 50 - 60

Options	Options
Dimmable electronic ballast or convertor.	Ballast électronique dimmable ou converteur.
Emergency kit for models with LED	Kit d'urgence pour les modèles LED.

NOTE	NOTE
Given lumen values are net delivered luminaire output lumens.	Les valeurs de lumens données sont les lumens de sortie nets du luminaire.
Given power values are total consumed AC power of the luminaire.	Les valeurs de puissance données sont la puissance AC totale consommée du luminaire.



RAY SPOT

LED

Track Light

Éclairage Sur Rail

APPLICATION AREAS

Shopping Malls
Supermarkets
Offices
Meeting rooms
Stores
Hospitals
Schools
Corridors

DOMAINES D'UTILISATION

Centres Commerciaux
Supermarchés
Bureaux
Salles de Réunion
Magasins
Hopitaux
Ecoles
Coulors

BODY

Aluminum profile frame and injection head.

REFLECTOR

High-purity aluminum reflector; narrow, medium and wide angle options.

CONVERTER

Long life, low power loss converter with constant current. Compatible with ENEC standards.

LED

LED modules with 60.000 hours lifetime SAMSUNG / OSRAM / PHILIPS brand LEDs.

CORPS

Profilé en aluminium et tête d'injection.

REFLECTEUR

Réflecteur en aluminium de haute pureté; options d'angle étroit, moyen et large.

CONVERTEUR

Convertisseur, conforme aux normes ENEC. Longue vie. Perte de puissance faible avec courant constant.

LED

Modules LED – Durée de vie 60.000 heures avec LED de marque SAMSUNG / OSRAM / PHILIPS.



LED Type / Type LED

Color Rendering Index / Indice de Rendu des Couleurs: (CRI): Ra>80

Code	Power Puissance (W)	Led Type Type De Led	Lum. Flux Flux Lum. (lm)	Color Temperature Température De Couleur (K)	Dimensions (mm)			Weight Poids (kg)	Packing Quantity Colisage	Pcs./20" Container Pcs./20" Conteneur
					a	b	h			
PLR3U21C	21	COB	1910	2700 - 6500	100	230	260	1,25	24	10000
PLR3U28C	28	COB	2870	2700 - 6500	100	230	260	1,25	24	10000

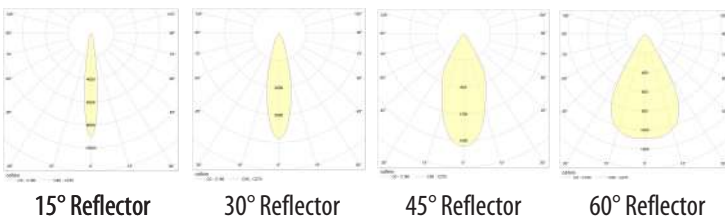
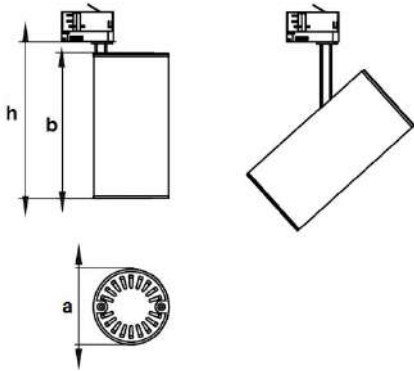

V / Hz 220 - 240 / 50 - 60

Options	Options
Dimmable electronic ballast or convertor.	Ballast électronique dimmable ou converteur.
Emergency kit for models with LED	Kit d'urgence pour les modèles LED.
NOTE	NOTE
Given lumen values are net delivered luminaire output lumens.	Les valeurs de lumens données sont les lumens de sortie nets du luminaire.
Given power values are total consumed AC power of the luminaire.	Les valeurs de puissance données sont la puissance AC totale consommée du luminaire.



RAY SPOT

LED

Track Light

Éclairage Sur Rail

APPLICATION AREAS

Shopping Malls
Supermarkets
Offices
Meeting rooms
Stores
Hospitals
Schools
Corridors

DOMAINES D'UTILISATION

Centres Commerciaux
Supermarchés
Bureaux
Salles de Réunion
Magasins
Hopitaux
Ecoles
Couloirs

BODY

Aluminum profile frame and injection head.

REFLECTOR

High-purity aluminum reflector; narrow, medium and wide angle options.

CONVERTER

Long life, low power loss converter with constant current. Compatible with ENEC standards.

LED

LED modules with 60.000 hours lifetime SAMSUNG / OSRAM / PHILIPS brand LEDs.

CORPS

Profilé en aluminium et tête d'injection.

REFLECTEUR

Réflecteur en aluminium de haute pureté; options d'angle étroit, moyen et large.

CONVERTEUR

Convertisseur, conforme aux normes ENEC. Longue vie. Perte de puissance faible avec courant constant.

LED

Modules LED – Durée de vie 60.000 heures avec LED de marque SAMSUNG / OSRAM / PHILIPS.



LED Type / Type LED

Color Rendering Index / Indice de Rendu des Couleurs: (CRI): Ra>80

Code	Power Puissance (W)	Led Type Type De Led	Lum. Flux Flux Lum. (lm)	Color Temperature Température De Couleur (K)	Dimensions (mm)			Weight Poids (kg)	Packing Quantity Colisage	Pcs./20" Container Pcs./20" Conteneur
					a	b	h			
PLR4U15C	15W	COB	1370	2700 - 6500	85	108	124	1,00	12	12000
PLR4U21C	21W	COB	1774	2700 - 6500	85	108	124	1,00	12	12000

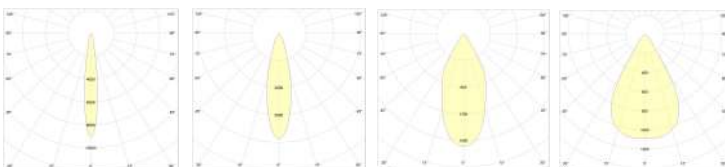
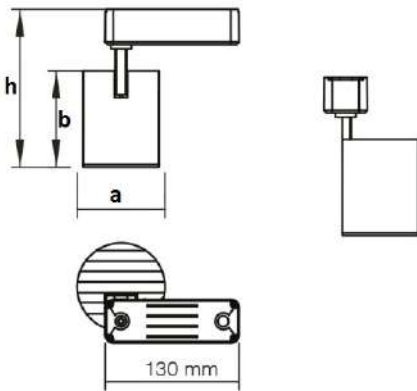

15° Reflector

30° Reflector

45° Reflector

60° Reflector

V / Hz 220 - 240 / 50 - 60

Options	Options
Dimmable electronic ballast or convertor.	Ballast électronique dimmable ou converteur.
Emergency kit for models with LED	Kit d'urgence pour les modèles LED.

NOTE	NOTE
Given lumen values are net delivered luminaire output lumens.	Les valeurs de lumens données sont les lumens de sortie nets du luminaire.
Given power values are total consumed AC power of the luminaire.	Les valeurs de puissance données sont la puissance AC totale consommée du luminaire.





DOWNLIGHTS

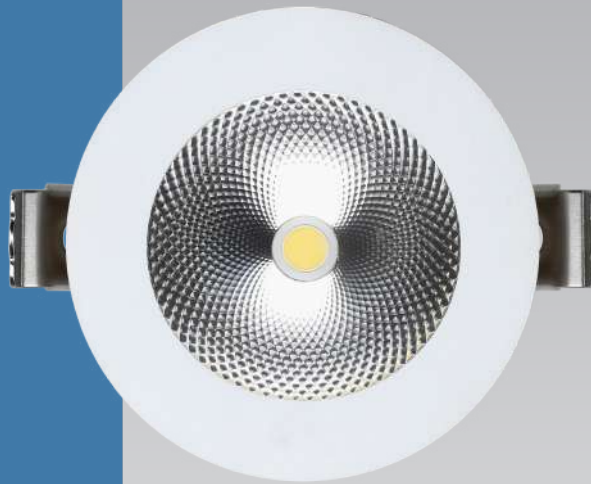

DOWNLIGHT

LED

Recessed COB Downlight

COB Encastré Downlight

APPLICATION AREAS

Shopping Malls
Supermarkets
Offices
Meeting rooms
Stores
Hospitals
Schools
Corridors

DOMAINES D'UTILISATION

Centres Commerciaux
Supermarchés
Bureaux
Salles de Réunion
Magasins
Hopitaux
Ecoles
Couloirs

BODY

White or optional any type of finishing color aluminum body and effective cooling performance.

DIFFUSER

UV stabilized transparent diffuser.

CONVERTER

Long life, low power loss converter with constant current. Compatible with ENEC standards.

LED

LED modules with 60.000 hours lifetime SAMSUNG / OSRAM / PHILIPS brand LEDs.

CORPS

Blanc ou facultatif n'importe quel type de corps en aluminium de couleur de finition et exécution efficace de refroidissement.

DIFFUSEUR

Transparent diffuseur en anti UV.

CONVERTEUR

Convertisseur, conforme aux normes ENEC. Longue vie. Perte de puissance faible avec courant constant .

LED

Modules LED – Durée de vie 60.000 heures avec LED de marque SAMSUNG / OSRAM / PHILIPS.



LED Type / Type LED

Color Rendering Index / Indice de Rendu des Couleurs: (CRI): Ra>80

Code	Power Puissance (W)	Led Type Type De Led	Lum. Flux Flux Lum. (lm)	Frame Flange Type Type de Bride de Cadre	Ceiling Cut (mm) Coupe de Plafond	Dimensions (mm) d h		Weight Poids (kg)	Packing Quantity Colisage	Pcs./20" Container Pcs./20" Conteneur
PLC1AY8C22	8	COB	900	2"	85	97	55	0,21	48	28560
PLC1AY10C325	10	COB	1170	3"	105	117	55	0,27	36	21420
PLC1AY10C425	10	COB	1170	4"	130	147	55	0,39	36	14040
PLC1AY14C435	14	COB	1920	4"	130	147	55	0,44	36	14040
PLC1AY14C535	14	COB	1950	5"	160	175	55	0,55	24	12500
PLC1AY21C55	21	COB	2300	5"	160	175	55	0,55	24	12500
PLC1AY14C635	14	COB	2000	6"	175	192	55	0,64	16	7640
PLC1AY21C65	21	COB	2700	6"	175	192	55	0,64	16	7640
PLC1AY29C67	29	COB	3400	6"	175	192	55	0,64	16	7640
PLC1AY14C835	14	COB	2100	8"	210	227	55	0,75	16	6100
PLC1AY21C85	21	COB	2800	8"	210	227	55	0,75	16	6100
PLC1AY29C87	29	COB	3500	8"	210	227	55	0,75	16	6100

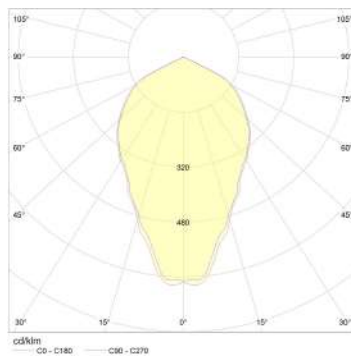
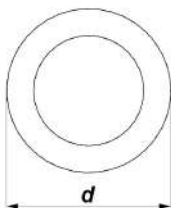
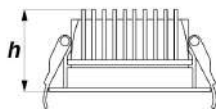

V / Hz 220 - 240 / 50 - 60

Options	Options
Dimmable electronic ballast or convertor. Emergency kit for models with LED	Ballast électronique dimmable ou converteur. Kit d'urgence pour les modèles LED.
NOTE	NOTE
Given lumen values are net delivered luminaire output lumens.	Les valeurs de lumens données sont les lumens de sortie nets du luminaire.
Given power values are total consumed AC power of the luminaire.	Les valeurs de puissance données sont la puissance AC totale consommée du luminaire.



DOWNLIGHT

LED

Recessed COB Downlight

COB Encastré Downlight

APPLICATION AREAS

Shopping Malls
Supermarkets
Offices
Meeting rooms
Stores
Hospitals
Schools
Corridors

DOMAINES D'UTILISATION

Centres Commerciaux
Supermarchés
Bureaux
Salles de Réunion
Magasins
Hopitaux
Ecoles
Couloirs

BODY

White or optional any type of finishing color aluminum body and effective cooling performance.

DIFFUSER

UV stabilized transparent diffuser.

CONVERTER

Long life, low power loss converter with constant current. Compatible with ENEC standards.

LED

LED modules with 60.000 hours lifetime SAMSUNG / OSRAM / PHILIPS brand LEDs.

CORPS

Blanc ou facultatif n'importe quel type de corps en aluminium de couleur de finition et exécution efficace de refroidissement.

DIFFUSEUR

Transparent diffuseur en anti UV.

CONVERTEUR

Convertisseur, conforme aux normes ENEC. Longue vie. Perte de puissance faible avec courant constant .

LED

Modules LED – Durée de vie 60.000 heures avec LED de marque SAMSUNG / OSRAM / PHILIPS.



LED Type / Type LED

Color Rendering Index / Indice de Rendu des Couleurs: (CRI): Ra>80

Code	Power Puissance (W)	Led Type Type De Led	Lum. Flux Flux Lum. (lm)	Frame Flange Type Type de Bride de Cadre	Ceiling Cut (mm) Coupe de Plafond	Dimensions (mm) d h	Weight Poids (kg)	Packing Quantity Colisage	Pcs./20" Container Pcs./20" Conteneur
PLC2AY8C22	8	COB	900	2"	90	108 60	0,26	36	19440
PLC2AY10C325	10	COB	1110	3"	105	128 55	0,26	36	19440
PLC2AY10C425	10	COB	1075	4"	130	150 55	0,50	16	7840
PLC2AY14C435	14	COB	1445	4"	130	150 55	0,50	16	7840
PLC2AY14C535	14	COB	1635	5"	160	180 55	0,55	16	6580
PLC2AY21C55	21	COB	2250	5"	160	180 55	0,55	16	6580
PLC2AY14C635	14	COB	1825	6"	180	200 55	0,58	16	6840
PLC2AY21C65	21	COB	2490	6"	180	200 55	0,58	16	6840
PLC2AY29C67	29	COB	3130	6"	180	200 55	0,58	16	6840
PLC2AY14C835	14	COB	1825	8"	210	240 55	0,75	16	5500
PLC2AY21C85	21	COB	2490	8"	210	240 55	0,75	16	5500
PLC2AY29C87	29	COB	3130	8"	210	240 55	0,75	16	5500

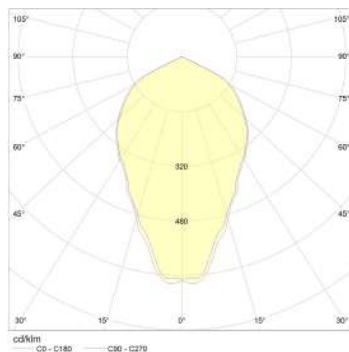
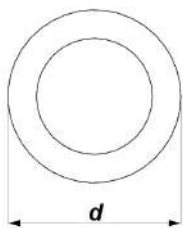
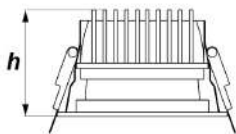

V / Hz 220 - 240 / 50 - 60

Options	Options
Dimmable electronic ballast or convertor.	Ballast électronique dimmable ou converteur.
Emergency kit for models with LED	Kit d'urgence pour les modèles LED.
NOTE	NOTE
Given lumen values are net delivered luminaire output lumens.	Les valeurs de lumens données sont les lumens de sortie nets du luminaire.
Given power values are total consumed AC power of the luminaire.	Les valeurs de puissance données sont la puissance AC totale consommée du luminaire.



SLIM DOWNLIGHT

LED

Recessed Slim Downlight

Encastré Slim Downlight

APPLICATION AREAS

Shopping Malls
Supermarkets
Offices
Meeting rooms
Stores
Hospitals
Schools
Corridors

DOMAINES D'UTILISATION

Centres Commerciaux
Supermarchés
Bureaux
Salles de Réunion
Magasins
Hopitaux
Ecoles
Couloirs

BODY

White or optional any type of finishing color aluminum body and effective cooling performance.

DIFFUSER

UV stabilized frosted diffuser.

CONVERTER

Long life, low power loss converter with constant current. Compatible with ENEC standards.

LED

LED modules with 60.000 hours lifetime LUMILEDS / SAMSUNG / CREE brand LEDs.

CORPS

Blanc ou facultatif n'importe quel type de corps en aluminium de couleur de finition et exécution efficace de refroidissement.

DIFFUSEUR

Diffuseur en anti UV.

CONVERTEUR

Convertisseur, conforme aux normes ENEC. Longue vie. Perte de puissance faible avec courant constant .

LED

Modules LED – Durée de vie 60.000 heures avec LED de marque LUMILEDS / SAMSUNG / CREE.



LED Type / Type LED

Color Rendering Index / Indice de Rendu des Couleurs: (CRI): Ra>80

Code	Power Puissance (W)	Led Type Type De Led	Lum. Flux Flux Lum. (lm)	Frame Flange Type Type de Bride de Cadre	Ceiling Cut (mm) Coupe de Plafond	Dimensions (mm) d h		Weight Poids (kg)	Packing Quantity Colisage	Pcs./20" Container Pcs./20" Conteneur
PLDS1AY10C325	10	2835 SMD	505	3"	105	128	25	0,17	36	21420
PLDS1AY11C425	11	2835 SMD	580	4"	130	150	25	0,39	36	14040
PLDS1AY15C435	15	2835 SMD	765	4"	130	150	25	0,39	36	14040
PLDS1AY19C65	19	2835 SMD	1035	6"	180	200	25	0,50	16	7640
PLDS1AY27C67	27	2835 SMD	1380	6"	180	200	25	0,50	16	7640

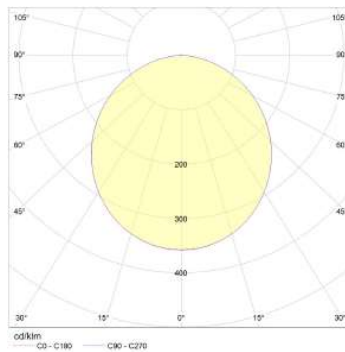
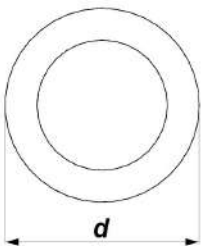
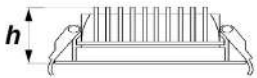

V / Hz 220 - 240 / 50 - 60

Options	Options
Dimmable electronic ballast or convertor. Emergency kit for models with LED	Ballast électronique dimmable ou convertor. Kit d'urgence pour les modèles LED.
NOTE Given lumen values are net delivered luminaire output lumens. Given power values are total consumed AC power of the luminaire.	NOTE Les valeurs de lumens données sont les lumens de sortie nets du luminaire. Les valeurs de puissance données sont la puissance AC totale consommée du luminaire.



DOWNLIGHT

LED

Recessed Slim Downlight

Encastré Slim Downlight

APPLICATION AREAS

Shopping Malls
Supermarkets
Offices
Meeting rooms
Stores
Hospitals
Schools
Corridors

DOMAINES D'UTILISATION

Centres Commerciaux
Supermarchés
Bureaux
Salles de Réunion
Magasins
Hopitaux
Ecoles
Couloirs

BODY

White or optional any type of finishing color aluminum body and effective cooling performance.

DIFFUSER

UV stabilized frosted diffuser.

CONVERTER

Long life, low power loss converter with constant current. Compatible with ENEC standards.

LED

LED modules with 60.000 hours lifetime LUMILEDS / SAMSUNG / CREE brand LEDs.

CORPS

Blanc ou facultatif n'importe quel type de corps en aluminium de couleur de finition et exécution efficace de refroidissement.

DIFFUSEUR

Diffuseur en anti UV.

CONVERTEUR

Convertisseur, conforme aux normes ENEC. Longue vie. Perte de puissance faible avec courant constant .

LED

Modules LED – Durée de vie 60.000 heures avec LED de marque LUMILEDS / SAMSUNG / CREE.



LED Type / Type LED

Color Rendering Index / Indice de Rendu des Couleurs: (CRI): Ra>80

Code	Power Puissance (W)	Led Type Type De Led	Lum. Flux Flux Lum. (lm)	Frame Flange Type Type de Bride de Cadre	Ceiling Cut (mm) Coupe de Plafond	Dimensions (mm) d h	Weight Poids (kg)	Packing Quantity Colisage	Pcs./20" Container Pcs./20" Conteneur
PLD1AY09C25	9	2835 SMD	590	2"	85	97 55	0,21	48	28560
PLD1AY10C325	10	2835 SMD	670	3"	105	117 50	0,27	36	21420
PLD1AY14C335	14	2835 SMD	860	3"	105	117 50	0,27	36	21420
PLD1AY11C425	11	2835 SMD	785	4"	130	147 55	0,39	36	14040
PLD1AY15C435	15	2835 SMD	1045	4"	130	147 55	0,44	36	14040
PLD1AY11C525	11	2835 SMD	900	5"	160	175 58	0,55	16	8640
PLD1AY15C535	15	2835 SMD	1200	5"	160	175 58	0,55	16	8640
PLD1AY19C65	19	2835 SMD	1555	6"	175	192 55	0,64	16	7640
PLD1AY27C67	27	2835 SMD	2040	6"	175	192 55	0,64	16	7640
PLD1AY19C85	19	2835 SMD	1635	8"	210	227 58	0,95	16	6240
PLD1AY27C87	27	2835 SMD	2150	8"	210	227 58	0,95	16	6240
PLD1AY30C89	30	2835 SMD	2590	8"	210	227 58	0,95	16	6240

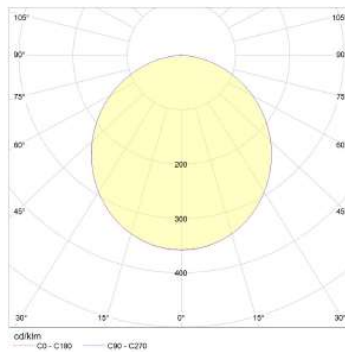
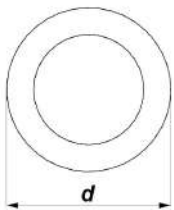
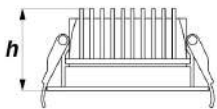

V / Hz 220 - 240 / 50 - 60

Options	Options
Dimmable electronic ballast or convertor.	Ballast électronique dimmable ou converteur.
Emergency kit for models with LED	Kit d'urgence pour les modèles LED.
NOTE	NOTE
Given lumen values are net delivered luminaire output lumens.	Les valeurs de lumens données sont les lumens de sortie nets du luminaire.
Given power values are total consumed AC power of the luminaire.	Les valeurs de puissance données sont la puissance AC totale consommée du luminaire.



DOWNLIGHT

LED

Recessed Downlight

Encastré Downlight

APPLICATION AREAS

Shopping Malls
Supermarkets
Offices
Meeting rooms
Stores
Hospitals
Schools
Corridors

DOMAINES D'UTILISATION

Centres Commerciaux
Supermarchés
Bureaux
Salles de Réunion
Magasins
Hopitaux
Ecoles
Couloirs

BODY

White or optional any type of finishing color aluminum body and effective cooling performance.

DIFFUSER

UV stabilized frosted diffuser.

CONVERTER

Long life, low power loss converter with constant current. Compatible with ENEC standards.

LED

LED modules with 60.000 hours lifetime LUMILEDS / SAMSUNG / CREE brand LEDs.

CORPS

Blanc ou facultatif n'importe quel type de corps en aluminium de couleur de finition et exécution efficace de refroidissement.

DIFFUSEUR

Diffuseur en anti UV.

CONVERTEUR

Convertisseur, conforme aux normes ENEC. Longue vie. Perte de puissance faible avec courant constant .

LED

Modules LED – Durée de vie 60.000 heures avec LED de marque LUMILEDS / SAMSUNG / CREE.



LED Type / Type LED

Color Rendering Index / Indice de Rendu des Couleurs: (CRI): Ra>80

Code	Power Puissance (W)	Led Type Type De Led	Lum. Flux Flux Lum. (lm)	Frame Flange Type Type de Bride de Cadre	Ceiling Cut (mm) Coupe de Plafond	Dimensions (mm) d h		Weight Poids (kg)	Packing Quantity Colisage	Pcs./20" Container Pcs./20" Conteneur
PLD2AY09C225	9	2835 SMD	580	2"	85	108	55	0,21	48	28560
PLD2AY10C325	10	2835 SMD	670	3"	105	130	50	0,27	36	21420
PLD2AY14C335	14	2835 SMD	845	3"	105	130	50	0,27	36	21420
PLD2AY11C425	11	2835 SMD	770	4"	130	150	55	0,39	36	14040
PLD2AY15C435	15	2835 SMD	1020	4"	130	150	55	0,44	36	14040
PLD2AY11C525	11	2835 SMD	880	5"	165	180	58	0,55	16	8640
PLD2AY15C535	15	2835 SMD	1195	5"	165	180	58	0,55	16	8640
PLD2AY19C65	19	2835 SMD	1545	6"	180	200	55	0,64	16	7640
PLD2AY27C67	27	2835 SMD	2010	6"	180	200	55	0,64	16	7640
PLD2AY19C85	19	2835 SMD	1640	8"	210	240	58	0,95	16	6240
PLD2AY27C87	27	2835 SMD	2135	8"	210	240	58	0,95	16	6240
PLD2AY30C89	30	2835 SMD	2600	8"	210	240	58	0,95	16	6240

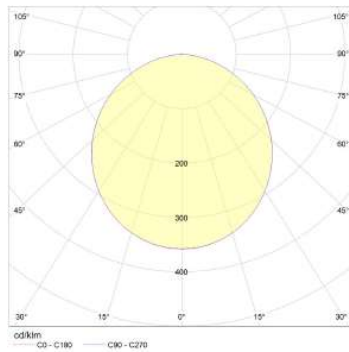
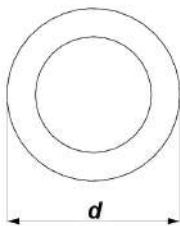
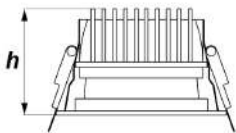

V / Hz 220 - 240 / 50 - 60

Options	Options
Dimmable electronic ballast or convertor.	Ballast électronique dimmable ou converteur.
Emergency kit for models with LED	Kit d'urgence pour les modèles LED.
NOTE	NOTE
Given lumen values are net delivered luminaire output lumens.	Les valeurs de lumens données sont les lumens de sortie nets du luminaire.
Given power values are total consumed AC power of the luminaire.	Les valeurs de puissance données sont la puissance AC totale consommée du luminaire.

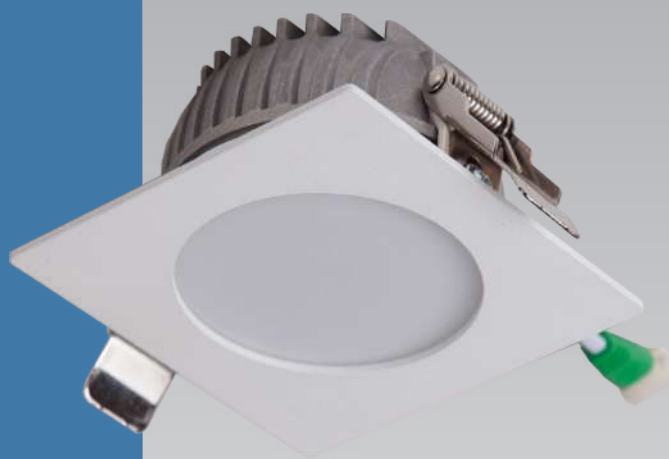

DOWNLIGHT

LED

Recessed Downlight

Encastré Downlight

APPLICATION AREAS

Shopping Malls
Supermarkets
Offices
Meeting rooms
Stores
Hospitals
Schools
Corridors

DOMAINES D'UTILISATION

Centres Commerciaux
Supermarchés
Bureaux
Salles de Réunion
Magasins
Hopitaux
Ecoles
Couloirs

BODY

White or optional any type of finishing color aluminum body and effective cooling performance.

DIFFUSER

UV stabilized frosted diffuser.

CONVERTER

Long life, low power loss converter with constant current. Compatible with ENEC standards.

LED

LED modules with 60.000 hours lifetime LUMILEDS / SAMSUNG / CREE brand LEDs.

CORPS

Blanc ou facultatif n'importe quel type de corps en aluminium de couleur de finition et exécution efficace de refroidissement.

DIFFUSEUR

Diffuseur en anti UV.

CONVERTEUR

Convertisseur, conforme aux normes ENEC. Longue vie. Perte de puissance faible avec courant constant .

LED

Modules LED – Durée de vie 60.000 heures avec LED de marque LUMILEDS / SAMSUNG / CREE.



LED Type / Type LED

Color Rendering Index / Indice de Rendu des Couleurs: (CRI): Ra>80

Code	Power Puissance (W)	Led Type Type De Led	Lum. Flux Flux Lum. (lm)	Frame Flange Type Type de Bride de Cadre	Ceiling Cut (mm) Coupe de Plafond	Dimensions (mm) a h	Weight Poids (kg)	Packing Quantity Colisage	Pcs./20" Container Pcs./20" Conteneur
PLD1AK09C225	9	2835 SMD	590	2"	85	97 55	0,21	48	28560
PLD1AK10C325	10	2835 SMD	670	3"	105	117 50	0,27	36	21420
PLD1AK14C335	14	2835 SMD	860	3"	105	117 50	0,27	36	21420
PLD1AK11C425	11	2835 SMD	785	4"	130	147 55	0,39	36	14040
PLD1AK15C435	15	2835 SMD	1045	4"	130	147 55	0,44	36	14040
PLD1AK11C525	11	2835 SMD	900	5"	160	175 58	0,55	16	8640
PLD1AK15C535	15	2835 SMD	1200	5"	160	175 58	0,55	16	8640
PLD1AK19C65	19	2835 SMD	1555	6"	175	192 55	0,64	16	7640
PLD1AK27C67	27	2835 SMD	2040	6"	175	192 55	0,64	16	7640
PLD1AK19C85	19	2835 SMD	1635	8"	210	227 58	0,95	16	6240
PLD1AK27C87	27	2835 SMD	2150	8"	210	227 58	0,95	16	6240
PLD1AK30C89	30	2835 SMD	2590	8"	210	227 58	0,95	16	6240

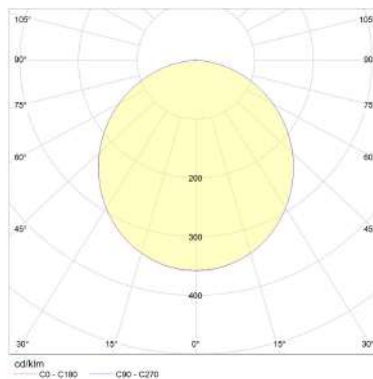
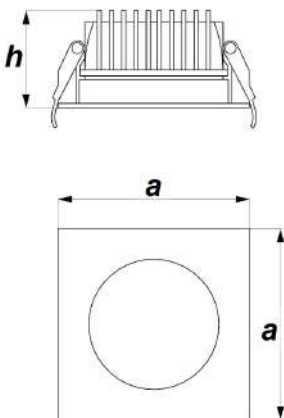

V / Hz 220 - 240 / 50 - 60

Options	Options
Dimmable electronic ballast or convertor.	Ballast électronique dimmable ou converteur.
Emergency kit for models with LED	Kit d'urgence pour les modèles LED.
NOTE	NOTE
Given lumen values are net delivered luminaire output lumens.	Les valeurs de lumens données sont les lumens de sortie nets du luminaire.
Given power values are total consumed AC power of the luminaire.	Les valeurs de puissance données sont la puissance AC totale consommée du luminaire.



DOWNLIGHT

LED

Recessed Downlight

Encastré Downlight

APPLICATION AREAS

Shopping Malls
Supermarkets
Offices
Meeting rooms
Stores
Hospitals
Schools
Corridors

DOMAINES D'UTILISATION

Centres Commerciaux
Supermarchés
Bureaux
Salles de Réunion
Magasins
Hopitaux
Ecoles
Couloirs

BODY

White or optional any type of finishing color aluminum body and effective cooling performance.

DIFFUSER

UV stabilized frosted diffuser.

CONVERTER

Long life, low power loss converter with constant current. Compatible with ENEC standards.

LED

LED modules with 60.000 hours lifetime LUMILEDS / SAMSUNG / CREE brand LEDs.

CORPS

Blanc ou facultatif n'importe quel type de corps en aluminium de couleur de finition et exécution efficace de refroidissement.

DIFFUSEUR

Diffuseur en anti UV.

CONVERTEUR

Convertisseur, conforme aux normes ENEC. Longue vie. Perte de puissance faible avec courant constant .

LED

Modules LED – Durée de vie 60.000 heures avec LED de marque LUMILEDS / SAMSUNG / CREE.



LED Type / Type LED

Color Rendering Index / Indice de Rendu des Couleurs: (CRI): Ra>80

Code	Power Puissance (W)	Led Type Type De Led	Lum. Flux Flux Lum. (lm)	Frame Flange Type Type de Bride de Cadre	Ceiling Cut (mm) Coupe de Plafond	Dimensions (mm) a h		Weight Poids (kg)	Packing Quantity Colisage	Pcs./20" Container Pcs./20" Conteneur
PLD2AK09C225	9	2835 SMD	580	2"	90	108	65	0,21	48	28560
PLD2AK10C325	10	2835 SMD	660	3"	105	128	55	0,27	36	21420
PLD2AK14C335	14	2835 SMD	860	3"	105	128	55	0,27	36	21420
PLD2AK11C425	11	2835 SMD	785	4"	130	150	55	0,39	36	14040
PLD2AK15C435	15	2835 SMD	1045	4"	130	150	55	0,44	36	14040
PLD2AK11C525	11	2835 SMD	900	5"	160	180	55	0,55	16	8640
PLD2AK15C535	15	2835 SMD	1200	5"	160	180	55	0,55	16	8640
PLD2AK19C65	19	2835 SMD	1555	6"	180	200	55	0,64	16	7640
PLD2AK27C67	27	2835 SMD	2040	6"	180	200	55	0,64	16	7640
PLD2AK19C85	19	2835 SMD	1635	8"	210	240	58	0,95	16	6240
PLD2AK27C87	27	2835 SMD	2150	8"	210	240	58	0,95	16	6240
PLD2AK30C89	30	2835 SMD	2590	8"	210	240	58	0,95	16	6240

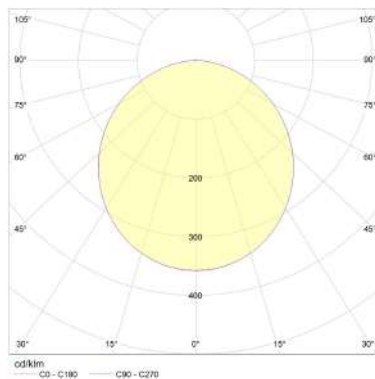
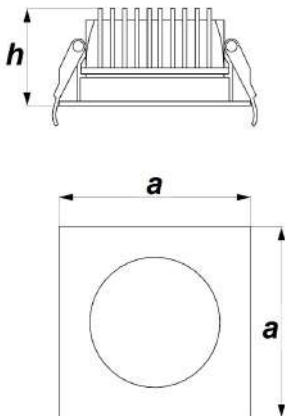

V / Hz 220 - 240 / 50 - 60

Options	Options
Dimmable electronic ballast or convertor.	Ballast électronique dimmable ou converteur.
Emergency kit for models with LED	Kit d'urgence pour les modèles LED.
NOTE	NOTE
Given lumen values are net delivered luminaire output lumens.	Les valeurs de lumens données sont les lumens de sortie nets du luminaire.
Given power values are total consumed AC power of the luminaire.	Les valeurs de puissance données sont la puissance AC totale consommée du luminaire.

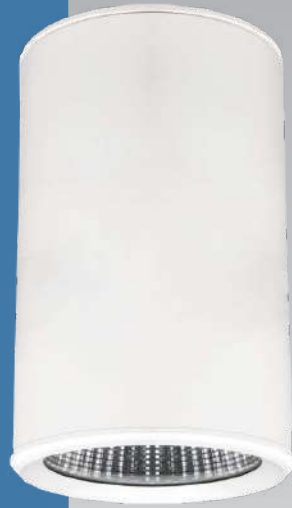

DOWNLIGHT

LED

Surface Mounted Downlight

Downlight Apparents

APPLICATION AREAS

Shopping Malls
Supermarkets
Offices
Meeting rooms
Stores
Hospitals
Schools
Corridors

DOMAINES D'UTILISATION

Centres Commerciaux
Supermarchés
Bureaux
Salles de Réunion
Magasins
Hopitaux
Ecoles
Couloirs

BODY

Aluminum profile frame and injection head.

REFLECTOR

High-purity aluminum reflector; narrow, medium and wide angle options.

CONVERTER

Long life, low power loss converter with constant current. Compatible with ENEC standards.

LED

LED modules with 60.000 hours lifetime SAMSUNG / OSRAM / PHILIPS brand LEDs.

CORPS

Profilé en aluminium et tête d'injection.

REFLECTEUR

Réflecteur en aluminium de haute pureté; options d'angle étroit, moyen et large.

CONVERTEUR

Convertisseur, conforme aux normes ENEC. Longue vie. Perte de puissance faible avec courant constant.

LED

Modules LED – Durée de vie 60.000 heures avec LED de marque SAMSUNG / OSRAM / PHILIPS.



LED Type / Type LED

Color Rendering Index / Indice de Rendu des Couleurs: (CRI): Ra>80

Code	Power Puissance (W)	Led Type Type De Led	Lum. Flux Flux Lum. (lm)	Color Temperature Température De Couleur (K)	Dimensions (mm)		Weight Poids (kg)	Packing Quantity Colisage	Pcs./20" Container Pcs./20" Conteneur
					a	h			
PLD2U21C	21	COB	1910	2700 - 6500	118	245	1,75	24	6270
PLD2U28C	28	COB	2870	2700 - 6500	118	245	1,75	24	6270

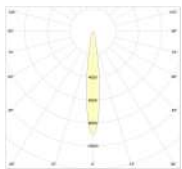
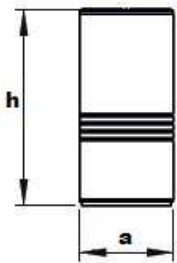

15° Reflector

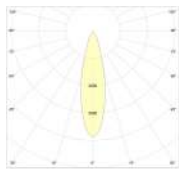

30° Reflector

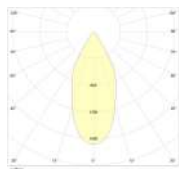

45° Reflector

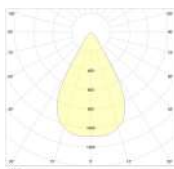

60° Reflector

V / Hz 220 - 240 / 50 - 60

Options	Options
Dimmable electronic ballast or convertor.	Ballast électronique dimmable ou converteur.
Emergency kit for models with LED	Kit d'urgence pour les modèles LED.

NOTE	NOTE
Given lumen values are net delivered luminaire output lumens.	Les valeurs de lumens données sont les lumens de sortie nets du luminaire.
Given power values are total consumed AC power of the luminaire.	Les valeurs de puissance données sont la puissance AC totale consommée du luminaire.



DOWNLIGHT

LED

Recessed Downlight

Encastré Downlight

APPLICATION AREAS

Shopping Malls
Supermarkets
Offices
Meeting rooms
Stores
Hospitals
Schools
Corridors

DOMAINES D'UTILISATION

Centres Commerciaux
Supermarchés
Bureaux
Salles de Réunion
Magasins
Hopitaux
Ecoles
Couloirs

BODY

Aluminum profile frame and injection head.

REFLECTOR

High-purity aluminum reflector; narrow, medium and wide angle options.

CONVERTER

Long life, low power loss converter with constant current. Compatible with ENEC standards.

LED

LED modules with 60.000 hours lifetime SAMSUNG / OSRAM / PHILIPS brand LEDs.

CORPS

Profilé en aluminium et tête d'injection.

REFLECTEUR

Réflecteur en aluminium de haute pureté; options d'angle étroit, moyen et large.

CONVERTEUR

Convertisseur, conforme aux normes ENEC. Longue vie. Perte de puissance faible avec courant constant.

LED

Modules LED – Durée de vie 60.000 heures avec LED de marque SAMSUNG / OSRAM / PHILIPS.



LED Type / Type LED

Color Rendering Index / Indice de Rendu des Couleurs: (CRI): Ra>80

Code	Power Puissance (W)	Led Type Type De Led	Lum. Flux Flux Lum. (lm)	Color Temperature Température De Couleur (K)	Ceiling Cut (mm) Coupe de Plafond	Dimensions (mm) a h		Weight Poids (kg)	Packing Quantity Colisage	Pcs./20° Container Pcs./20° Conteneur
PLC3A21C	21	COB	1910	2700 - 6500	170	185	146	0,75	24	4770
PLC3A28C	28	COB	2870	2700 - 6500	170	185	146	0,75	24	4770
PLC3A36C	36	COB	3420	2700 - 6500	170	185	146	0,75	24	4770

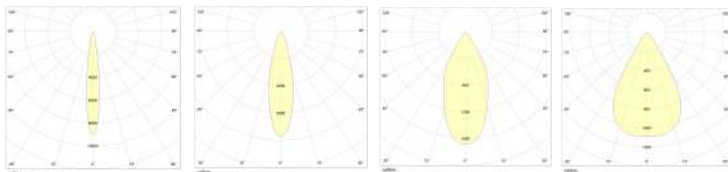
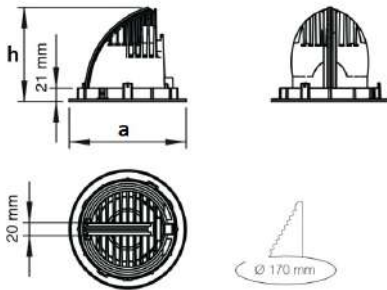

15° Reflector

30° Reflector

45° Reflector

60° Reflector

V / Hz 220 - 240 / 50 - 60

Options	Options
Dimmable electronic ballast or convertor.	Ballast électronique dimmable ou converteur.
Emergency kit for models with LED	Kit d'urgence pour les modèles LED.

NOTE	NOTE
Given lumen values are net delivered luminaire output lumens.	Les valeurs de lumens données sont les lumens de sortie nets du luminaire.
Given power values are total consumed AC power of the luminaire.	Les valeurs de puissance données sont la puissance AC totale consommée du luminaire.



DOWNLIGHT

LED

Adjustable Recessed Downlight

Réglable Encastrés Downlight

APPLICATION AREAS

Shopping Malls
Supermarkets
Offices
Meeting rooms
Stores
Hospitals
Schools
Corridors

DOMAINES D'UTILISATION

Centres Commerciaux
Supermarchés
Bureaux
Salles de Réunion
Magasins
Hopitaux
Ecoles
Couloirs

BODY

Aluminum profile frame and injection head.

REFLECTOR

High-purity aluminum reflector; narrow, medium and wide angle options.

CONVERTER

Long life, low power loss converter with constant current. Compatible with ENEC standards.

LED

LED modules with 60.000 hours lifetime SAMSUNG / OSRAM / PHILIPS brand LEDs.

CORPS

Profilé en aluminium et tête d'injection.

REFLECTEUR

Réflecteur en aluminium de haute pureté; options d'angle étroit, moyen et large.

CONVERTEUR

Convertisseur, conforme aux normes ENEC. Longue vie. Perte de puissance faible avec courant constant.

LED

Modules LED – Durée de vie 60.000 heures avec LED de marque SAMSUNG / OSRAM / PHILIPS.

V / Hz		220 - 240 / 50 - 60		NOTE	NOTE
Options	Options			Given lumen values are net delivered luminaire output lumens.	Les valeurs de lumens données sont les lumens de sortie nets du luminaire.
Dimmable electronic ballast or convertor.	Ballast électronique dimmable ou convertor.			Given power values are total consumed AC power of the luminaire.	Les valeurs de puissance données sont la puissance AC totale consommée du luminaire.
Emergency kit for models with LED	Kit d'urgence pour les modèles LED.				



LED Type / Type LED

Color Rendering Index / Indice de Rendu des Couleurs: (CRI): Ra>80

Code	Power Puissance (W)	Led Type Type De Led	Lum. Flux Flux Lum. (lm)	Color Temperature Température De Couleur (K)	Ceiling Cut (mm) Coupe de Plafond	Dimensions (mm)			Weight Poids (kg)	Packing Quantity Colisage	Pcs./20" Container Pcs./20" Conteneur
						a	b	h			
PLC2A128C	28	COB	2870	2700 - 6500	160x160	190	190	119	1,50	24	5300
PLC2A136C	36	COB	3420	2700 - 6500	160x160	190	190	119	1,50	24	5300
PLC2A228C	56	COB	5740	2700 - 6500	330x160	360	190	119	3,20	12	1550
PLC2A236C	72	COB	6840	2700 - 6500	330x160	360	190	119	3,20	12	1550
PLC2A328C	84	COB	8610	2700 - 6500	500x160	530	190	119	4,70	8	730
PLC2A336C	108	COB	10260	2700 - 6500	500x160	530	190	119	4,70	8	730

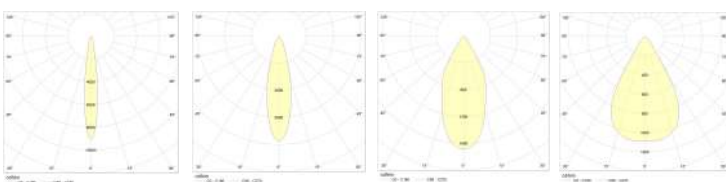
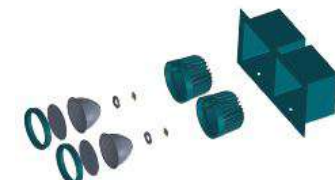
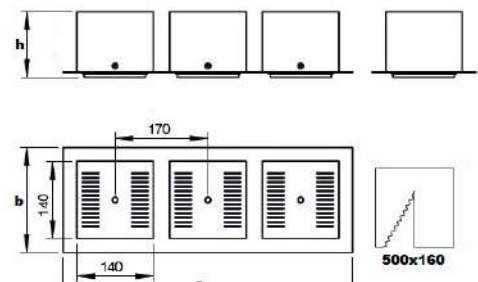
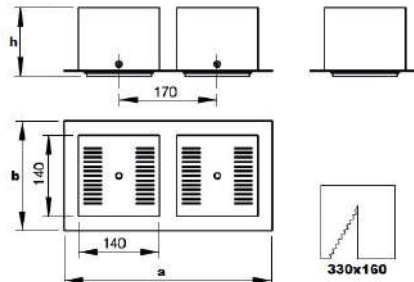
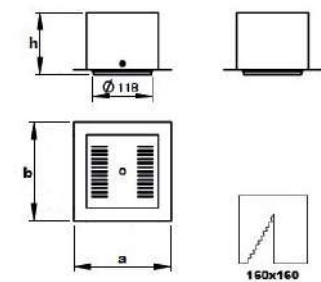

15° Reflector

30° Reflector

45° Reflector

60° Reflector



DOWNLIGHT

LED

Adjustable Surface Mounted Downlight

Réglable Apparents Downlight

APPLICATION AREAS

Shopping Malls
Supermarkets
Offices
Meeting rooms
Stores
Hospitals
Schools
Corridors

DOMAINES D'UTILISATION

Centres Commerciaux
Supermarchés
Bureaux
Salles de Réunion
Magasins
Hopitaux
Ecoles
Couloirs

BODY

Aluminum profile frame and injection head.

REFLECTOR

High-purity aluminum reflector; narrow, medium and wide angle options.

CONVERTER

Long life, low power loss converter with constant current. Compatible with ENEC standards.

LED

LED modules with 60.000 hours lifetime SAMSUNG / OSRAM / PHILIPS brand LEDs.

CORPS

Profilé en aluminium et tête d'injection.

REFLECTEUR

Réflecteur en aluminium de haute pureté; options d'angle étroit, moyen et large.

CONVERTEUR

Convertisseur, conforme aux normes ENEC. Longue vie. Perte de puissance faible avec courant constant.

LED

Modules LED – Durée de vie 60.000 heures avec LED de marque SAMSUNG / OSRAM / PHILIPS.

V / Hz 220 - 240 / 50 - 60

Options	Options	NOTE	NOTE
Dimmable electronic ballast or convertor.	Ballast électronique dimmable ou converteur.	Given lumen values are net delivered luminaire output lumens.	Les valeurs de lumens données sont les lumens de sortie nets du luminaire.
Emergency kit for models with LED	Kit d'urgence pour les modèles LED.	Given power values are total consumed AC power of the luminaire.	Les valeurs de puissance données sont la puissance AC totale consommée du luminaire.



LED Type / Type LED

Color Rendering Index / Indice de Rendu des Couleurs: (CRI): Ra>80

Code	Power Puissance (W)	Led Type Type De Led	Lum. Flux Flux Lum. (lm)	Color Temperature Température De Couleur (K)	Dimensions (mm)			Weight Poids (kg)	Packing Quantity Colisage	Pcs./20" Container Pcs./20" Conteneur
					a	b	h			
PLD3U09C	9	COB	630	2700 - 6500	97	97	100	1,50	24	20710
PLD3U17C	17	COB	1255	2700 - 6500	197	97	100	3,20	12	10850
PLD3U25C	25	COB	1890	2700 - 6500	292	97	100	4,70	8	7350

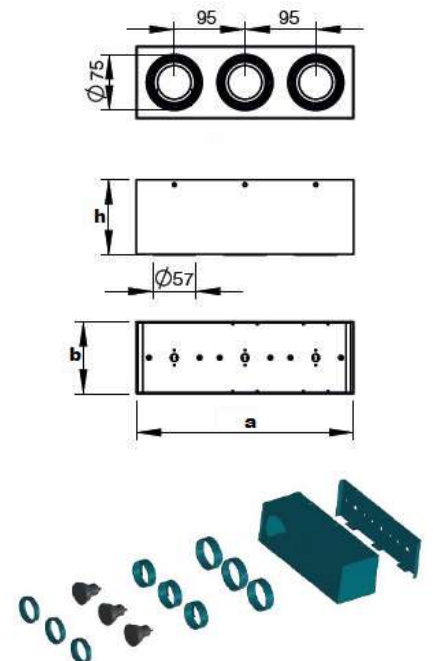
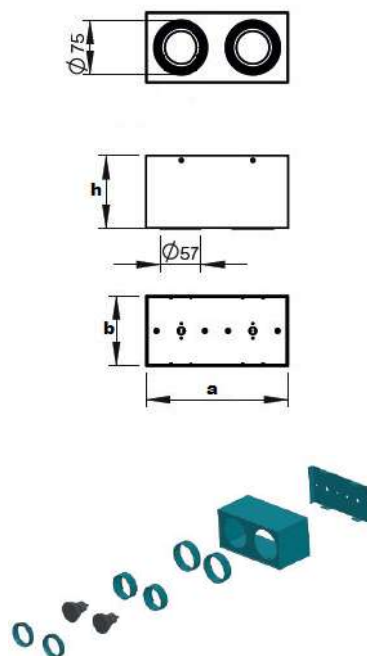
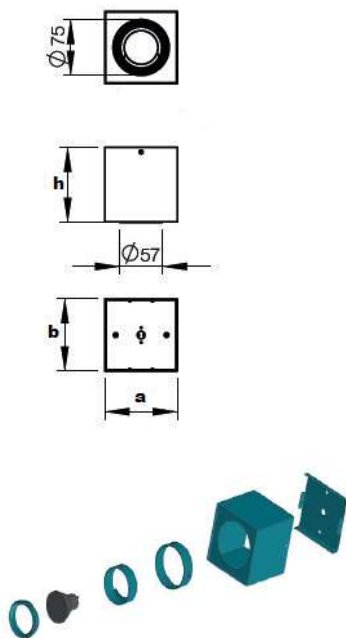



 **pamir**[®]
aydinlatma



METAL GLOP



IKONIA IP65 GLOP

LED

IP65 Glop Lamps

IP65 Hublots

APPLICATION AREAS

Building entrances
Stairways
Corridors
All other necessary places

DOMAINES D'UTILISATION

Entrées de bâtiment
Escaliers
Corridors
Et tout autre lieu si nécessaire

BODY

Injection molded polycarbonate body.

DIFFUSER

Polycarbonate opaque glass-free and soft illuminated front cover.

LED

LED modules with 50.000 hours lifetime.

CORPS

Corps en polycarbonate moulé par injection.

DIFFUSEUR

Couvercle avant en polycarbonate opaque, sans verre et à éclairage doux.

LED

Modules LED – Durée de vie 50.000 heures.



LED Type / Type LED

Color Rendering Index / Indice de Rendu des Couleurs: (CRI): Ra>80

Code	Power Puissance (W)	Color Couleur	Weight Poids (kg)	LED Type Type De LED	Dimensions (mm) d h		Specifications Caractéristiques	Pcs./20" Container Pcs./20" Conteneur
EAGLP15C	15	Gray/Gris	0,6	2835 SMD	276	100	On/Off	2700
EAGLP15CK3	15	Gray/Gris	0,7	2835 SMD	276	100	With Emergency Lighting	2700
EAGLP15CS	15	Gray/Gris	0,7	2835 SMD	276	100	With Microwave Sensor	2700
EAGLP15CSK3	15	Gray/Gris	1,0	2835 SMD	276	100	With Microwave Sensor & EM Lighting	2700
EAGLP18C	18	Gray/Gris	0,6	2835 SMD	276	100	On/Off	2700
EAGLP18CK3	18	Gray/Gris	0,7	2835 SMD	276	100	With Emergency Lighting	2700
EAGLP18CS	18	Gray/Gris	0,7	2835 SMD	276	100	With Microwave Sensor	2700
EAGLP18CSK3	18	Gray/Gris	1,0	2835 SMD	276	100	With Microwave Sensor & EM Lighting	2700
EAGLP26C	26	Gray/Gris	0,6	2835 SMD	276	100	On/Off	2700
EAGLP26CK3	26	Gray/Gris	0,7	2835 SMD	276	100	With Emergency Lighting	2700
EAGLP26CS	26	Gray/Gris	0,7	2835 SMD	276	100	With Microwave Sensor	2700
EAGLP26CSK3	26	Gray/Gris	1,0	2835 SMD	276	100	With Microwave Sensor & EM Lighting	2700

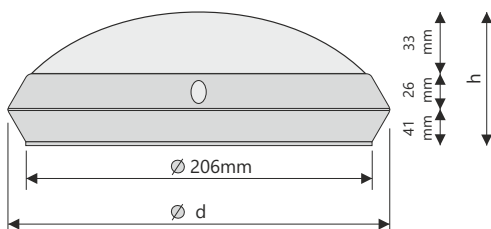

V / Hz 220 - 240 / 50 - 60

NOTE	NOTE
Given lumen values are net delivered luminaire output lumens.	Les valeurs de lumens données sont les lumens de sortie nets du luminaire.
Given power values are total consumed AC power of the luminaire.	Les valeurs de puissance données sont la puissance AC totale consommée du luminaire.



GALAKSI GLOP

LED

Glop Lamps

Hublots

APPLICATION AREAS

Building entrances
Stairways
Corridors
All other necessary places

DOMAINES D'UTILISATION

Entrées de bâtiment
Escaliers
Corridors
Et tout autre lieu si nécessaire

BODY

Anodized aluminum with satin finishing. Black and white color options with elegant design.

DIFFUSER

UV stabilized frosted diffuser.

LED

LED modules with 60.000 hours lifetime.

CORPS

Corps en aluminium anodisé, satiné. Design élégant. Couleurs blanc, noir disponibles.

VERRE

Diffuseur givré. Anti UV.

LED

Modules LED – Durée de vie 60.000 heures.



LED Type / Type LED

Color Rendering Index / Indice de Rendu des Couleurs: (CRI): Ra>80

Code	Power Puissance (W)	Lum. Flux Flux Lum. (lm)	Weight Poids (kg)	LED Type Type De LED	Dimensions (mm)		Specifications Caractéristiques	Pcs./20" Container Pcs./20" Conteneur
					d	h		
GLX-11C	11	550	0,6	2835 SMD	240	75	On/Off	5250
GLX-11CS	11	550	1,0	2835 SMD	240	75	With Radar Sensor	5250
GLX-22C	22	1100	0,7	2835 SMD	240	75	On/Off	5250

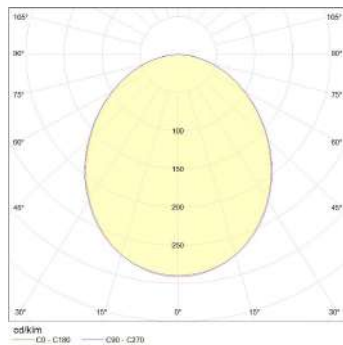
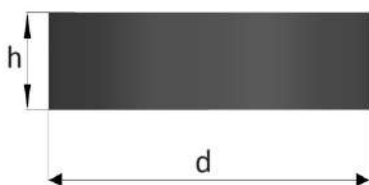

V / Hz 220 - 240 / 50 - 60

NOTE	NOTE
Given lumen values are net delivered luminaire output lumens.	Les valeurs de lumens données sont les lumens de sortie nets du luminaire.
Given power values are total consumed AC power of the luminaire.	Les valeurs de puissance données sont la puissance AC totale consommée du luminaire.



LUNA GLOP

LED

Glop Lamps

Hublots

APPLICATION AREAS

Building entrances
Stairways
Corridors
All other necessary places

DOMAINES D'UTILISATION

Entrées de bâtiment
Escaliers
Corridors
Et tout autre lieu si nécessaire

BODY

Electrostatic powder coated sheetmetal.

GLASS

Frosted PC diffuser for easy use.

LED (For LED Models)

LED modules with 30.000 hours lifetime.

CORPS

Feuille de métal peinte électrostatiquement.

VERRE

Diffuseur PC givré pour une utilisation facile.

LED (Pour Modèles LED)

Modules LED – Durée de vie 30.000 heures.

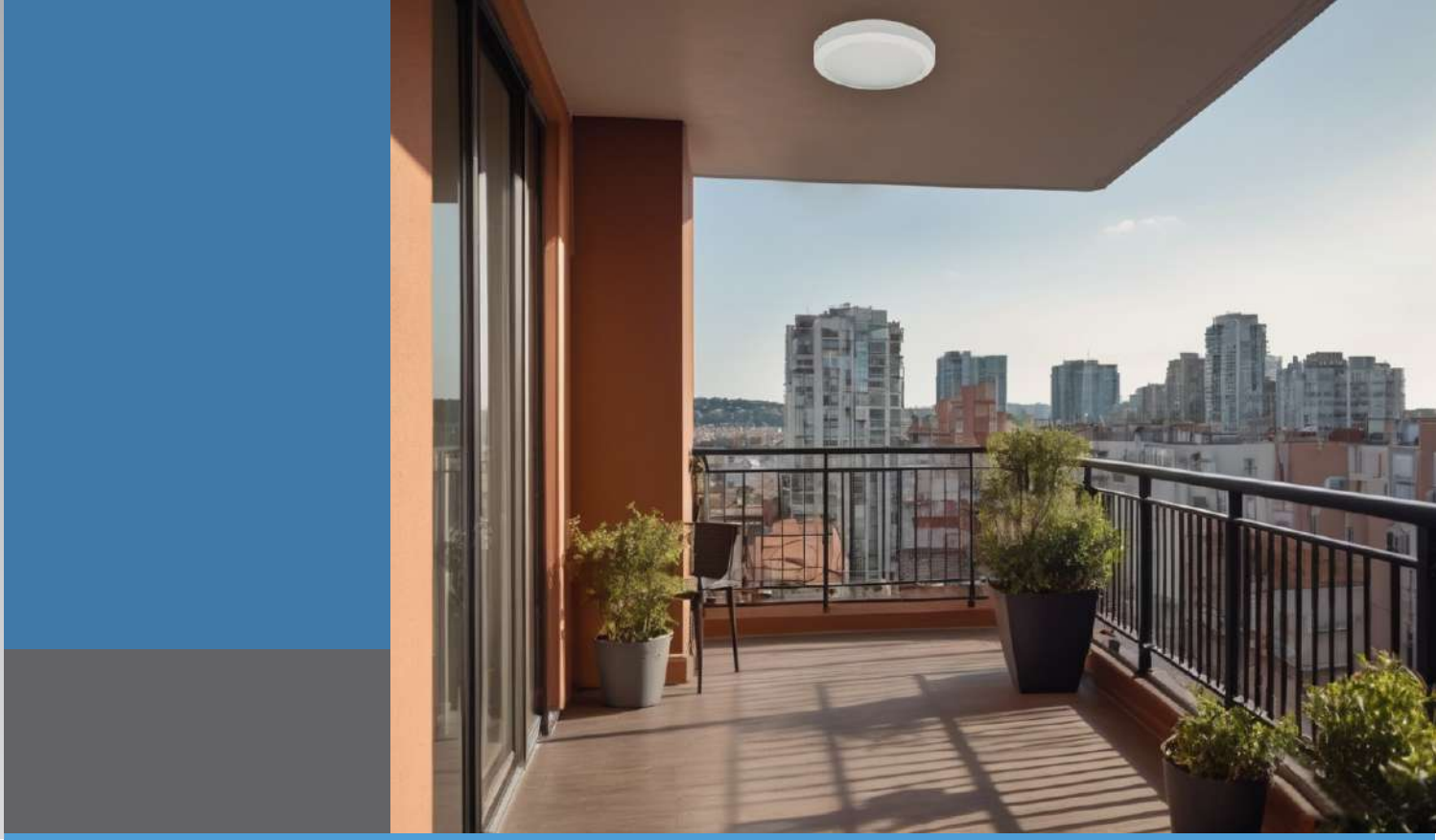

LED Type / Type LED

Code	Power Puissance (W)	Color Couleur	Weight Poids (kg)	LED Type Type De LED	Dimensions (mm) D h		Packing Quantity Colisage	Pcs./20" Container Pcs./20" Conteneur
GLP-12	12	White	1.0	2835 SMD	255	50	12	4700

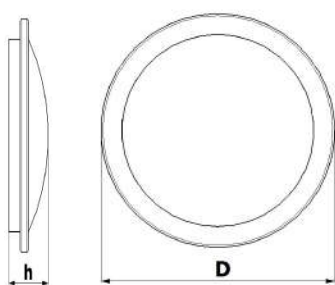

V / Hz 220 - 240 / 50 - 60

NOTE	NOTE
Given lumen values are net delivered luminaire output lumens.	Les valeurs de lumens données sont les lumens de sortie nets du luminaire.
Given power values are total consumed AC power of the luminaire.	Les valeurs de puissance données sont la puissance AC totale consommée du luminaire.



UFO GLOP

LED

Glop Lamps

Hublots

APPLICATION AREAS

Building entrances
Stairways
Corridors
All other necessary places

DOMAINES D'UTILISATION

Entrées de bâtiment
Escaliers
Corridors
Et tout autre lieu si nécessaire

BODY

RAL 9016 electrostatic powder coated sheetmetal.

GLASS

Frosted glass.

LED (For LED Models)

LED modules with 60.000 hours lifetime.

CORPS

RAL 9016 Feuille de métal peinte électrostatiquement.

VERRE

Verre givré.

LED (Pour Modèles LED)

Modules LED – Durée de vie 60.000 heures.



Bulb Type / Type d'ampoule (E-27)

Code	Power Puissance (W)	Color Couleur	Weight Poids (kg)	Socket Type Type De Douille	Dimensions (mm)		Packing Quantity Colisage	Pcs./20" Container Pcs./20" Conteneur
					D	h		
GLS-20	1x60	White/Blanc	1.1	1xE-27	280	68	12	4700

LED Type / Type LED

Code	Power Puissance (W)	Color Couleur	Weight Poids (kg)	LED Type Type De LED	Dimensions (mm)		Packing Quantity Colisage	Pcs./20" Container Pcs./20" Conteneur
					D	h		
GLS-29	12	White/Blanc	1.0	2835 SMD	280	68	12	4700
GLS-30	24	White/Blanc	1.0	2835 SMD	280	68	12	4700

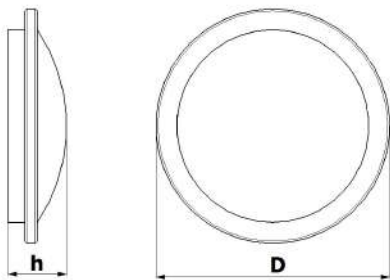

V / Hz 220 - 240 / 50 - 60

Options	Options
Dimmable electronic ballast or convertor.	Ballast électronique dimmable ou converteur.
Emergency kit for models with LED	Kit d'urgence pour les modèles LED.

NOTE	NOTE
Given lumen values are net delivered luminaire output lumens.	Les valeurs de lumens données sont les lumens de sortie nets du luminaire.
Given power values are total consumed AC power of the luminaire.	Les valeurs de puissance données sont la puissance AC totale consommée du luminaire.



 **pamir**[®]
aydınlatma





SENSOR / DÉTECTEUR





SGS 30



SGS 10 - SGS 20

LED / E27

Motion Sensor Lamp

Hublot Avec Détecteur De Mouvement

APPLICATION AREAS

Building entrances
Stairways
Corridors
All other necessary places

DOMAINES D'UTILISATION

Entrées de bâtiment
Escaliers
Corridors
Et tout autre lieu si nécessaire

BODY

RAL 9016 electrostatic powder coated sheetmetal.

DIFFUSER

UV stabilized frosted diffuser.

LED (For LED Models)

LED modules with 60.000 hours lifetime.

CORPS

RAL 9016 Feuille de métal peinte électrostatiquement.

DIFFUSEUR

Diffuseur en anti UV.

LED (Pour Modèles LED)

Modules LED – Durée de vie 60.000 heures.



Bulb Type / Type d'ampoule (E-27)

Code	Power Puissance (W)	Weight Poids (kg)	Socket Type Type De Douille	Dimensions (mm) d h		Packing Quantity Colisage	Pcs./20" Container Pcs./20" Conteneur
SGS-10	2x15	1.1	2xE-27	300	105	12	3100
SGS-10K	2x15	1.2	2xE-27	300	105	12	3100

LED Type / Type LED

Code	Power Puissance (W)	Weight Poids (kg)	LED Type Type De LED	Dimensions (mm) d h		Packing Quantity Colisage	Pcs./20" Container Pcs./20" Conteneur
SGS 20	18	1.0	2835 SMD	300	105	12	3100
SGS 20K	18	1.1	2835 SMD	300	105	12	3100
SGS 30	18	1.0	2835 SMD	300	60	12	3100
SGS 30K	18	1.1	2835 SMD	300	60	12	3100

Options	Options
Emergency kit with led.	Kit d'urgence avec led.

Technical Specifications	Spécifications Techniques
Voltage: 230V ~ 50 Hz Detection Angle: 360° Optimum Mounting Height: 3m ± 20cm Detection Width: 9m ± 40cm Time Setting: 15 - 45 sec	Voltage: 230V ~ 50 Hz Angle de Détection: 360° Hauteur Optimale de Montage: 3m ± 20cm Largeur de Détection: 9m ± 40cm Durée Réglable: 15 - 45 sec

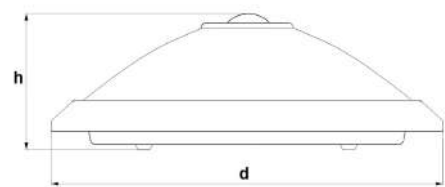

SGS10 - SGS10K - SGS20 - SGS 20K

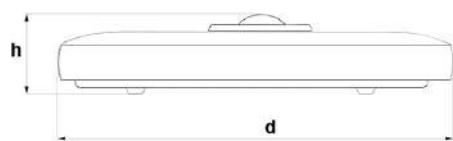

SGS30 - SGS 30K



Motion Sensor

Détecteur De Mouvement

APPLICATION AREAS

Building entrances
Stairways
Corridors
All other necessary places

DOMAINES D'UTILISATION

Entrées de bâtiment
Escaliers
Corridors
Et tout autre lieu si nécessaire

Code	Dimensions (mm)		Pcs / Inner Packing Pcs / Emballage Interne	Pcs / Outer Packing Pcs / Emballage Externe	Pcs./20" Container Pcs./20" Conteneur	Body Corps
	d	h				
SN-10	112	52	1	24	31080	ABS

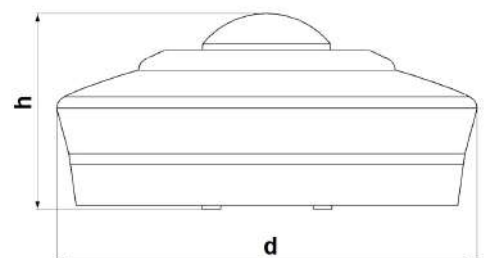



Technical Specifications	Spécifications Techniques
Voltage: 230V ~ 50 Hz IP 30 Power: Max 1500W (Incandescent Bulbs) Max 750W (Fluorescent Lamps) Detection Angle: 360° Optimum Mounting Height: 3m ± 20cm Detection Width: 14m ± 50 cm Time Setting: 8 sec - 8 min	Voltage: 230V ~ 50 Hz IP 30 Puissance: Max 1500W (Ampoules Incandescentes) Max 750W (Lampes Fluorescentes) Angle de Détection: 360° Hauteur Optimale de Montage: 3m + 20cm Largeur de Détection: 14m + 40 cm Durée Réglable: 8 sec - 8 min



SN 10





Recessed Motion Sensor Encastré Détecteur De Mouvement

APPLICATION AREAS

Building entrances
Stairways
Corridors
All other necessary
places

DOMAINES D'UTILISATION

Entrées de bâtiment
Escaliers
Corridors
Et tout autre lieu si
nécessaire

Code	Dimensions (mm)		Pcs / Inner Packing Pcs / Emballage Interne	Pcs / Outer Packing Pcs / Emballage Externe	Pcs./20" Container Pcs./20" Conteneur	Body Corps
	d	h				
SN-20	133	65	1	24	31080	ABS

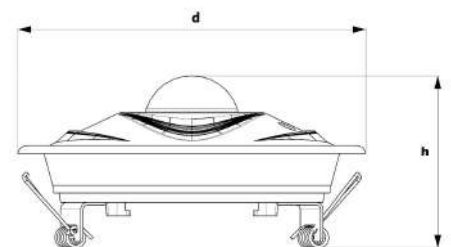



Technical Specifications	Spécifications Techniques
Voltage: 230V ~ 50 Hz IP 30 Power: Max 1500W (Incandescent Bulbs) Max 750W (Fluorescent Lamps) Detection Angle: 360° Optimum Mounting Height: 3m ± 20cm Detection Width: 8m ± 40 cm Time Setting: 8 sec - 8 min	Voltage: 230V ~ 50 Hz IP 30 Puissance: Max 1500W (Ampoules Incandescentes) Max 750W (Lampes Fluorescentes) Angle de Détection: 360° Hauteur Optimale de Montage: 3m ± 20cm Largeur de Détection: 8m ± 40 cm Durée Réglable: 8 sec - 8 min



SN 20



T.C.
TÜRK PATENT ve MARKA KURUMU
MARKA YENİLEME BELGESİ
Marka No : 2011 03288 - Ticaret - Hizmet



Marka Sahibi : PAMİR ELEKTRİK SANAYİ VE TİCARET LİMİTED ŞİRKETİ
TÜRKİYE CUMHURİYETİ
Fethi Mah. Şeyhülëma Recep Ağa Cad. No:320 Karatay Konya
Emtiası : 07 , 08 , 09 , 11 , 21 , 35
İlişiktedir.

İşbu Marka ilk defa 14/01/2011 tarihinde tescil edilmiş olup, 14/01/2021 tarihinden itibaren ON YIL süreyle yenilenmiştir.

Prof. Dr. Habip ASAN
Türk Patent ve Marka Kurumu Başkanı



T.C.
TÜRK PATENT ve MARKA KURUMU
MARKA TESCİL BELGESİ
Marka No : 2017 55300 - Ticaret - Hizmet



Marka Sahibi : PAMİR ELEKTRİK SANAYİ VE TİCARET LİMİTED ŞİRKETİ
TÜRKİYE CUMHURİYETİ
Fethi Mah. Şeyhülëma Recep Ağa Cad. No:320 Karatay Konya
Emtiası : 09 , 11 , 35
İlişiktedir.

İşbu Marka 15/06/2017 tarihinden itibaren ON YIL süreyle 25/12/2017 tarihinde tescil edilmiştir.

Prof. Dr. Habip ASAN
Türk Patent ve Marka Kurumu Başkanı



ISO 9001:2015

Kapsam/Scope

AYDINLATMA ARMATÜRLERİ, BALAST, OTOMATİK SİGORTA KUTULARI ÜRETİMİ VE SATIŞI

PRODUCTION AND SALES OF LIGHTING LUMINAIRES, BALLAST, AUTOMATIC FUSE BOXES

SERTİFİKA
CERTIFICATE

PAMİR ELEKTRİK SAN. VE TİC. LTD. ŞTİ.

FETHİ MAH. ŞEYHÜLEMA RECEPAĞA CAD. NO:262 KARATAY/KONYA/TÜRKİYE

Bu sertifika ile yukarıda adı geçen kuruluşun Kalite Yönetim Sistemi gerekliliklerini karşıladığı tasdik olunur.
This is to certify that the above mentioned Company meets the requirement of Quality Management System.

IAFK - Kategori - Teknik Alan / IAF C - Category - Technical Area	19
Uyulanabilirlik Bildirgesi / SOA	-
Sertifika No / Certification Number	MTS-35551
İlk Kayıt Tarihi / Registration Date	18.01.2024
Basım Tarihi / Issue Date	18.01.2024
Geçerlilik Tarihi / Expiry Date	17.01.2025
Belgelendirme Periyodu / Certification Period	3 yıl/3 years
Revizyon / Revision	000

- Bu sertifika kuruluşun belgelendirme şartlarına uyumlu ve yitirdiği en az bir ay süre içinde talep edilen ilave denetimler için geçerlidir.
- Sertifika geçerliliği durumu resmi internet adresimizden sorgulanabilir.
- This certificate is valid until the end of the three-year certification period if the organization complies with the certification requirements and the surveillance audits to be carried out at least once a year are completed successfully.
- The validity of the certificate can be checked on our official website.

Sigmacert Global Onay / Approved



TÜRK STANDARLARI ENSTİTÜSÜ
TÜRK STANDARLARINA UYGUNLUK BELGESİ
TURKISH STANDARDS INSTITUTION
CERTIFICATE OF CONFORMITY TO TURKISH STANDARDS

Markanın Tanımı Description of the Mark
TSE

BELGE NUMARASI
REFERENCE NUMBER OF LICENCE 004239-TSE-0107

BELGENİN İLK VERİLİŞ TARİHİ
DATE OF FIRST ISSUE OF LICENCE 01.05.2008

BELGENİN SON GEÇERLİLİK TARİHİ
LICENCE VALID UNTIL 19.03.2024

BELGE SAHİBİ KURULUŞUN ADI
NAME OF THE LICENCE HOLDER PAMİR ELEKTRİK SANAYİ VE TİCARET LTD.ŞTİ.

BELGE SAHİBİ KURULUŞUN ADRESİ
ADDRESS OF THE LICENCE HOLDER ŞEYHULEMA RECEPAĞA CAD. NO:262 KARATAY KONYA/TÜRKİYE

ÜRETİM YERİ ADI
NAME OF THE MANUFACTURING PLACE PAMİR ELEKTRİK SAN.VE TİC.LTD. ŞTİ.

ÜRETİM YERİ ADRESİ
ADDRESS OF THE MANUFACTURING PLACE ŞEYHULEMA RECEPAĞA CAD. NO:262 KARATAY KONYA / TÜRKİYE

İPTAL EDİLEN BELGE NUMARASI (Varsa)
INDICATION OF SUPERSEDED LICENCE (if any) 004239-TSE-0106

TESCİLLİ TİCARİ MARKASI
REGISTERED TRADE MARK PAMİR

İLGİLİ TÜRK STANDARDI
RELATED TURKISH STANDARD TS 8698 EN 60598-2-1 / 01.04.1996

BELGE KAPSAMI
SCOPE OF LICENCE

- 230 V, 50 Hz, I SINIFI, IP40, MIN: 1X6 W - MAX:20x12,3 W PL MODEL SERİSİ LED LAMBALARLA KULLANILAN AYDINLATMA ARMATÜRLERİ (21.07.2017 K.D.)
- 230 V, 50 Hz, I SINIFI, IP65, MIN: 2X6 W - MAX:10x12,3 W EAL MODEL SERİSİ LED LAMBALARLA KULLANILAN AYDINLATMA ARMATÜRLERİ (21.07.2017 K.D.)



e-İmzalı/signed

03.10.2023

Belgelendirme Merkezi Başkanı Adına
İZZET ŞEN

KONYA BELGELENDİRME MÜDÜRÜ

*Bu belge, belgelendiren için, üretim yerinin Enstitümüzün belletliği şartları karşılığıdır. Bu belge, hiç bir suretle tahvil edilemez, kâğıtten veya okunması zorlaştırarak pekiştirilemez, kâğıtten ve altına yazılmaz.
TSE KONYA BELGELENDİRME MÜDÜRLÜĞÜ - Adres: Organize Sanayi Bölgesi Vazirhoy Cd. Kocadere Sokak 42300 KONYA - Telefon: 0 332 239 04 80 (3H) / 239 04 84 Faks: 0 332 239 04 83
*TSE BELGELENDİRME MERKEZ BAŞKANLIĞI - Adres: Necatibey Cad. No:112 06100 Bakırçay/ANKARA - Telefon: 0 312 416 64 81 / 416 64 27. Faks: 0 312 416 66 17 E-posta: info@tse.org.tr, www.tse.org.tr



<https://evrakkontrol.tse.org.tr/BelgeDegreri.aspx?P=izmzat> adresinden belgenin doğruluğunu ve geçerliliğini sorgulayınız.

1 / 1



TÜRK STANDARLARI ENSTİTÜSÜ
TÜRK STANDARLARINA UYGUNLUK BELGESİ
TURKISH STANDARDS INSTITUTION
CERTIFICATE OF CONFORMITY TO TURKISH STANDARDS

Markanın Tanımı Description of the Mark
TSE

BELGE NUMARASI
REFERENCE NUMBER OF LICENCE 004239-TSE-04/01

BELGENİN İLK VERİLİŞ TARİHİ
DATE OF FIRST ISSUE OF LICENCE 31.01.2023

BELGENİN SON GEÇERLİLİK TARİHİ
LICENCE VALID UNTIL 31.01.2025

BELGE SAHİBİ KURULUŞUN ADI
NAME OF THE LICENCE HOLDER PAMİR ELEKTRİK SANAYİ VE TİCARET LİMİTED ŞİRKETİ

BELGE SAHİBİ KURULUŞUN ADRESİ
ADDRESS OF THE LICENCE HOLDER FETHİH MAH. ŞEYHULEMA RECEPAĞA CAD. NO:262 KARATAY KONYA/TÜRKİYE

ÜRETİM YERİ ADI
NAME OF THE MANUFACTURING PLACE PAMİR ELEKTRİK SANAYİ VE TİCARET LTD. ŞTİ.

ÜRETİM YERİ ADRESİ
ADDRESS OF THE MANUFACTURING PLACE FETHİH MH. ŞEYHULEMA RECEPAĞA CD. NO: 262 KONYA / TÜRKİYE

İPTAL EDİLEN BELGE NUMARASI (Varsa)
INDICATION OF SUPERSEDED LICENCE (if any) 2017/55300

TESCİLLİ TİCARİ MARKASI
REGISTERED TRADE MARK 2017/55300

İLGİLİ TÜRK STANDARDI
RELATED TURKISH STANDARD TS EN 60598-2-5 / 18.02.2016

BELGE KAPSAMI
SCOPE OF LICENCE

220V, 50 Hz, I SINIFI, IP 65, MIN: 40W - MAX:420 W EAL MODEL SERİSİ LED LAMBALARLA KULLANILAN AYDINLATMA ARMATÜRLERİ



e-İmzalı/signed

03.01.2024

Belgelendirme Merkezi Başkanı Adına
İZZET ŞEN

KONYA BELGELENDİRME MÜDÜRÜ

*Bu belge, belgelendiren için, üretim yerinin Enstitümüzün belletliği şartları karşılığıdır. Bu belge, hiç bir suretle tahvil edilemez, kâğıtten veya okunması zorlaştırarak pekiştirilemez, kâğıtten ve altına yazılmaz.
TSE KONYA BELGELENDİRME MÜDÜRLÜĞÜ - Adres: Organize Sanayi Bölgesi Vazirhoy Cd. Kocadere Sokak 42300 KONYA - Telefon: 0 332 239 04 80 (3H) / 239 04 84 Faks: 0 332 239 04 83
*TSE BELGELENDİRME MERKEZ BAŞKANLIĞI - Adres: Necatibey Cad. No:112 06100 Bakırçay/ANKARA - Telefon: 0 312 416 64 81 / 416 64 27. Faks: 0 312 416 66 17 E-posta: info@tse.org.tr, www.tse.org.tr



<https://evrakkontrol.tse.org.tr/BelgeDegreri.aspx?P=3jdw8k> adresinden belgenin doğruluğunu ve geçerliliğini sorgulayınız.

1 / 1



TÜRK STANDARLARI ENSTİTÜSÜ
TÜRK STANDARLARINA UYGUNLUK BELGESİ
TURKISH STANDARDS INSTITUTION
CERTIFICATE OF CONFORMITY TO TURKISH STANDARDS

Markanın Tanımı Description of the Mark
TSE

BELGE NUMARASI
REFERENCE NUMBER OF LICENCE 004239-TSE-03/07

BELGENİN İLK VERİLİŞ TARİHİ
DATE OF FIRST ISSUE OF LICENCE 28.09.2010

BELGENİN SON GEÇERLİLİK TARİHİ
LICENCE VALID UNTIL 28.09.2024

BELGE SAHİBİ KURULUŞUN ADI
NAME OF THE LICENCE HOLDER PAMİR ELEKTRİK SANAYİ VE TİCARET LTD.ŞTİ.

BELGE SAHİBİ KURULUŞUN ADRESİ
ADDRESS OF THE LICENCE HOLDER ŞEYHULEMA RECEPAĞA CAD. NO:262 KARATAY KONYA/TÜRKİYE

ÜRETİM YERİ ADI
NAME OF THE MANUFACTURING PLACE PAMİR ELEKTRİK SAN.VE TİC.LTD. ŞTİ.

ÜRETİM YERİ ADRESİ
ADDRESS OF THE MANUFACTURING PLACE ŞEYHULEMA RECEPAĞA CAD. NO:262 KARATAY KONYA / TÜRKİYE

İPTAL EDİLEN BELGE NUMARASI (Varsa)
INDICATION OF SUPERSEDED LICENCE (if any) 004239-TSE-03/06

TESCİLLİ TİCARİ MARKASI
REGISTERED TRADE MARK PAMİR

İLGİLİ TÜRK STANDARDI
RELATED TURKISH STANDARD TS EN 60598-2-2 / 05.06.2012

BELGE KAPSAMI
SCOPE OF LICENCE

- 230 V, 50 Hz, I SINIFI, IP 65, Min:1x6 W Max:20x12,3 W PL MODEL SERİSİ LED LAMBALARLA KULLANILAN AYDINLATMA ARMATÜRÜ. (31.01.2023- K.D.)

e-İmzalı/signed

31.08.2023

Belgelendirme Merkezi Başkanı Adına
İZZET ŞEN

KONYA BELGELENDİRME MÜDÜRÜ

*Bu belge, belgelendiren için, üretim yerinin Enstitümüzün belletliği şartları karşılığıdır. Bu belge, hiç bir suretle tahvil edilemez, kâğıtten veya okunması zorlaştırarak pekiştirilemez, kâğıtten ve altına yazılmaz.
TSE KONYA BELGELENDİRME MÜDÜRLÜĞÜ - Adres: Organize Sanayi Bölgesi Vazirhoy Cd. Kocadere Sokak 42300 KONYA - Telefon: 0 332 239 04 80 (3H) / 239 04 84 Faks: 0 332 239 04 83
*TSE BELGELENDİRME MERKEZ BAŞKANLIĞI - Adres: Necatibey Cad. No:112 06100 Bakırçay/ANKARA - Telefon: 0 312 416 64 81 / 416 64 27. Faks: 0 312 416 66 17 E-posta: info@tse.org.tr, www.tse.org.tr



<https://evrakkontrol.tse.org.tr/BelgeDegreri.aspx?P=4qgqfml> adresinden belgenin doğruluğunu ve geçerliliğini sorgulayınız.

1 / 1

TÜRK STANDARLARI ENSTİTÜSÜ



HİZMET YETERLİLİK BELGESİ

Belge No :42-HYB-2331

İlk Veriliş Tarihi :19.12.2019

Son Geçerlilik Tarihi :19.12.2024

Firmanın Adı :PAMİR ELEKTRİK SANAYİ VE TİCARET LTD.ŞTİ.

Firmanın Adresi :FETHİH MAH. ŞEYHULEMA RECEPAĞA CAD. NO:262 KARATAY KONYA/TÜRKİYE

Hizmet Yeri Adresi :FETHİH MAH.ŞEYHULEMA RECEPAĞA CAD.NO:262 KARATAY KONYA/TÜRKİYE

Sicil No :25938

Verilen Hizmetin Kapsamı

1. TS 13712 (27.05.2016) YETKİLİ SERVİSLER – AYDINLATMA ARMATÜRLERİ VE BALASTLARI – KURALLAR STANDARDA UYGUN HİZMET VEREN
* PAMİR ELEKTRİK SANAYİ VE TİCARET LTD. ŞTİ. YETKİLİ SERVİSİ (342991) (14.11.2019) (PAMİR AYDINLATMA,PAMİR LIGHTING) MARKALI

Türk Standartları Enstitüsü Hizmet Belgelendirme Yönergesine göre yapılan inceleme neticesinde firma aynısının, kapsamında belirtilen, hizmetler için yeterli olduğu tespit edilerek bu belge verilmiştir.

e-İmzalı/signed

20.12.2023

İZZET ŞEN

KONYA BELGELENDİRME MÜDÜRÜ



Organize Sanayi Bölgesi Vazirhoy Cd. Kocadere Sokak 42300 KONYA Telefon: 0 332 239 04 80 (3H) / 239 04 84 Faks: 0 332 239 04 83

Bu belge hiçbir suretle tahvil edilemez, kâğıtten veya okunması zorlaştırarak pekiştirilemez, kâğıtten ve altına yazılmaz. Sayfa: 1 / 1

<https://evrakkontrol.tse.org.tr/BelgeDegreri.aspx?P=4qgqfml> adresinden belgenin doğruluğunu ve geçerliliğini sorgulayınız.

Firmaya ait diğer belge için <https://evrakkontrol.tse.org.tr/CesitliFirmaArama.aspx> adresinden sorgulayabilirsiniz.



TÜRK STANDARLARI ENSTİTÜSÜ
TURKISH STANDARDS INSTITUTION



- [1] **TIP İNCELEME BELGESİ**
TYPE EXAMINATION CERTIFICATE
- [2] Muhtemel Patlayıcı Ortamda Kullanılan Teçhizat Ve Korumucu Sistemler İle İlgili Yönetmelik (2014/34/AB)
Equipment or Protective System Intended for use in Potentially Explosive Atmospheres Directive 2014/34/EU
- [3] Tip İnceleme Belgesi Numarası: **TSE 21ATEX0173 X**
Type Examination Certificate Number:
- [4] **Teçhizat/Equipment:** LED Aydınlatma Armatürü, EAXL serisi
LED Luminaire, Type: EAXL series
- [5] **Üretici/Manufacturer:** Pamir Elektrik Sanayi ve Ticaret Ltd. Şti.
- [6] **Adres/Address:** Fetih Mah. Şeyhülislam Recep Ağa Cad. No:262 Karatay Konya
- [7] Bu teçhizatın veya koruyucu sisteminin kabul edilebilir tipleri, belge ekinde ve belirtilen dokümanlarda tanımlanmıştır.
This equipment and any acceptable variation thereto is specified in the schedule to this certificate and the documents therein referred to.
- [8] Türk Standartlar Enstitüsü(TSE); 2014/34/AB sayılı yönetmeliğin Ek II bölümünde verilen "Muhtemel Patlayıcı Ortamlarda Kullanılan Teçhizat veya Korumucu Sistemlerin Tasarım ve Yapısına Dair Temel Sağlık ve Güvenlik Gereklileri" ne bu teçhizatın uygun olduğunu onaylar.
Turkish Standards Institute(TSE) certifies that this equipment or protective system has been found to comply with the Essential Health and Safety Requirements relating to the design of Category 3 equipment, which is intended for use in potentially explosive atmospheres. These Essential Health and Safety Requirements are given in Annex II to European Union Directive 2014/34/EU of 20 April 2016.
- [9] İnceleme sonuçları aşağıdaki rapor ile kayıt altına alınmıştır.
The examination and test results are recorded in confidential Report No. 2729-ATEX-202/2021-01
- [10] Temel sağlık ve güvenlik şartları gerekliliklerine uygunluk ekte belirtilenler hariç olmak üzere aşağıda belirtilen Standart(lar)a göre değerlendirilmiştir.
Compliance with the Essential Health and Safety Requirements, with the exception of those listed in the schedule of this certificate, has been assessed by reference to:
EN IEC 60079-0:2018, EN IEC 60079-7:2015/A1:2018
- [11] Eğer "X" işareti belge numarasından sonra yer alıyorsa, bu teçhizat veya koruyucu sistemin belge ekinde belirtilmiş güvenli kullanımla ilgili özel şartları kapsadığını belirtir.
If the sign "X" is placed after the certificate number, it indicates that the equipment or protective system is subject to special conditions of safe use specified in the schedule to this certificate.
- [12] 2014/34/AB Yönetmeliği EK III'e göre düzenlenen bu belge, teçhizat veya koruyucu sistemin tasarım, muayene ve testleriyle ilgilidir. Yönetmeliğin gereklileri üretimi ve bu teçhizatın veya koruyucu sisteminin tedarik edilmesine de kapsar ancak bu hususlar bu belgenin kapsamında değildir.
This Type Examination Certificate relates only to the design, examination and tests of the specified equipment or protective system in accordance to the directive 2014/34/EU. Further requirements of the Directive apply to the manufacturing process and supply of this equipment or protective system. These are not covered by this certificate.
- [13] Teçhizatın veya koruyucu sistemin işaretlemesi aşağıdakileri içermelidir.
The marking of the equipment or protective system shall include the following:

II 3G Ex ec IIC T6 Gc
-20 °C ≤ Tamb ≤ +40 °C, IP 65

SEZAI DOĞAN
Ürün Belgelendirme Grup Başkanı
Group Head of Product Certification Center
Rev:01, 15.09.2022

Proje No/Proccet Number: 2729-21/166341

Bu Tip İnceleme Belgesinin son geçerlilik tarihi:

This Type Examination Certificate is valid till: 28.12.2026

Bu belge sadece tamamını içerecek şekilde ve hiçbir değişiklik yapılmadan ekiyle birlikte çoğaltılabilir.
This certificate and its schedules may only be reproduced in its entirety and without any change.

Sayfa/Page 1 / 2

www.tse.org.tr / Necatibey Cad. No: 112 Bakanlıklar - ANKARA / +90 312 416 62 00

Bu belge hiçbir şekilde telif edilemez, kısmen veya eksik olarak çoğaltılamaz, kopyalanmaz, satılmaz ve silinmez.
This certificate cannot be altered, partially duplicated or created for misunderstanding.



TÜRK STANDARLARI ENSTİTÜSÜ
TURKISH STANDARDS INSTITUTION



- [14] **EK**
- [15] **Tip İnceleme Belgesi No: TSE 21ATEX0173 X**
TYPE EXAMINATION CERTIFICATE N°
- [16] **Teçhizatın Tanımı/ Description of Equipment:**
EAXL serisi LED aydınlatma armatürü Ex ec koruma tipine sahiptir. IECExIBE19.0029U diriver ile kullanılmaktadır. 1280 mm ve 670 mm olmak üzere iki boyutu vardır.
EAXL series LED luminaire has Ex ec protection type. It is used with the IECExIBE19.0029U driver. It has two sizes, 1280 mm and 670 mm.
Tip İşaretleme/ Type Keying:
EAXL221.15C = 26W LED BOY/ Length:670mm En/ Width:140mm H:102mm
EAXL221.25C = 41W LED BOY/ Length:670mm En/ Width:140mm H:102mm
EAXL141.15C = 26W LED BOY/ Length: 1280 mm En/ Width: 95 mm H:102mm
EAXL141.25C = 41W LED BOY/ Length: 1280 mm En/ Width: 95 mm H:102mm
EAXL241.15C = 53W LED BOY/ Length: 1280mm En/ Width:140mm H:102mm
EAXL241.25C = 80W LED BOY/ Length: 1280mm En/ Width:140mm H:102mm
Çalışma Voltajı/ Operating Voltage: 220 Vac
Frekans/ Frequency: 50 Hz
Güç/Power: 26-80 W
EAXL serisi aydınlatma armatürlerinin teknik çizimleri [19]. Bölüm Dokümantasyon Listesinde verilmiştir.
EAXL series type luminaire's technical drawings are given in [19] List of Documentation.
- [17] **Rapor Numaraları/ Test Reports:**
Temel Gerekliler Raporu: : 2729-ATEX-202/2021-01
Essential Requirements Report : TSE Ex Laboratuvarı 645038/11-21 ve 645036/11-21 nolu raporlar
Muayene ve Deneysel Raporu: *Test and Examination Report* TSE Ex laboratory 645038/11-21 and 645036/11-21 numbered reports
- [18] **Güvenli Kullanım için Özel Şartlar/ Special conditions for safe use:**
Elektrostatik yük birikmesine karşı önlemler için talimatlara bakınız.
See instructions for precautions against electrostatic charge build-up.
- [19] **Temel Sağlık ve Güvenlik Gereklileri/ Essential Health and Safety Requirements (EHSRs):**
İlgili Temel Sağlık ve Güvenlik Gereklileri [10], bölümde belirtilen standartlara göre sağlanmıştır.
The relevant EHSRs are covered by the standard mentioned in [10], according which the product was verified and in the manufacturer's instruction for use.
- [20] **Dokümantasyon Listesi/ List of Documentation:**
- | Çizim No/ Drawing No: | Sayfa Sayısı/ # of page | Rev | Tarih/ Date | Adı/ Name |
|-----------------------|-------------------------|-----|-------------|--|
| - | 4 | - | 20.10.2021 | Kısa Exproof Etanj taban / Ürün/ Cam/ Sac / Drawings (Short model) |
| - | 5 | - | 01.04.2021 | Uzun Exproof Etanj Sac/Taban / Cam / Ürün / Elektrik Bağlantı Şeması / Drawing(long) |
| - | 13 | - | - | Teknik Dosya / Technical File |
| - | - | - | 25.08.2022 | 18'i PCB Çizim / PCB Drawing |
- [21] **Belge geçmişi/ Certificate history**
28.12.2022: ilk veriliş tarihi/first issue date.
Rev:01 (15.09.2022): PCB ilgili teknik çizimine uygun olarak kaplanmadan kullanılabilir. / The PCB can be used uncoated in accordance with the relevant technical drawing.



Bu belge sadece tamamını içerecek şekilde ve hiçbir değişiklik yapılmadan ekiyle birlikte çoğaltılabilir.
This certificate and its schedules may only be reproduced in its entirety and without any change.

Veriliş Tarihi/ Date of issue: Rev:01, 15.09.2022

Sayfa/Page 2 / 2

www.tse.org.tr / Necatibey Cad. No: 112 Bakanlıklar - ANKARA / +90 312 416 62 00

Bu belge hiçbir şekilde telif edilemez, kısmen veya eksik olarak çoğaltılamaz, kopyalanmaz, satılmaz ve silinmez.
This certificate cannot be altered, partially duplicated or created for misunderstanding.



Ireland, Avalon Atrium Project



Lebanon, ABC Verdun Shopping Mall



Ireland, Consensys Fit Out Project



Türkiye, Ankara METU Infant School Project



Albania, Qendra Tregtare Univers Shopping Mall



Serbia, Supermarket Veroks Project



Türkiye, Ankara Özgata Medical Materials Pharmaceutical Industry Office



Oman, Oasis Mall Sohar



Türkiye, Bursa Koç Dialysis



Türkiye, Konya Public Library



Türkiye, Ankara Disaster Coordination Center



Egypt, Cairo Bank Misr



Türkiye, Kahramanmaraş Dorutech



Ireland, Micheal Tierney Building

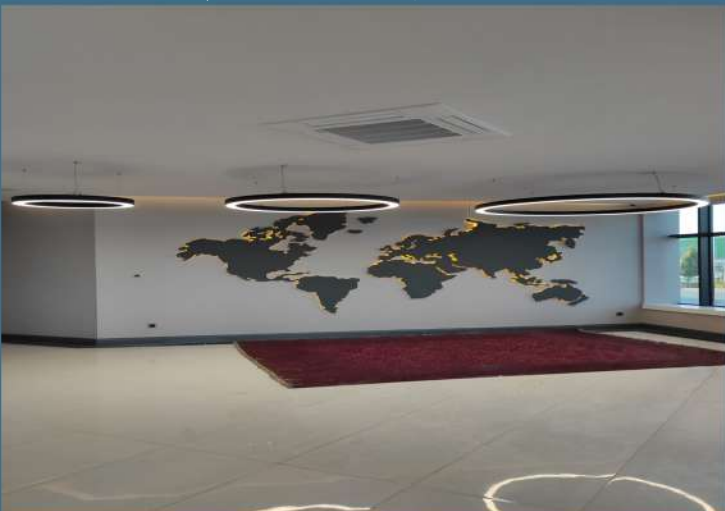

Türkiye, Gaziantep Vista Carpet



Türkiye, Çumra Torku Doğrudan Market



Head Office Factory / Direction Generale Usine

Fetih Mah. Seyhulema Recepaga Cad. No: 262 42030 Karatay - Konya / TURKEY

T: +90 332 355 86 16 - F: +90 332 355 86 12

E-mail: pamir@pamir.com.tr - www.pamir.com.tr

 [/pamir_lighting](https://www.instagram.com/pamir_lighting)

 [/PamirLighting](https://twitter.com/PamirLighting)

 [/pamirlightingfixtures](https://www.facebook.com/pamirlightingfixtures)